

# NOUAMED<sup>®</sup>

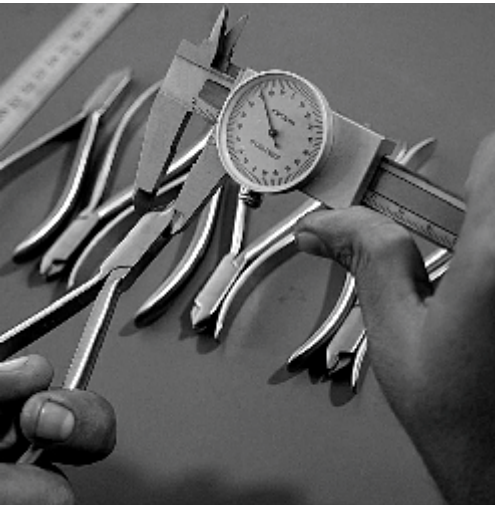
I N S T R U M E N T S



## DENTAL INSTRUMENTS CATALOGUE



Superior  
**Craftsmanship**



### **CORPORATE GOAL**

To be the market leader in manufacturing world's finest Surgical & Dental Instruments, at the most competitive prices.

Never compromise on Quality!

During the initial years of our formation, we worked hard to precisely understand the requirements of our respected customers, which has gradually improved over time. As our guiding philosophy, we put the concepts of "Customer First" and "Quality First" into practice, to respond to the expectation of our customers.

### **QUALITY ASSURANCE**

Our commitment to the quality ethics and performance of all our instruments is demonstrated by our accreditation to the International quality assurance standards of ISO 9001:2008, ISO 13485:2003, cGMP & CE.

### **GUARANTEE**

Our guarantee is your complete satisfaction.

We take great pride in our reputation for manufacturing "consistent" quality instruments as per our customer's requirements. We offer our customers a complete guarantee when it comes to the workmanship and materials of all our products.

### **R&D**

Our company take R&D as a continuing driving force for the research and development of our Instruments. Our company is well equipped with in-house R&D department, with state of the art machinery, where every piece is put through stringent tests before its final assembling. It provides us ample scope to adapt the needs of our valued clients.

### **CHILD LABOR POLICY**

As good corporate citizens and most importantly as a matter of social responsibility, we are committed to the ideas of protecting children from the exploitations of child labor. We strongly believe that the future growth of children, of their communities and the country as a whole is best served through education, not child labor.



## **REPAIR & RESTORATION**

We offers complete surgical and dental instruments repair and restoration service, utilized in all kinds of operating procedures at very competitive rates.

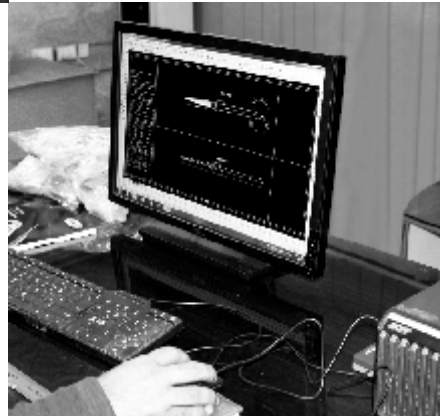
Our services include, but are not limited to, complete set restoration, instrument customization, gold plating, laser/chemical etching, coding, final finishing, Re-Polishing and most importantly the functional performance of an instrument and its aesthetic appearance.

## **OEM MANUFACTURING**

We not only manufactures fine quality surgical instruments, but we also provide complete modification and customization of instrument design according to its specific usage. All OEM instruments are carefully hand crafted with details to guarantee quality and exact specifications.

We can work pretty much on anything, from physical samples to hand drawn sketches, high precision 3D CAD models and drawings.

Our experience and knowledge in hand crafting surgical and dental instruments, combined with modern engineering capabilities, allow us to adopt the finest techniques to apply to each product, to accomplish the outcomes our customers require.



<b>02</b>	<b>Company Prole   Technical Information</b> Firmenprol   Technische Informationen Prol de l'entreprise   Information technique Perl de la empresa   Información técnica Prolo Compagnia   Informazioni tecniche	<b>191</b>	<b>Implantology</b> Implantologie Implantologie Implantología Implantologia
<b>05</b>	<b>Extracting Forceps</b> Zahnzangen Daviers Pinzas de extracción Pinze da estrazione	<b>214</b>	<b>Periosteal   Curettes   Rongeurs</b> Raspatorien   Küretten   Hohlmeißelzangen Rugines   Curettes   Pincas gouges Periostótomos   Curetas   Pinzas gubias 221 Scollaperiosteo   Curettes   Pinze ossivore
<b>44</b>	<b>Root Elevators</b> Wurzelheber Elevatori per radici Elevadores para raíces Élévateurs pour racines	<b>239</b>	<b>Dental Restoration   Periodontology</b> Restaurative Zahnheilkunde   Parodontologie Odontologie conservatrice   Parodontie Odontología conservadora   Periodoncia Odontoiatria conservativa   Parodontologia
<b>75</b>	<b>Scalpel Blades and Handles</b> Skalpellschneidmesser und Skalpellgriffe Lames et manches de bistouris Hojas y mangos de bisturí Lame e manici per bisturi	<b>304</b>	<b>Suction Tubes</b> Saugkanülen Canules d'aspiration Cánulas de aspiración 313 Cannule per aspirazione
<b>82</b>	<b>Surgical Scissors</b> Chirurgische Scheren Ciseaux chirurgicaux Tijeras quirúrgicas Forbici Chirurgiche	<b>311</b>	<b>Orthodontics</b> Kieferorthopädie Orthodontie Ortodoncia 321 Ortodonzia
<b>110</b>	<b>Tissue and Dressing Forceps</b> Chirurgische und Anatomische Pinzetten Pincas à tissu et à pansement Pinzas quirúrgicas y anatómicas Pinzette chirurgiche e anatomiche	<b>321</b>	<b>Crown Instruments   Laboratory</b> Kroneninstrumente   Labor Instruments à couronnes   laboratoire Instrumentos para coronas   laboratorio 333 Strumenti per corone   laboratorio
<b>137</b>	<b>Needle Holders</b> Nadelhalter Porte-aiguilles Porta-agujas Port'aghi	<b>334</b>	<b>Instrument Maintenance   Sterilization</b> Instrumentenwartung   Sterilisierung Entretien des instruments   Stérilisation Mantenimiento   Esterilización Manutenzione   Sterilizzazione
<b>159</b>	<b>Hemostatic Forceps   Towel Clamps</b> Arterienklemmen   Tuchklemmen Pincas hémostatiques   Fixe-compresses Pinzas hemostáticas   Pinzas de campo Pinzette emostatiche   Fissateli		
<b>170</b>	<b>Retractors   Mouth Gags</b> Retraktoren   Mundsperrer Écarteurs   Ouvre-bouche Separadores   Abrebocas Divaricatori   Apribocca		



# DENTAL Instruments

Extracting Forceps

Root Elevators

Scalpel Blades and Handles

Surgical Scissors

Tissue and Dressing Forceps

Needle Holders

Hemostatic Forceps | Towel Clamps

Retractors | Mouth Gags

Implantology

Periosteal | Curettes | Rongeurs

Dental Restoration | Periodontology

Suction Tube

Orthodontics

Crown Instruments | Laboratory

Instrument Maintenance | Sterilization



**05-43**

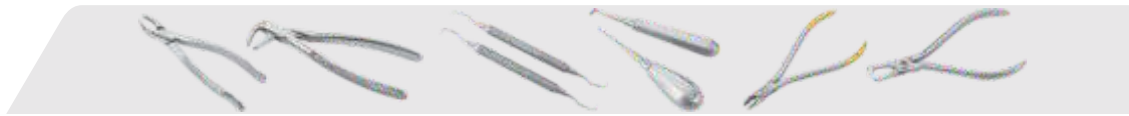
**Extracting Forceps**

Zahnzangen

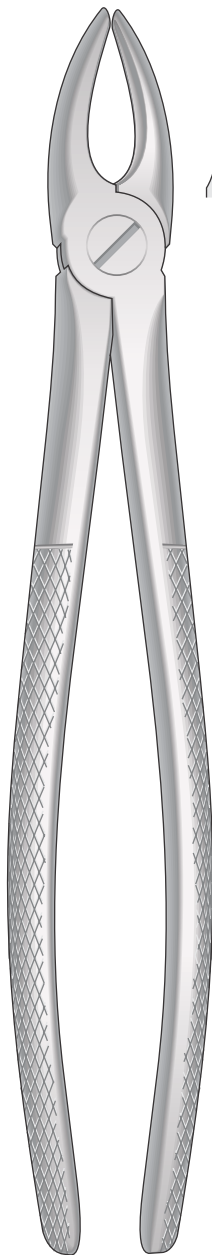
Daviers

Pinzas de extracción

Pinze da estrazione

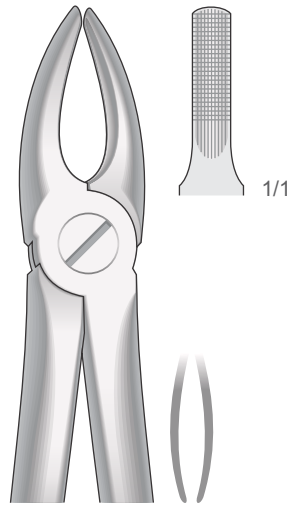


Zahnzangen, Englische Form  
Extracting Forceps, English Pattern  
Pinze per estrazione, Forma Inglese  
Pinzas da extracción, Forma Inglesa  
Daviers, Forme Anglaise



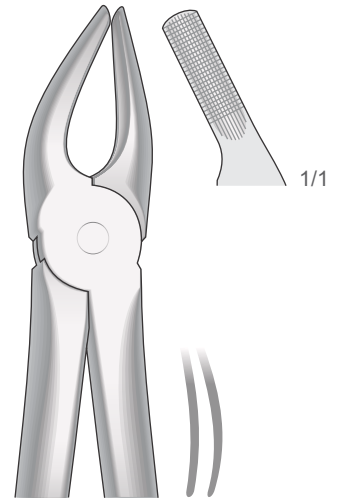
**NMI-1**  
Fig. 1

Obere Schneide- und Eckzähne  
Upper Incisors and cuspids  
Incisivi e canini superiori  
Incisivos y caninos superiores  
Incisives et canines supérieures



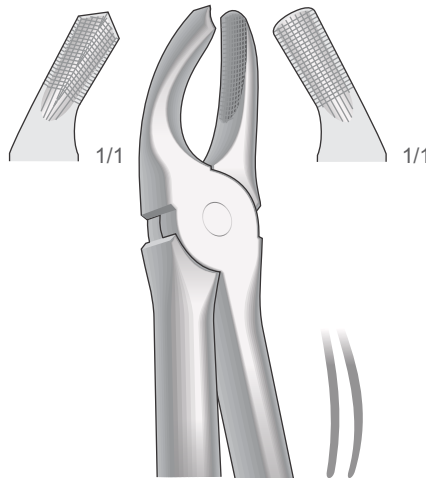
**NMI-2**  
Fig. 2

Obere Schneide- und Eckzähne  
Upper Incisors and cuspids  
Incisivi e canini superiori  
Incisivos y caninos superiores  
Incisives et canines supérieures



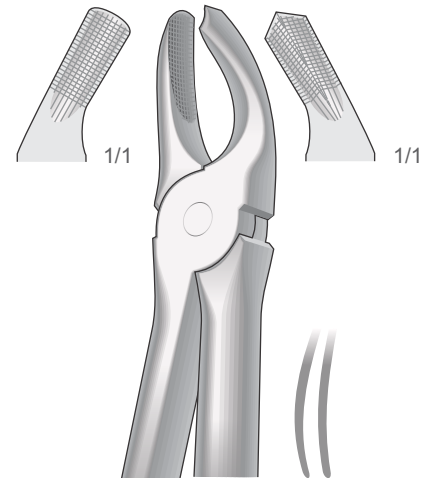
**NMI-7**  
Fig. 7

Obere Prämolaren  
Upper premolars  
Premolari superiori  
Premolares superiores  
Prémolaires supérieures



**NMI-17**  
Fig. 17

Obere Molaren, rechts  
Upper molars, right  
Molari superiori, destra  
Molares superiores, derechos  
Molaires supérieures, droites

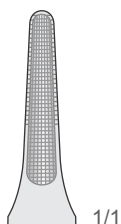
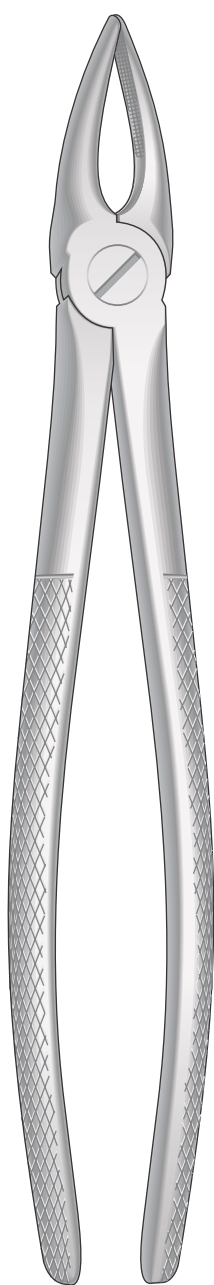


**NMI-18**  
Fig. 18

Obere Molaren, links  
Upper molars, left  
Molari superiori, sinistra  
Molares superiores, izquierdos  
Molaires supérieures, gauches



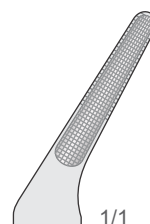
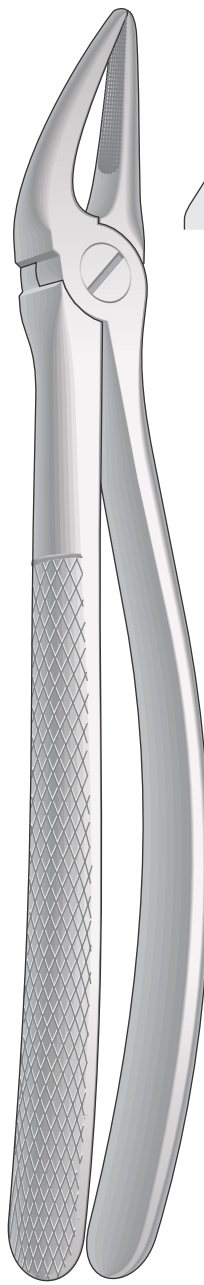
Zahnzangen, Englische Form  
Extracting Forceps, English Pattern  
Pinze per estrazione, Forma Inglese  
Pinzas da extracción, Forma Inglesa  
Daviers, Forme Anglaise



1/1

Obere Wurzeln und Schneidezähne  
Upper Roots and incisors  
Radici e incisivi superiori  
Raíces y incisivos superiores  
Racines et incisives supérieures

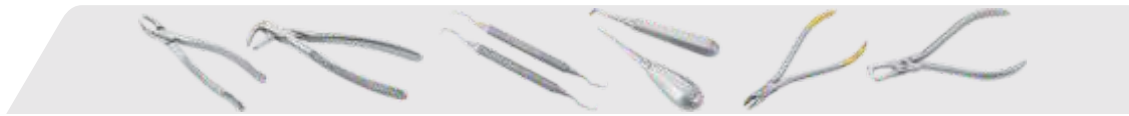
**NMI-29**  
Fig. 29



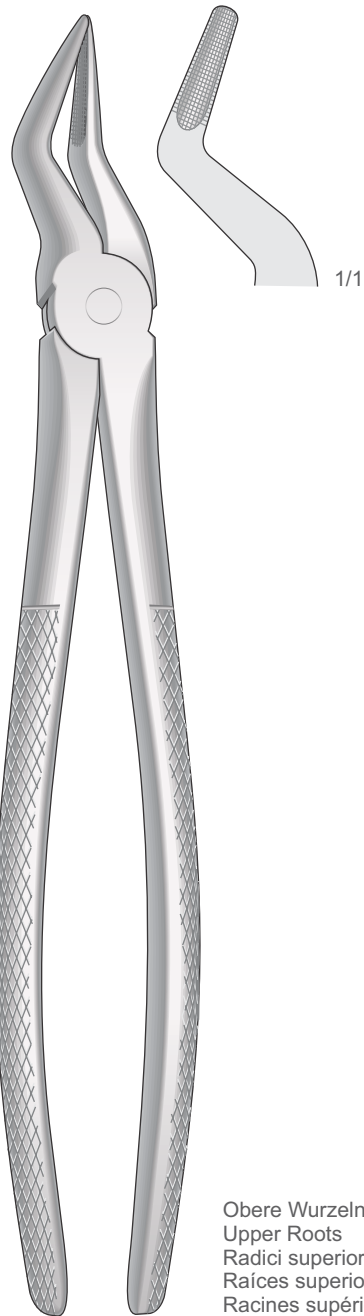
1/1

Obere Wurzeln  
Upper Roots  
Radici superiori  
Raíces superiores  
Racines supérieures

**NMI-30**  
Fig. 30

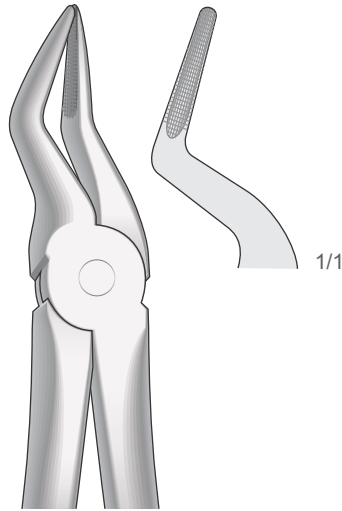


Zahnzangen, Englische Form  
Extracting Forceps, English Pattern  
Pinze per estrazione, Forma Inglese  
Pinzas da extracción, Forma Inglesa  
Daviers, Forme Anglaise



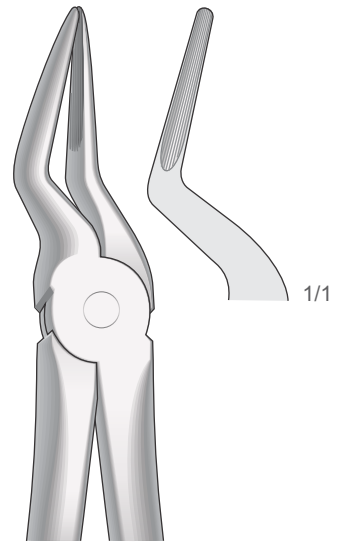
**NMI-51**  
Fig. NMI-51

Obere Wurzeln  
Upper Roots  
Radici superiori  
Raíces superiores  
Racines supérieures



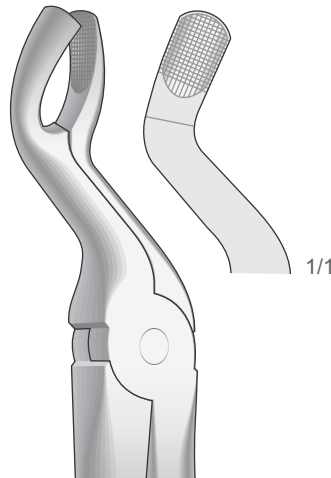
**NMI-51A**  
Fig. NMI-51A

Obere Wurzeln  
Upper Roots  
Radici superiori  
Raíces superiores  
Racines supérieures



**NMI-51L**  
Fig. NMI-51AL

Obere Wurzeln  
Upper Roots  
Radici superiori  
Raíces superiores  
Racines supérieures

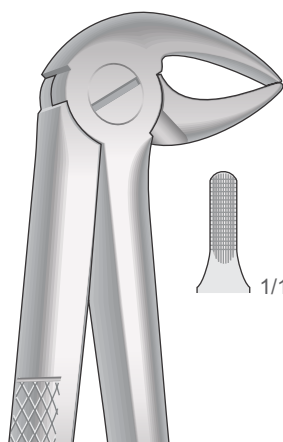


**67A**  
Fig. 67A

Obere Dritte Molaren - Für Obere Weisheitszähne  
Upper molars - For Upper wisdom teeth  
Ottavi superiori - Per denti del giudizio superiori  
Molares superiores - Para muelas del juicio superiores  
Molaires supérieures - Pour dents de sagesse supérieures

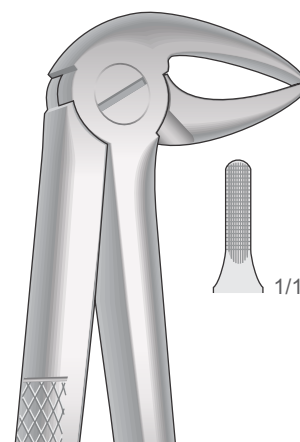


Zahnzangen, Englische Form  
Extracting Forceps, English Pattern  
Pinze per estrazione, Forma Inglese  
Pinzas da extracción, Forma Inglesa  
Daviers, Forme Anglaise



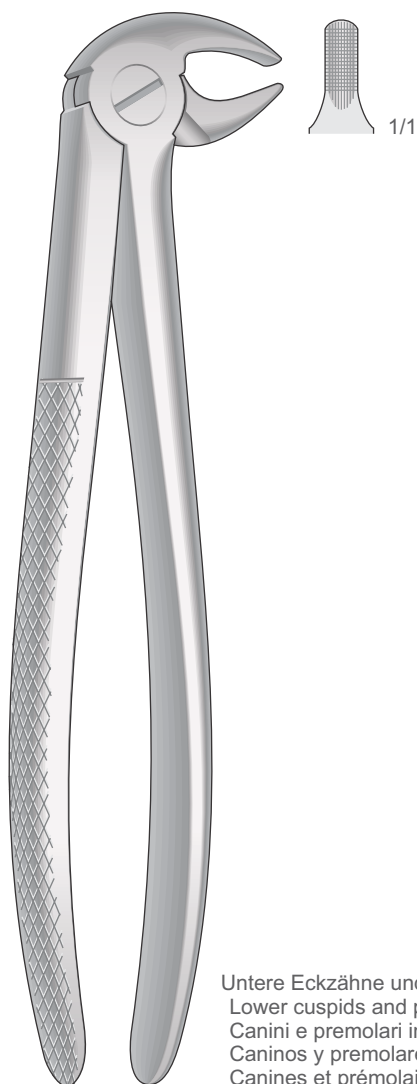
**NMI-33**  
Fig. 33

Untere Prämolaren, Schneidezähne und Wurzeln  
Lower incisors, premolars and roots  
Incisivi, premolari e radici inferiori  
Incisivos, premolares y raíces inferiores  
Incisives, prémolaires et racines inférieures



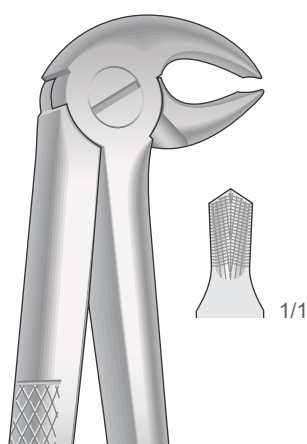
**NMI-33A**  
Fig. 33A

Untere Wurzeln, schlankes Maul  
Lower roots, Slender jaw  
Radici inferiori, morso stretto  
Raíces inferiores, boca estrecha  
Racines inférieures, avec un bec très fin



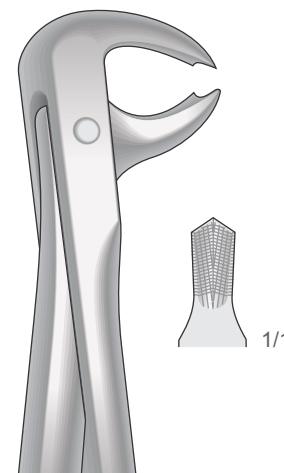
**NMI-13**

Untere Eckzähne und Prämolaren  
Lower cuspids and premolars  
Canini e premolari inferiori  
Caninos y premolares inferiores  
Canines et prémolaires inférieures



**NMI-22**  
Fig. 22

Untere Molaren  
Lower molars  
Molari inferiori  
Molares inferiores  
Molaires inférieures

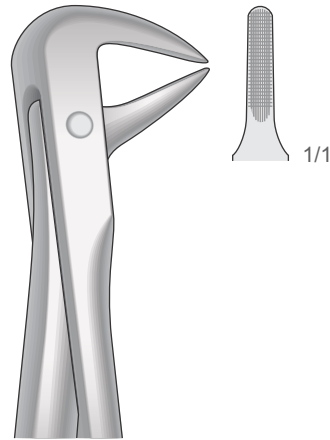


**NMI-73**  
Fig. 73

Untere Molaren  
Lower molars  
Molari inferiori  
Molares inferiores  
Molaires inférieures

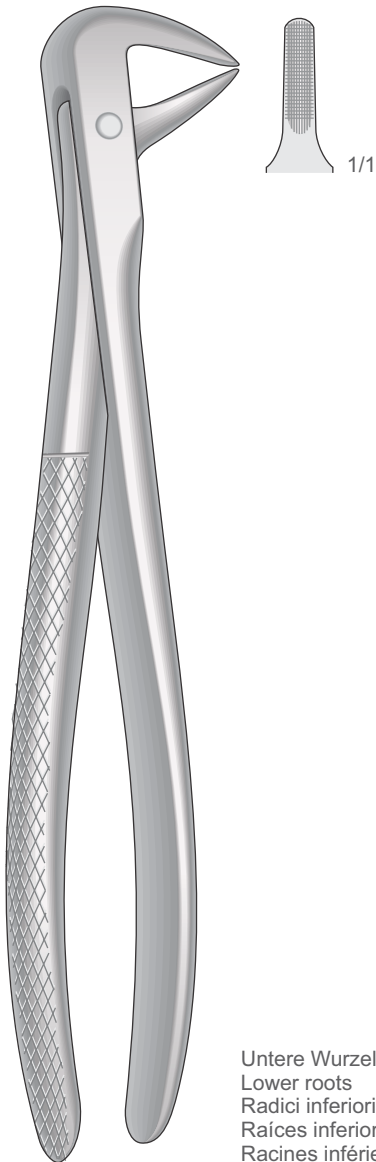


Zahnzangen, Englische Form  
Extracting Forceps, English Pattern  
Pinze per estrazione, Forma Inglese  
Pinzas da extracción, Forma Inglesa  
Daviers, Forme Anglaise



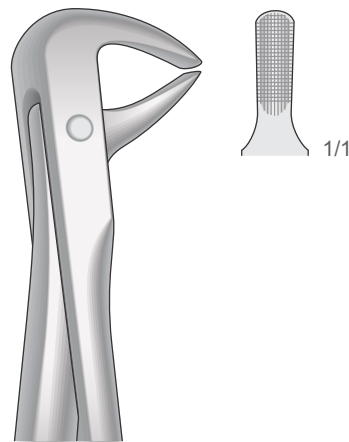
**NMI-74N**  
Fig. 74N

Untere Wurzeln, schneide-und Eckzähne  
Lower roots, Incisors and bicuspid  
Radici, incisivi e canini inferiori  
Raíces, incisivos y caninos inferiores  
Racines, incisives et canines inférieures



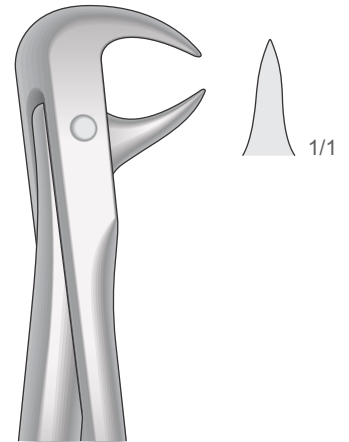
**NMI-74**  
Fig. 74

Untere Wurzeln  
Lower roots  
Radici inferiori  
Raíces inferiores  
Racines inférieures



**NMI-75**  
Fig. 75

Untere Eckzähne und Prämolaren  
Lower Cuspids and bicuspid  
Canini e premolari inferiori  
Caninos y premolares inferiores  
Canines et prémolaires inférieures

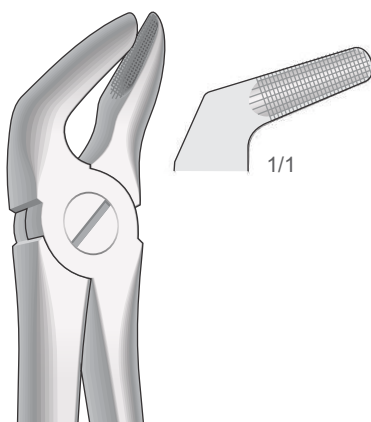


**NMI-86A**  
Fig. 86A

Untere Molaren  
Lower molars  
Molari inferiori  
Molares inferiores  
Molaires inférieures

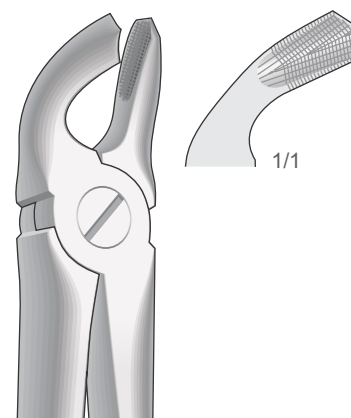


Zahnzangen, Englische Form  
Extracting Forceps, English Pattern  
Pinze per estrazione, Forma Inglese  
Pinzas da extracción, Forma Inglesa  
Daviers, Forme Anglaise



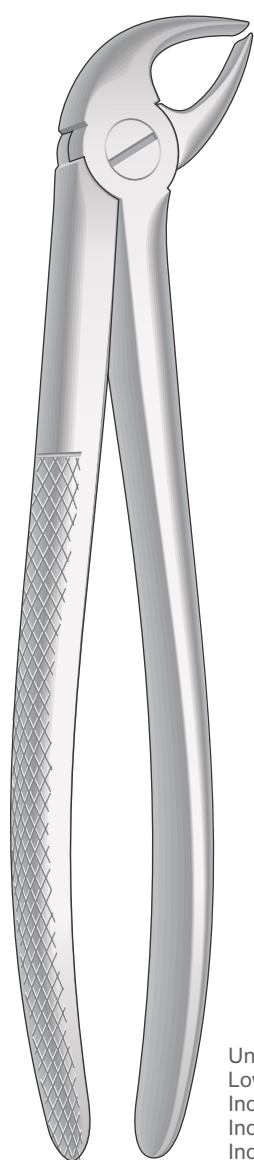
**NMI-8**  
Fig. 8

Untere Prämolaren  
Lower premolars  
Premolari inferiori  
Premolares inferiores  
Prémolaires inférieures



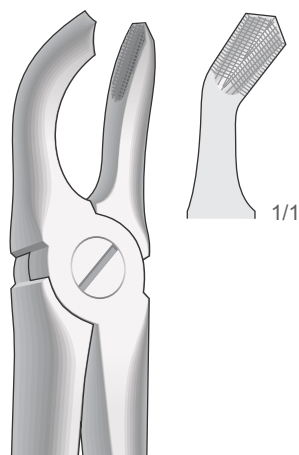
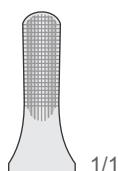
**NMI-21**  
Fig. 21

Untere Weisheitszähne und Molaren  
Lower wisdom teeth and molars  
Denti del giudizio e molari inferiori  
Muelas del juicio y Molares inferiores  
Dents de sagesse et molaires inférieures



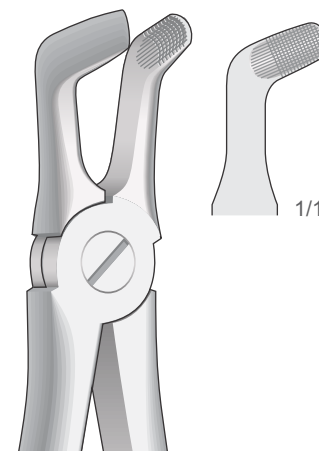
**NMI-4**  
Fig. 4

Untere Schneide- und Eckzähne  
Lower Incisors and cuspids  
Incisivi e canini inferiori  
Incisivos y caninos inferiores  
Incisives et canines inférieures



**NMI-79**  
Fig. 79

Untere Weisheitszähne  
Lower wisdom teeth  
Denti del giudizio inferiori  
Muelas del juicio inferiores  
Dent de sagesse inférieures

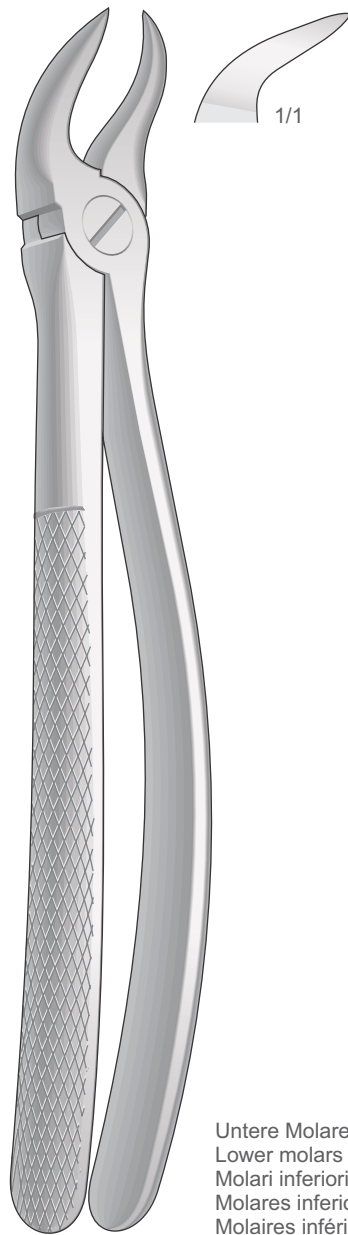


**NMI-79A**  
Fig. 79A

Untere Molaren und Weisheitszähne  
Lower molars and wisdom teeth  
Molari e denti del giudizio inferiori  
Molares y muelas del juicio inferiores  
Molaires et dent de sagesse inférieures

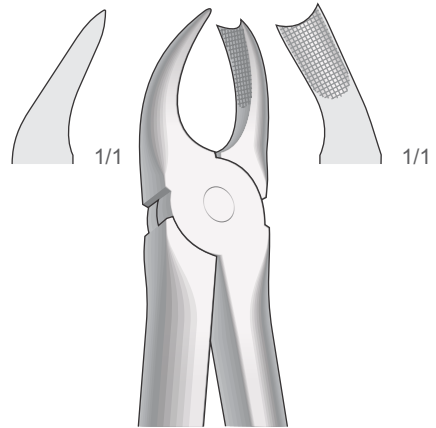


Zahnzangen, Englische Form  
Extracting Forceps, English Pattern  
Pinze per estrazione, Forma Inglese  
Pinzas da extracción, Forma Inglesa  
Daviers, Forme Anglaise



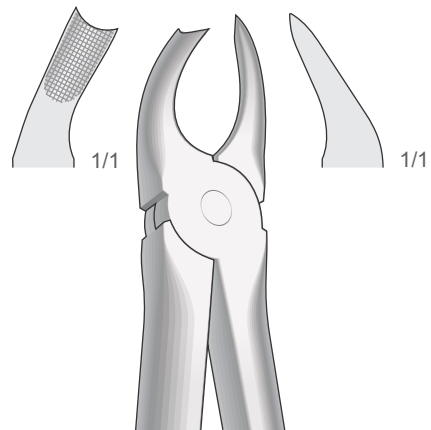
**NMI-87**  
Fig. 87

Untere Molaren  
Lower molars  
Molari inferiori  
Molares inferiores  
Molaires inférieures



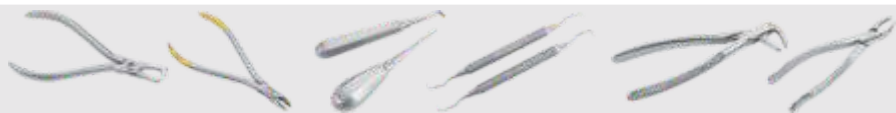
**NMI-89**  
Fig. 89

Obere Molaren, rechts  
Upper molars, right  
Molari superiori, destra  
Molares superiores, derechos  
Molaires supérieures, droites

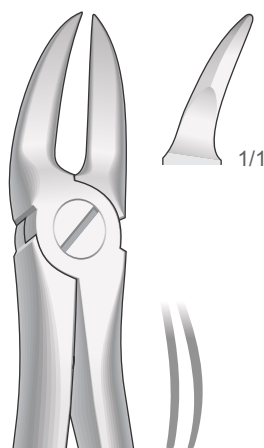


**NMI-90**  
Fig. 90

Obere Molaren, links  
Upper molars, left  
Molari superiori, sinistra  
Molares superiores, izquierdos  
Molaires supérieures, gauches

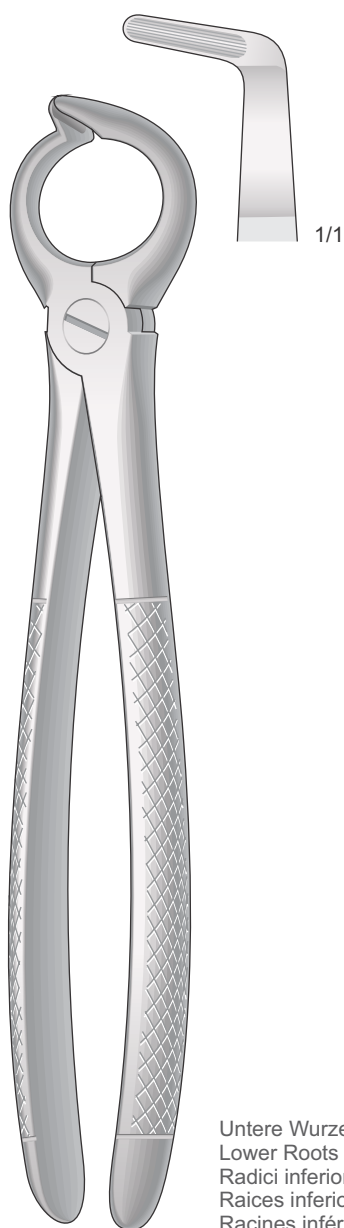


Zahnzangen, Englische Form  
Extracting Forceps, English Pattern  
Pinze per estrazione, Forma Inglese  
Pinzas da extracción, Forma Inglesa  
Daviers, Forme Anglaise



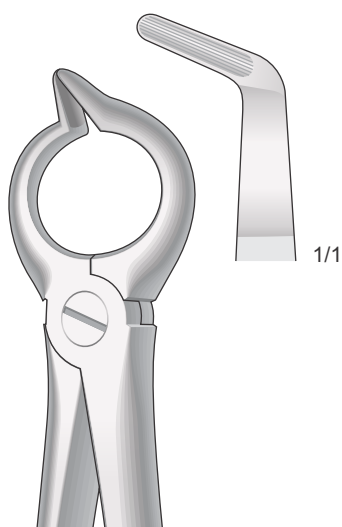
**NMI-55**  
Fig. 55

Zum Trennen oberer Molarenwurzeln  
For separating upper molar roots  
Per radici dei molari superiori, presa in profondità  
Para partir raíces de molares superiores, profundo  
Pour séparer les racines des molaires supérieures



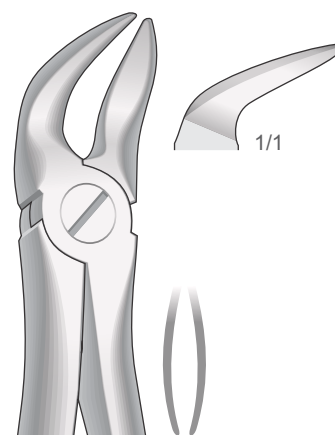
**NMI-68**  
Fig. 68

Untere Wurzeln  
Lower Roots  
Radici inferiori  
Raíces inferiores  
Racines inférieures



**NMI-68A**  
Fig. 68A

Untere Wurzeln  
Lower Roots  
Radici inferiori  
Raíces inferiores  
Racines inférieures

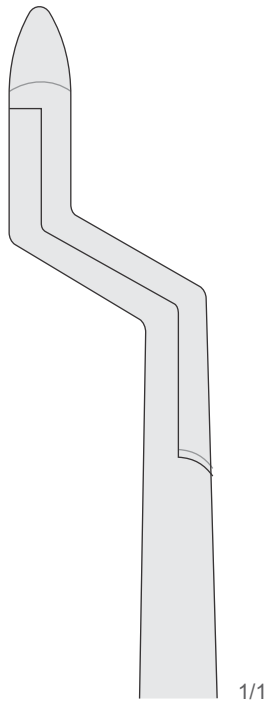
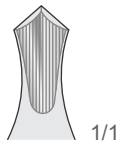
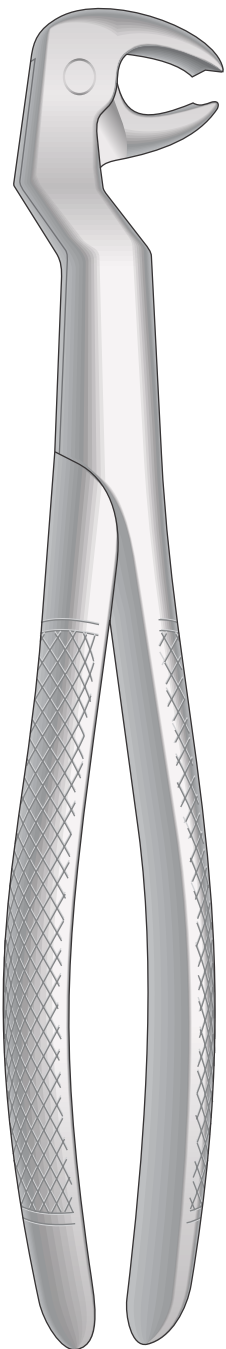


**NMI-56**  
Fig. 56

Zum Trennen Unterer Molarenwurzeln  
For separating lower molar roots  
Per radici dei molari inferiori, presa in profondità  
Para partir raíces de molares inferiores, profundo  
Pour séparer les racines des molaires inférieures

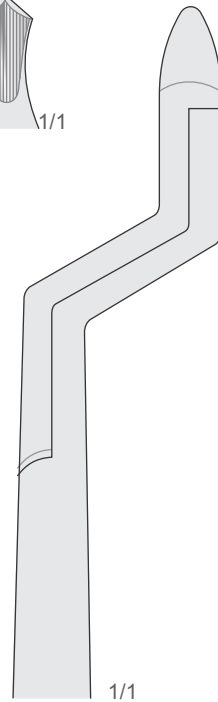
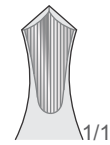
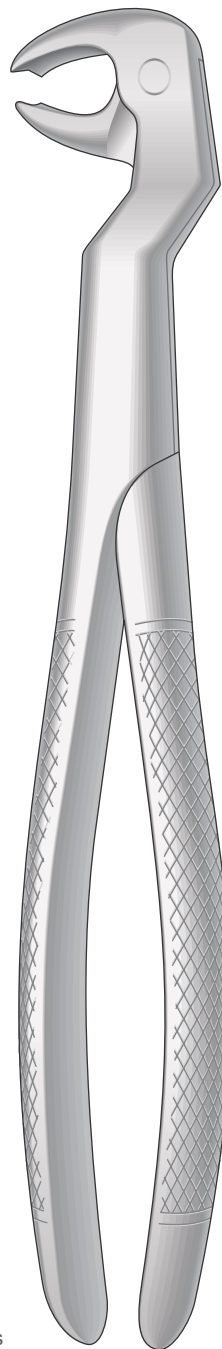


Zahnzangen, Englische Form  
Extracting Forceps, English Pattern  
Pinze per estrazione, Forma Inglese  
Pinzas da extracción, Forma Inglesa  
Daviers, Forme Anglaise



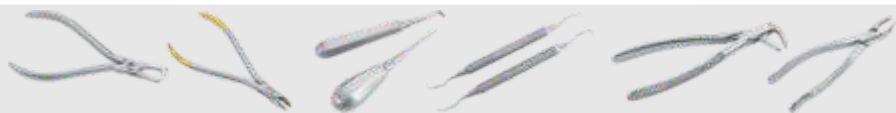
Untere Molaren und Weisheitszähne, rechts  
Lower molars and wisdom teeth, right  
Molari e denti del giudizio inferiori, a destra  
Molares y muelas del juicio inferiores, derecha  
Molaires et dent de sagesse inférieures, droites

**ROUTURIER**  
**NMI-22 1/2 R**

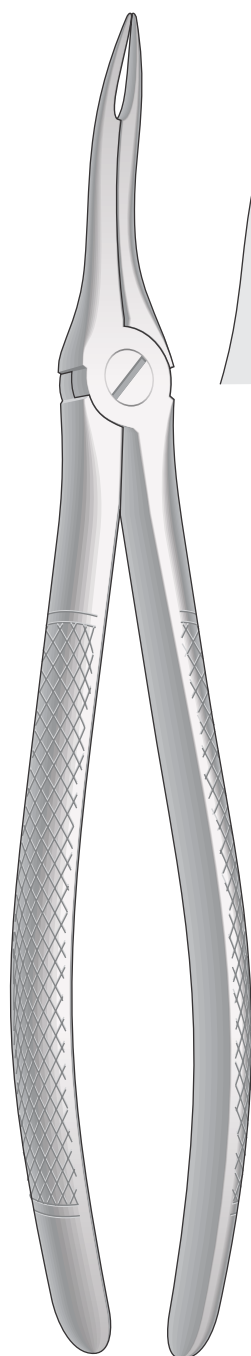


Untere Molaren und Weisheitszähne, links  
Lower molars and wisdom teeth, left  
Molari e denti del giudizio inferiori, a sinistra  
Molares y muelas del juicio inferiores, izquierda  
Molaires et dent de sagesse inférieures, gauches

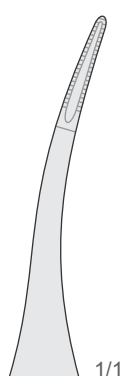
**ROUTURIER**  
**NMI-22 1/2 L**



Zahnzangen, Englische Form  
Extracting Forceps, English Pattern  
Pinze per estrazione, Forma Inglese  
Pinzas da extracción, Forma Inglesa  
Daviers, Forme Anglaise



**NMI-49**  
Fig. 49



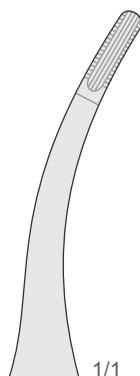
1/1

Obere Wurzeln sehr feine  
Upper very fine roots  
Radici superiori molto sottili  
Raíces superiores muy finas  
Racines supérieures très fines

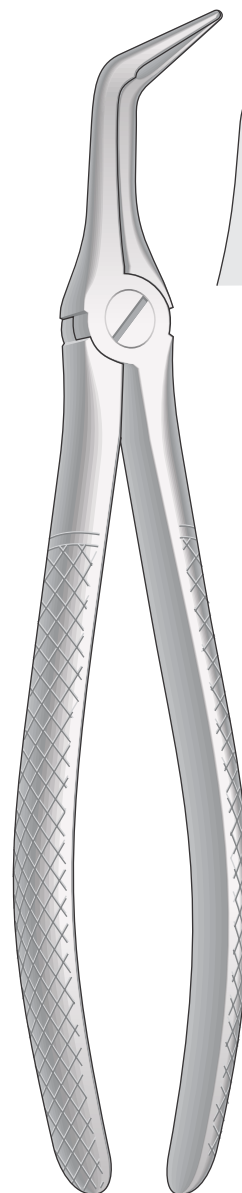


**NMI-48**  
Fig. 48 - 44

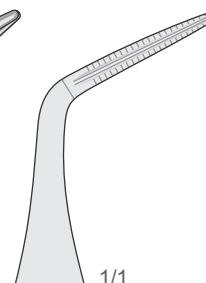
Obere Wurzeln  
Upper roots  
Radici superiori  
Raíces superiores  
Racines supérieures



1/1



**NMI-46L**  
Fig. 46L

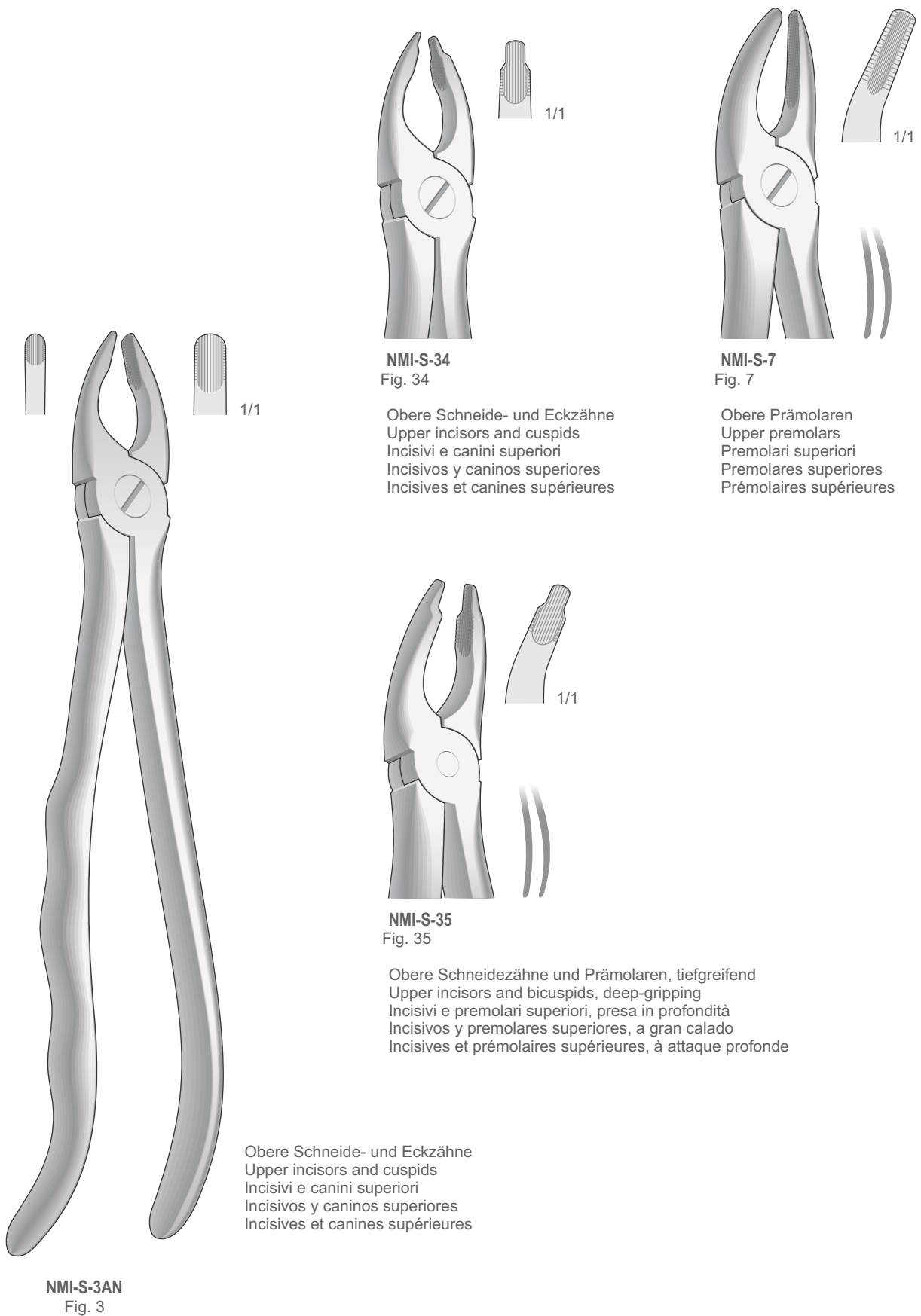


1/1

Untere Wurzeln  
Lower roots  
Radici inferiori  
Raíces inferiores  
Racines inférieures



Zahnzangen, Paßformgriff  
Extracting Forceps, Anatomical Handle  
Pinze per estrazione, Manico anatomico  
Pinzas da extracción, Mango anatómico  
Daviers, Manche anatomique



**NMI-S-34**  
Fig. 34  
Obere Schneide- und Eckzähne  
Upper incisors and cuspids  
Incisivi e canini superiori  
Incisivos y caninos superiores  
Incisives et canines supérieures

**NMI-S-7**  
Fig. 7  
Obere Prämolaren  
Upper premolars  
Premolari superiori  
Premolares superiores  
Prémolaires supérieures

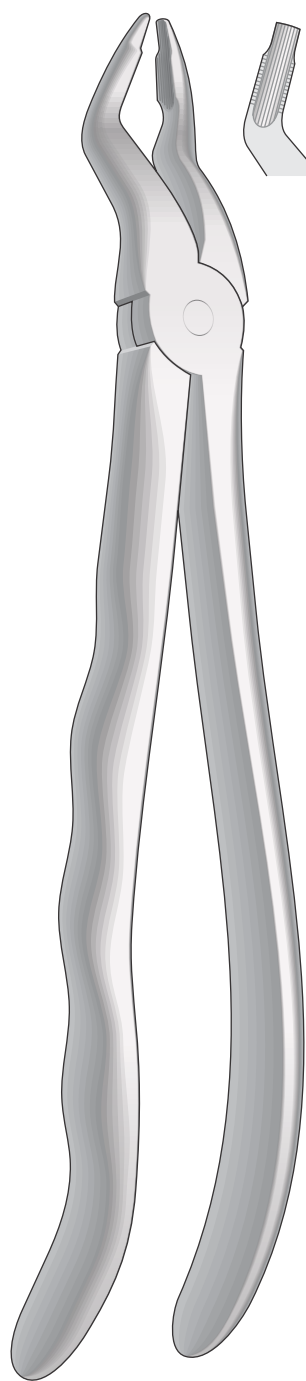
**NMI-S-35**  
Fig. 35  
Obere Schneidezähne und Prämolaren, tiefgreifend  
Upper incisors and bicuspid, deep-gripping  
Incisivi e premolari superiori, presa in profondità  
Incisivos y premolares superiores, a gran calado  
Incisives et prémolaires supérieures, à attaque profonde

Obere Schneide- und Eckzähne  
Upper incisors and cuspids  
Incisivi e canini superiori  
Incisivos y caninos superiores  
Incisives et canines supérieures

**NMI-S-3AN**  
Fig. 3

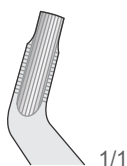


Zahnzangen, Paßformgriff  
Extracting Forceps, Anatomical Handle  
Pinze per estrazione, Manico anatomico  
Pinzas da extracción, Mango anatómico  
Daviers, Manche anatomique

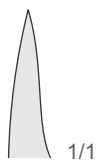


**NMI-S-31**  
Fig. 31

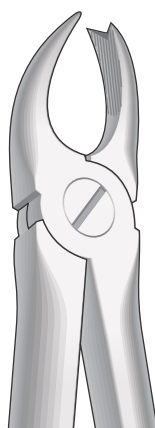
Obere Prämolaren  
Upper premolars  
Premolari superiori  
Premolares superiores  
Prémolaires supérieures



1/1

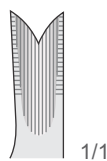


1/1

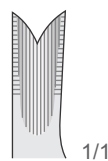


**NMI-S-66R**  
Fig. 66R (89)

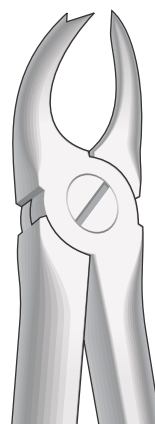
Obere Molaren, rechts  
Upper molars, right  
Molari superiori, destra  
Molares superiores, derechos  
Molaires supérieures, droites



1/1

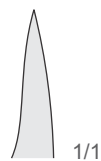


1/1

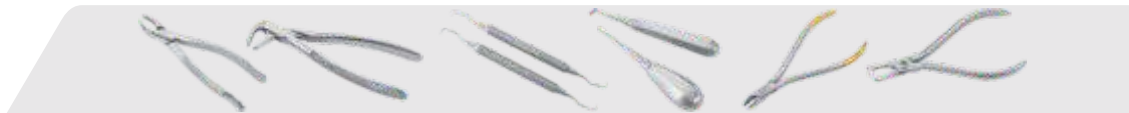


**NMI-S-66L**  
Fig. 66L

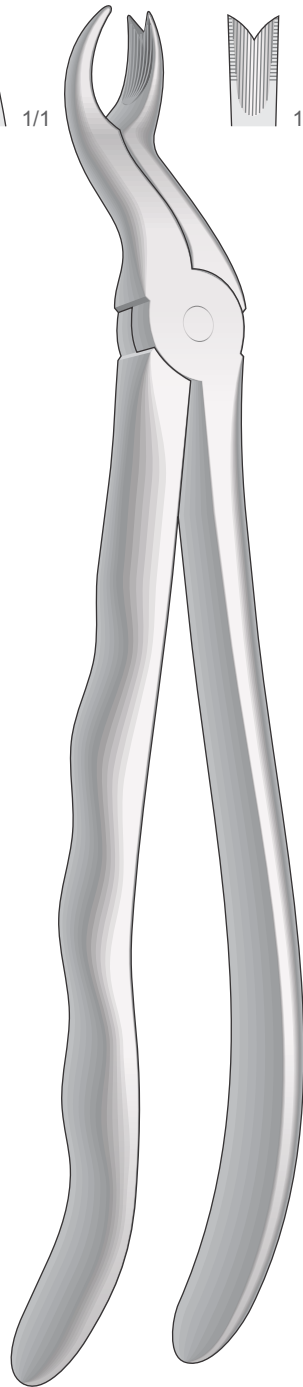
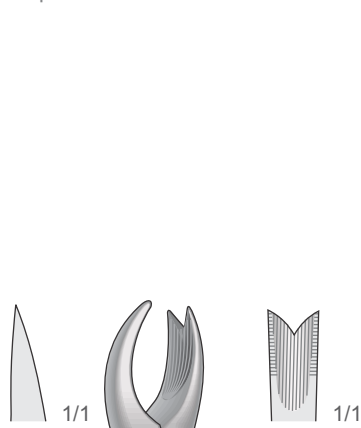
Obere Molaren, links  
Upper molars, left  
Molari superiori, sinistra  
Molares superiores, izquierdos  
Molaires supérieures, gauches



1/1

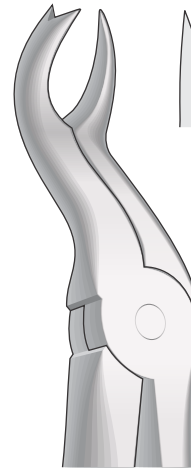
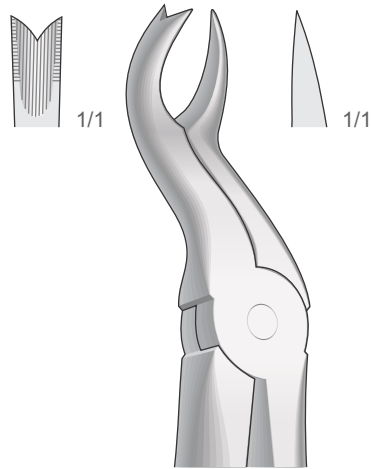


Zahnzangen, Paßformgriff  
Extracting Forceps, Anatomical Handle  
Pinze per estrazione, Manico anatomico  
Pinzas da extracción, Mango anatómico  
Daviers, Manche anatomique



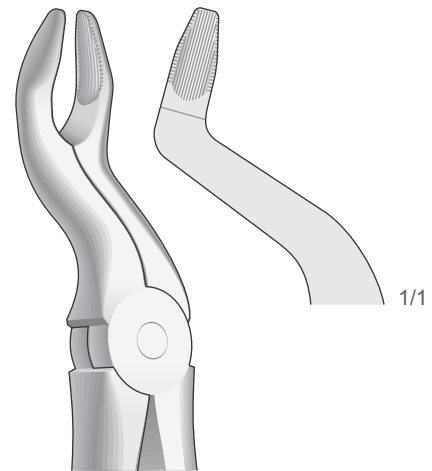
**NMI-S-67R**  
Fig. 67R

Obere Molaren, rechts  
Upper molars, right  
Molari superiori, destra  
Molares superiores, derechos  
Molaires supérieures, droites



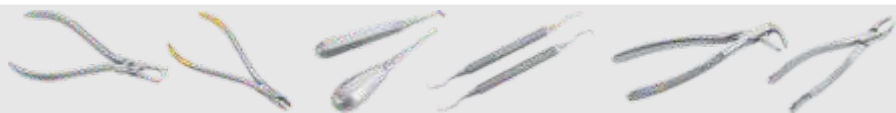
**NMI-S-67L**  
Fig. 67L

Obere Molaren, links  
Upper molars, left  
Molari superiori, sinistra  
Molares superiores, izquierdos  
Molaires supérieures, gauches

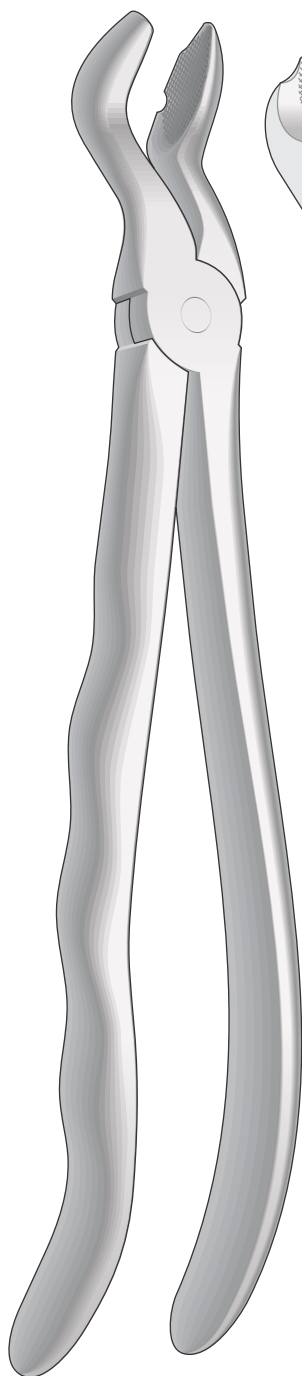


**NMI-S-67N**  
Fig. 67N

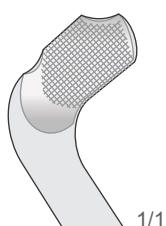
Obere Molaren  
Upper molars  
Molari superiori  
Molares superiores  
Molaires supérieures



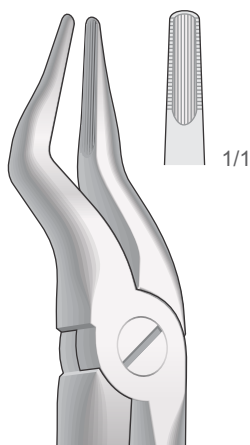
Zahnzangen, Paßformgriff  
Extracting Forceps, Anatomical Handle  
Pinze per estrazione, Manico anatomico  
Pinzas da extracción, Mango anatómico  
Daviers, Manche anatomique



FELSCH  
NMI-S-80  
Fig. 80



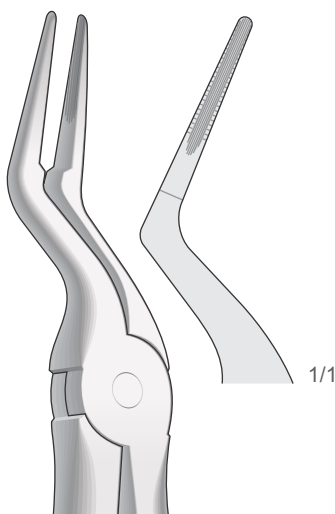
1/1



1/1

**NMI-S-51B**  
Fig. NMI-51B

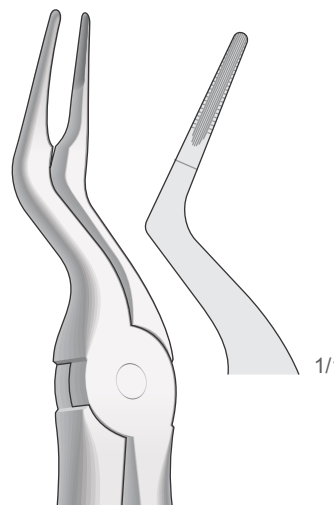
Obere Dritte Molaren  
Upper molars  
Ottavi superiori  
Molares superiores  
Molaires supérieures



1/1

**NMI-S-97**  
Fig. 97

Obere Wurzelplitterzange  
Upper Root Fragments  
Frammenti e radici superiori  
Fragmentos de raíces superiores  
Fragments des racines supérieures



1/1

**NMI-S-97B**  
Fig. 97B

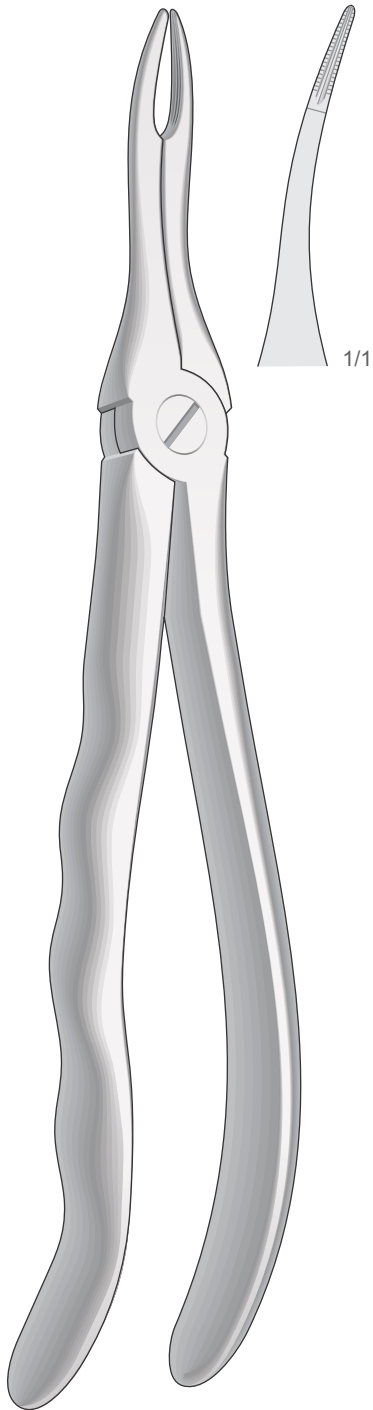
Obere Wurzelplitterzange  
Upper Root Fragments  
Frammenti e radici superiori  
Fragmentos de raíces superiores  
Fragments des racines supérieures

Für obere Weisheitszähne, mit Fangvorrichtung  
For upper wisdom teeth, with retaining device  
Denti del giudizio superiori, con dispositivo di presa  
Muelas del juicio superiores, con dispositivo de retencion  
Pour dents de sagesse supérieures, mors conçus pour recueillir la dent

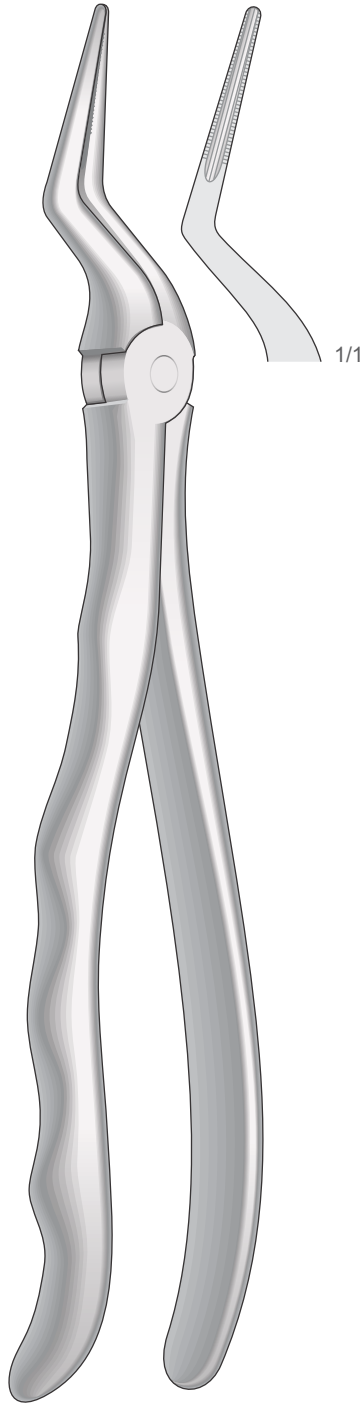


Zahnzangen, Paßformgriff  
Extracting Forceps, Anatomical Handle  
Pinze per estrazione, Manico anatomico  
Pinzas da extracción, Mango anatómico  
Daviers, Manche anatomique

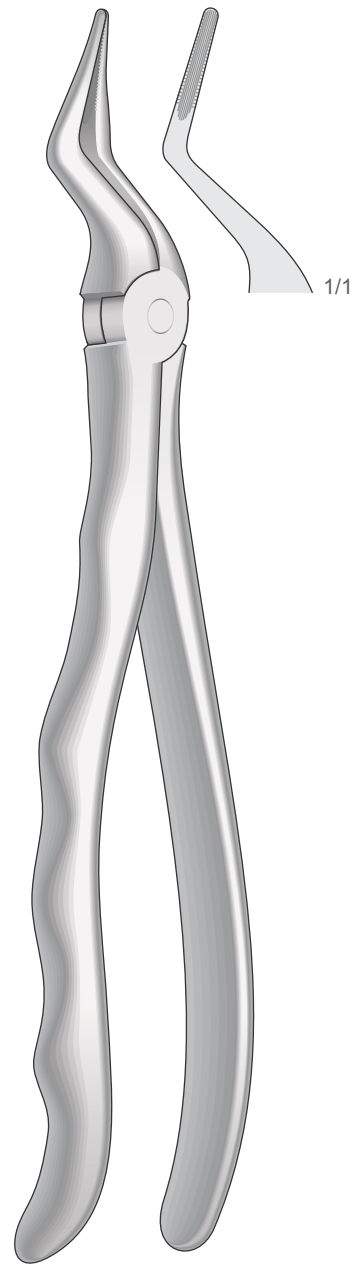
Obere Wurzeln sehr feine  
Upper very fine roots  
Radici superiori molto sottili  
Raíces superiores muy finas  
Racines supérieures très fines



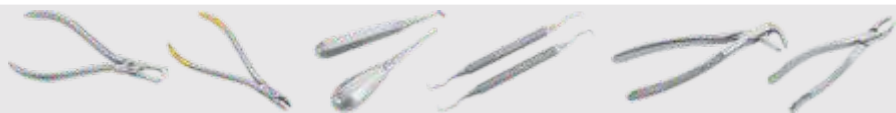
**NMI-S-49**  
Fig. 49



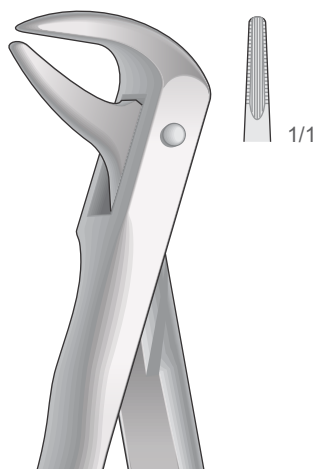
**NMI-S-51LX**  
Fig. 51LX



**NMI-S-351S**  
Fig. 351S

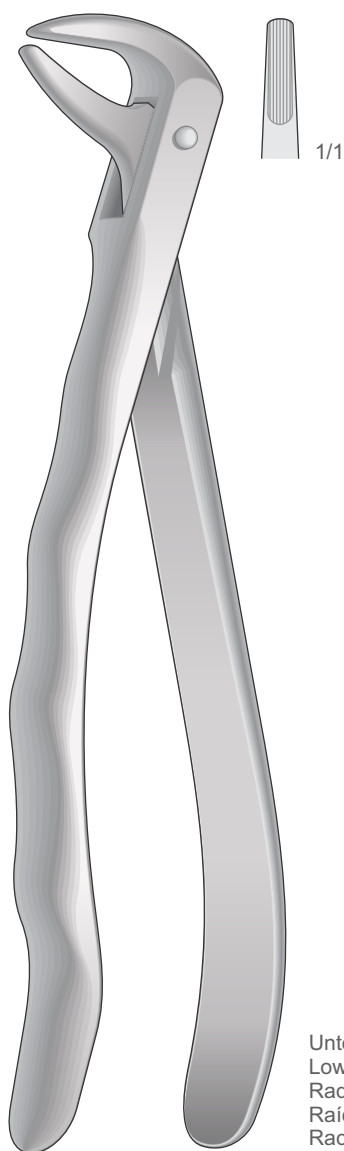


Zahnzangen, Paßformgriff  
Extracting Forceps, Anatomical Handle  
Pinze per estrazione, Manico anatomico  
Pinzas da extracción, Mango anatómico  
Daviers, Manche anatomique

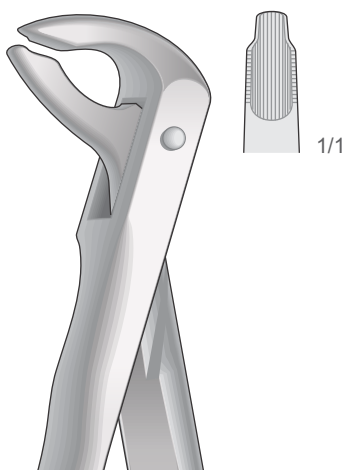


**NMI-I-74N**  
Fig. 74N

Untere Wurzeln Schneide- und Eckzähne  
Lower roots, incisors and cuspids  
Radici, incisivi e canini inferiori  
Raíces, incisivos y caninos inferiores  
Racines, incisives et canines inférieures

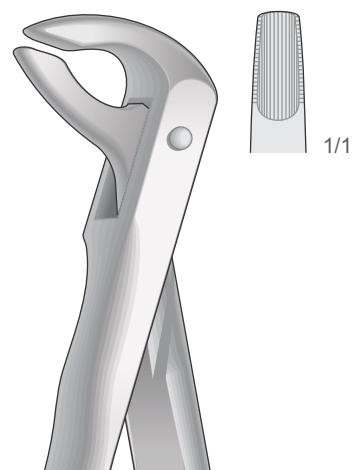


**NMI-I-74**  
Fig. 74



**NMI-I-36**  
Fig. 36

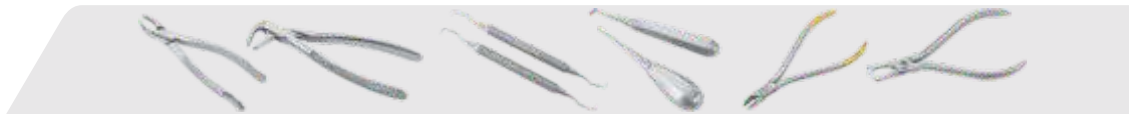
Untere Wurzeln Schneide- und Eckzähne  
Lower roots, incisors and cuspids  
Radici, incisivi e canini inferiori  
Raíces, incisivos y caninos inferiores  
Racines, incisives et canines inférieures



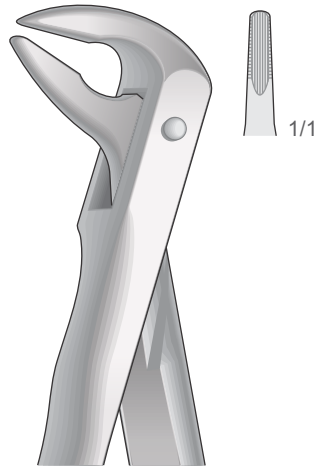
**NMI-I-36N**  
Fig. 36N

Untere Wurzeln Schneide- und Eckzähne  
Lower roots, incisors and cuspids  
Radici, incisivi e canini inferiori  
Raíces, incisivos y caninos inferiores  
Racines, incisives et canines inférieures

Untere Wurzeln Schneide- und Eckzähne  
Lower roots, incisors and cuspids  
Radici, incisivi e canini inferiori  
Raíces, incisivos y caninos inferiores  
Racines, incisives et canines inférieures

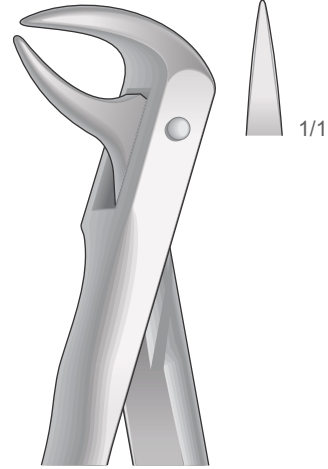


Zahnzangen, Paßformgriff  
Extracting Forceps, Anatomical Handle  
Pinze per estrazione, Manico anatomico  
Pinzas da extracción, Mango anatómico  
Daviers, Manche anatomique



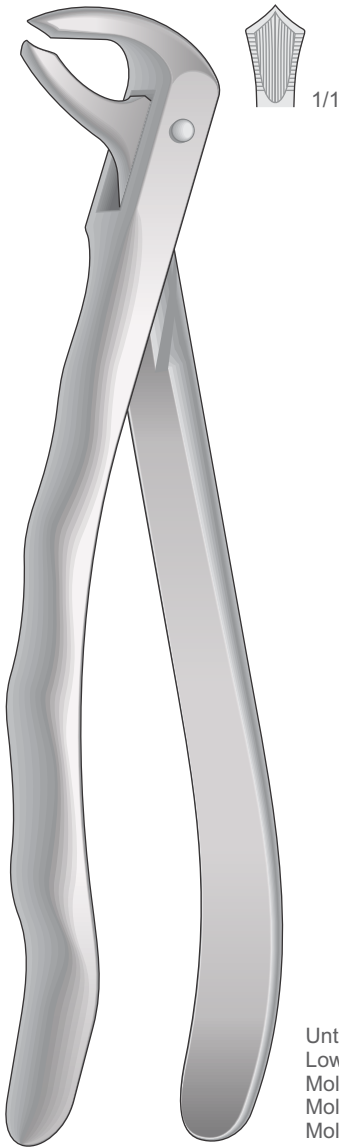
**NMI-I-59**  
Fig. 59

Untere Wurzelflitterzange  
Lower Root Fragments  
Frammenti e radici inferiori  
Fragmentos de raíces inferiores  
Fragments des racines inférieures



**NMI-I-86C**  
Fig. 86C

Untere Molaren mit kariesen oder abgebrochenen Kronen  
Lower molars with carious or broken caps  
Molari inferiori con corone cariate o spezzate  
Molares inferiores con coronas rotas o cariadas  
Molaires inférieures avec couronnes cariées ou cassées



**NMI-I-73**  
Fig. 73

Untere Molaren  
Lower molars  
Molari inferiori  
Molares inferiores  
Molaires inférieures



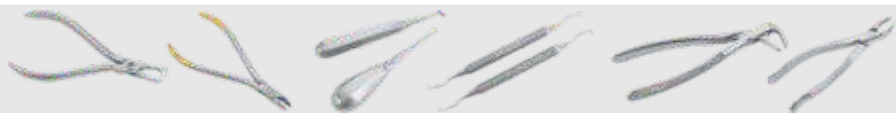
**NMI-I-13**  
Fig. 13

Untere Prämolaren und Eckzähne  
Lower premolars and cuspids  
Canini e premolari inferiori  
Caninos y premolares inferiores  
Canines et prémolaires inférieures



**NMI-I-22**  
Fig. 22

Untere Molaren  
Lower molars  
Molari inferiori  
Molares inferiores  
Molaires inférieures



Zahnzangen, Paßformgriff  
Extracting Forceps, Anatomical Handle  
Pinze per estrazione, Manico anatomico  
Pinzas da extracción, Mango anatómico  
Daviers, Manche anatomique

Untere Weisheitszähne  
Lower wisdom teeth  
Denti del giudizio inferiori  
Muelas del juicio inferiores  
Dent de sagesse inférieures

Untere Prämolaren  
Lower premolars  
Premolari inferiori  
Premolares inferiores  
Prémolaires inférieures

Untere Molaren  
Lower Molars  
Molari inferiori  
Molares inferiores  
Molaires inférieures



**NMI-I-79**  
Fig. 79

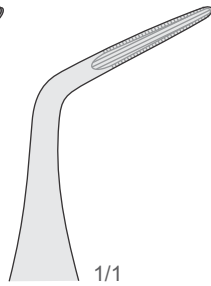
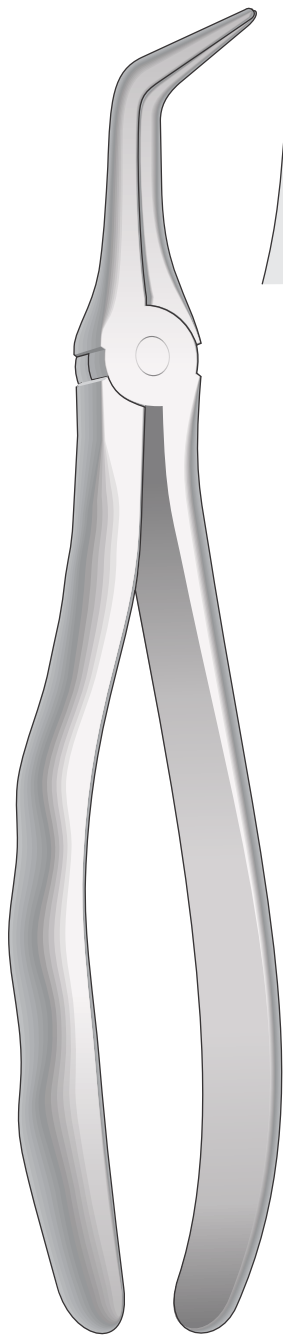
**NMI-I-79N**  
Fig. 79N

**NMI-I-46N**  
Fig. 46N

**NMI-I-87**  
Fig. 87



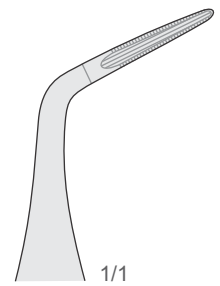
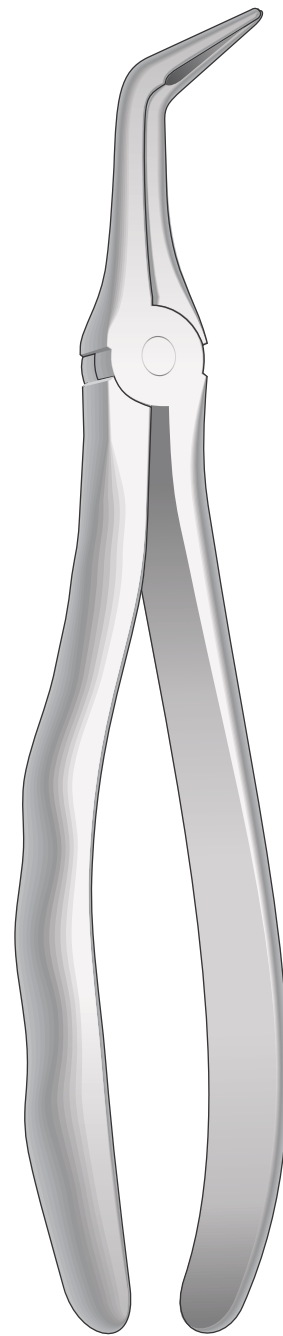
Zahnzangen, Paßformgriff  
Extracting Forceps, Anatomical Handle  
Pinze per estrazione, Manico anatomico  
Pinzas da extracción, Mango anatómico  
Daviers, Manche anatomique



1/1

Untere Wurzeln  
Lower roots  
Radici inferiori  
Raíces inferiores  
Racines inférieures

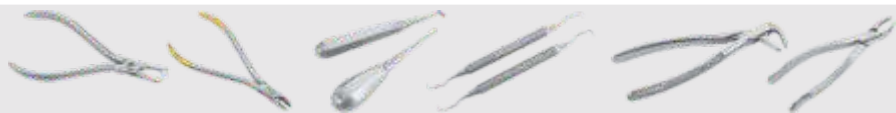
**NMI-I-46LX**  
Fig. 46LX



1/1

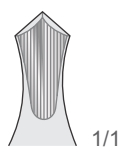
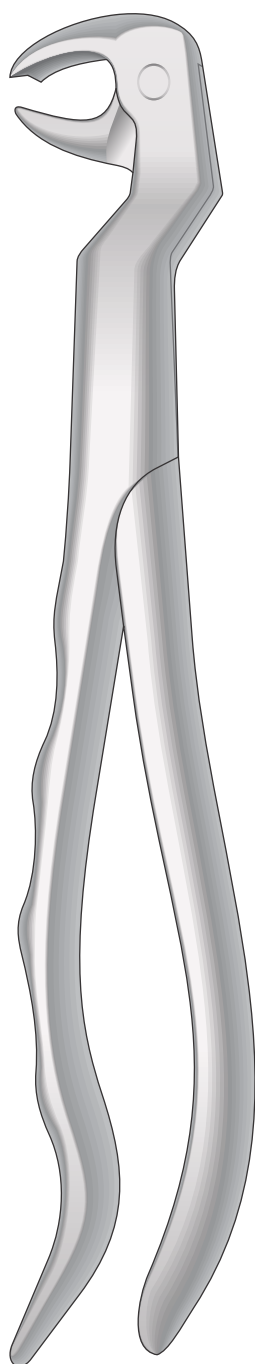
Untere Wurzeln  
Lower roots  
Radici inferiori  
Raíces inferiores  
Racines inférieures

**NMI-I-46L**  
Fig. 46L

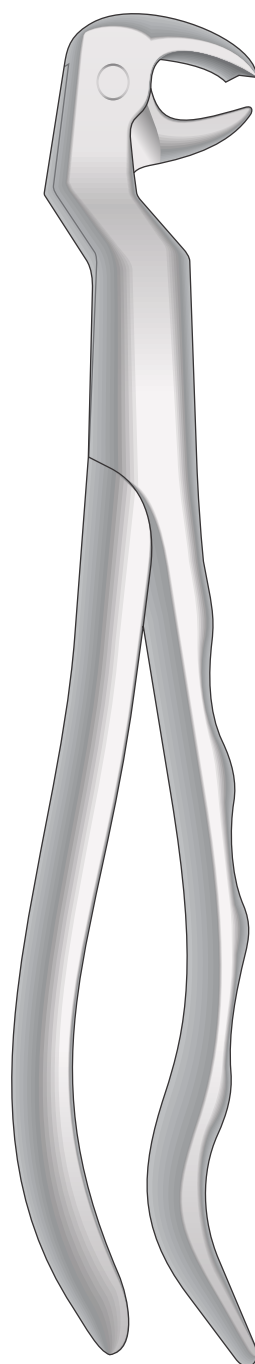


Zahnzangen, Paßformgriff  
Extracting Forceps, Anatomical Handle  
Pinze per estrazione, Manico anatomico  
Pinzas da extracción, Mango anatómico  
Daviers, Manche anatomique

Untere Molaren und Weisheitszähne  
Lower molars and wisdom teeth  
Molari e denti del giudizio inferiori  
Molares y muelas del juicio inferiores  
Molaires et dent de sagesse inférieures



1/1



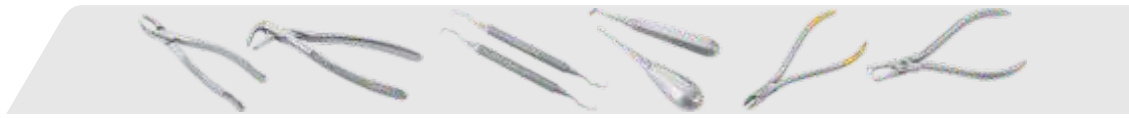
1/1

Links  
Left  
Sinistra  
Izquierdos  
Gauches

Rechts  
Right  
Destra  
Derechos  
Droites

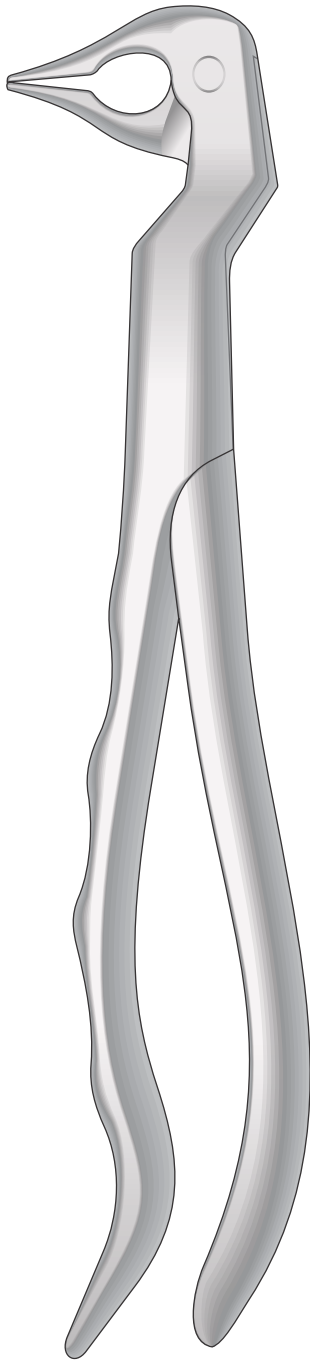
NMI-I-22 1/2 L

NMI-I-22 1/2 R



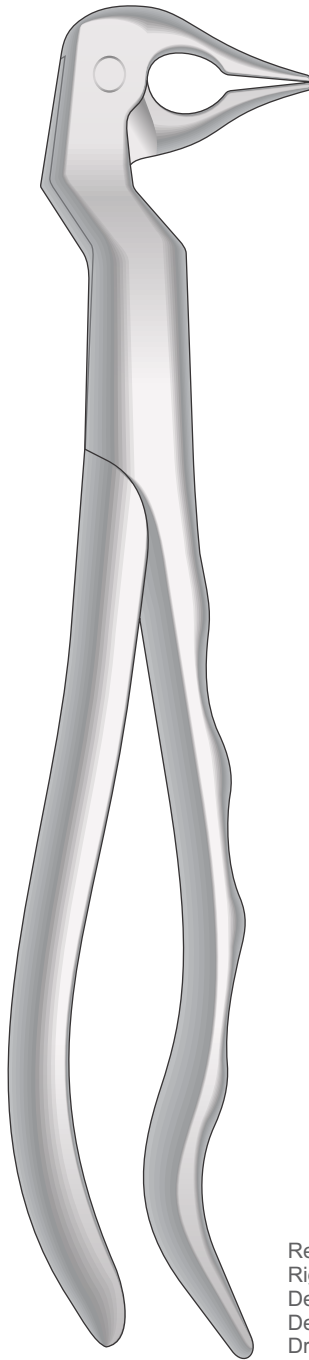
Zahnzangen, Paßformgriff  
Extracting Forceps, Anatomical Handle  
Pinze per estrazione, Manico anatomico  
Pinzas da extracción, Mango anatómico  
Daviers, Manche anatomique

Untere Wurzeln sehr feine  
Lower very fine roots  
Radici inferiori molto sottili  
Raíces inferiores muy finas  
Racines inférieures très fines



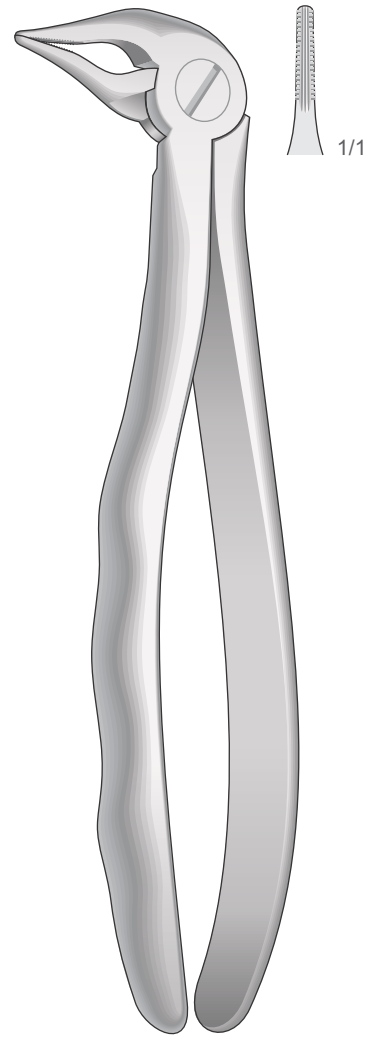
**NMI-I-133 L**  
Fig.133

Links  
Left  
Sinistra  
Izquierdos  
Gauches



**NMI-I-133 R**  
Fig.133

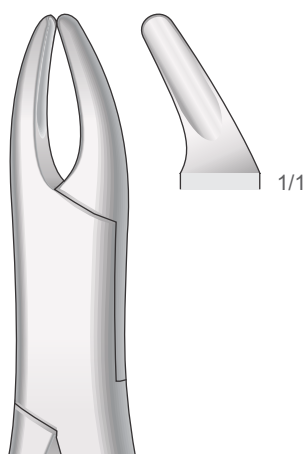
Rechts  
Right  
Destra  
Derechos  
Droites



**NMI-I-333S**  
Fig.333S

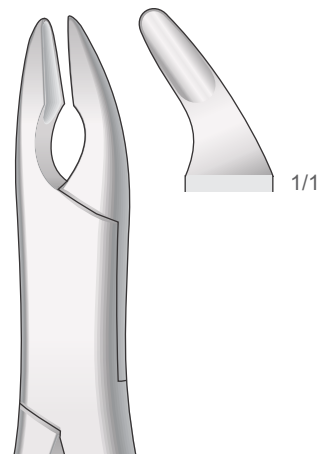


Zahnzangen, Amerikanische Form  
Extracting Forceps, American Pattern  
Pinze per estrazione, Forma Americana  
Pinzas da extracción, Forma Americana  
Daviers, Forme Américaine



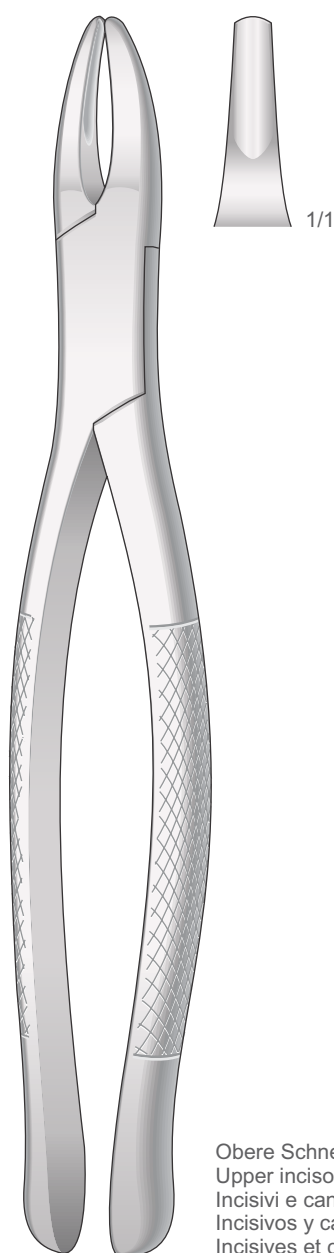
**CRYER**  
**NMI-AM-150**  
Fig. 150

Obere Prämolaren, Schneidezähne, Wurzeln  
Upper Bicuspids, incisors and roots  
Premolari, incisivi e radici superiori  
Premolares, incisivos y raíces superiores  
Prémolaires, incisives et racines supérieures



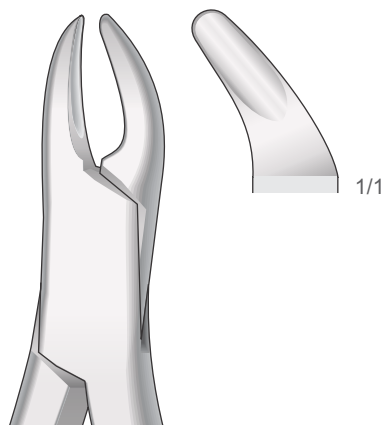
**CRYER**  
**NMI-AM-150A**  
Fig. 150A

Obere Prämolaren, Schneidezähne, Wurzeln  
Upper Bicuspids, incisors and roots  
Premolari, incisivi e radici superiori  
Premolares, incisivos y raíces superiores  
Prémolaires, incisives et racines supérieures



**NMI-AM-1**  
Fig. 1

Obere Schneide- und Eckzähne  
Upper incisors and cuspids  
Incisivi e canini superiori  
Incisivos y caninos superiores  
Incisives et canines supérieures



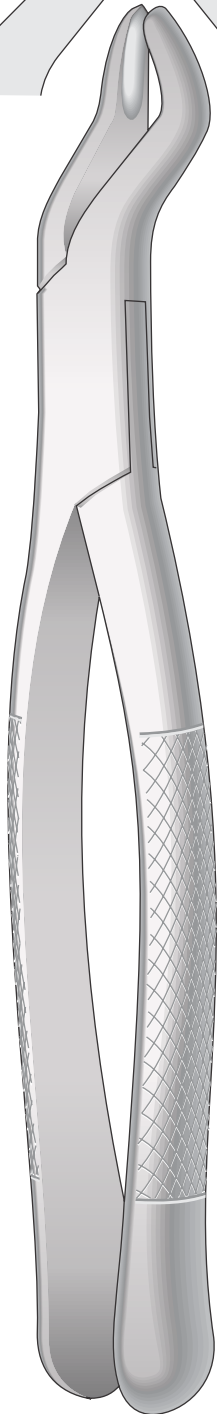
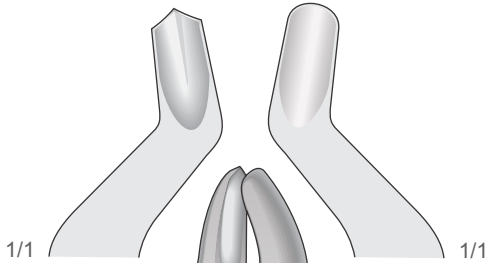
**NMI-AM-62**  
Fig. 62

Schneidezähne, Prämolaren, Milchzähne  
Incisors, premolars, deciduous teeth  
Incisivi, premolari, denti da latte  
Incisivos, premolares, dientes de leche  
Incisives, prémolaires, dents de lait

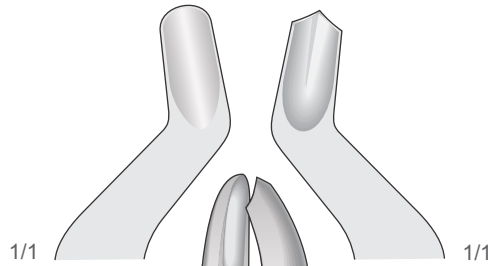




Zahnzangen, Amerikanische Form  
Extracting Forceps, American Pattern  
Pinze per estrazione, Forma Americana  
Pinzas da extracción, Forma Americana  
Daviers, Forme Américaine

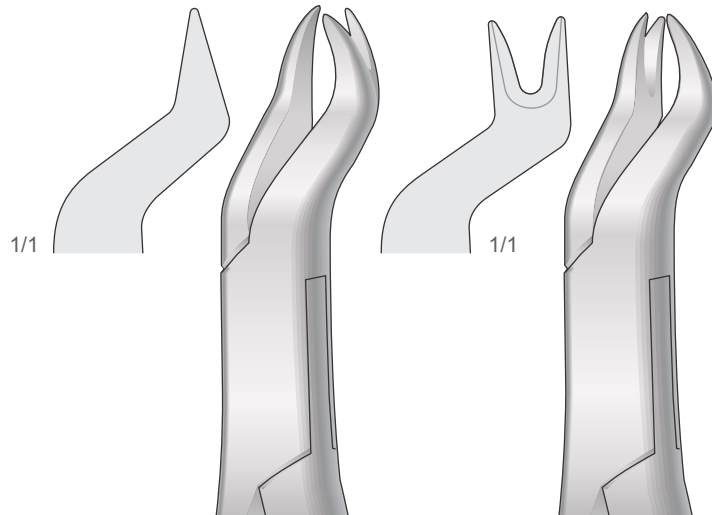


**NMI-AM-53R**  
Fig. 53R



**NMI-AM-53L**  
Fig. 53L

Obere Molaren, Links  
Upper Molars, Left  
Molari superiori, Sinistra  
Molares superiores, Izquierdos  
Molaires supérieures, Gauches

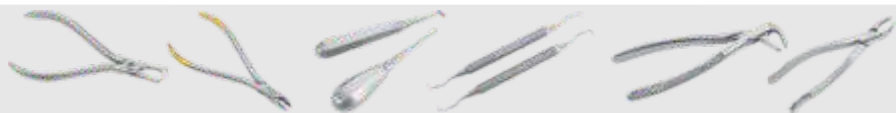


**NEVIUS  
NMI-AM-88R**  
Fig. 88R

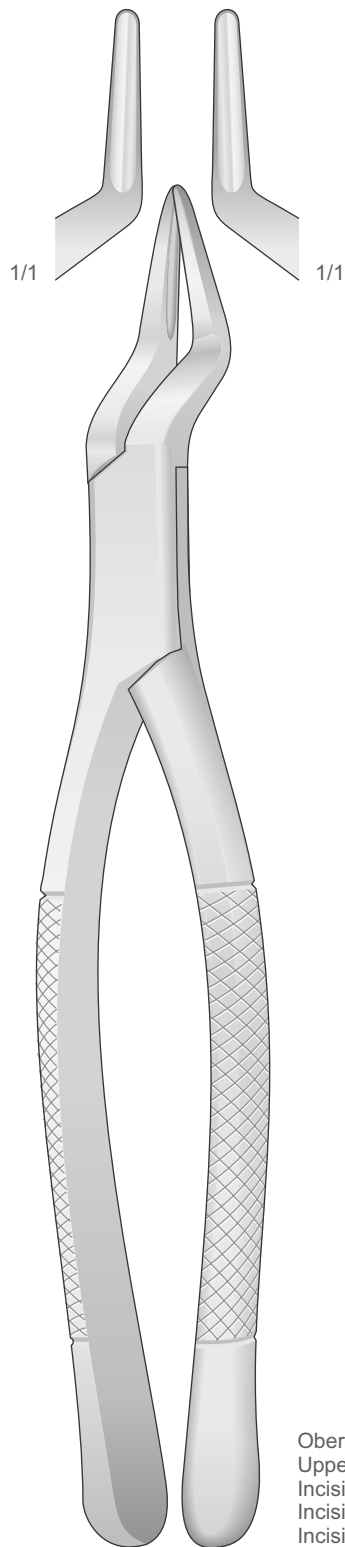
Obere Molaren, Rechts  
Upper Molars, Right  
Molari superiori, Destra  
Molares superiores, Derechos  
Molaires supérieures, Droites

**NEVIUS  
NMI-AM-88L**  
Fig. 88L

Obere Molaren, Links  
Upper Molars, Left  
Molari superiori, Sinistra  
Molares superiores, Izquierdos  
Molaires supérieures, Gauches

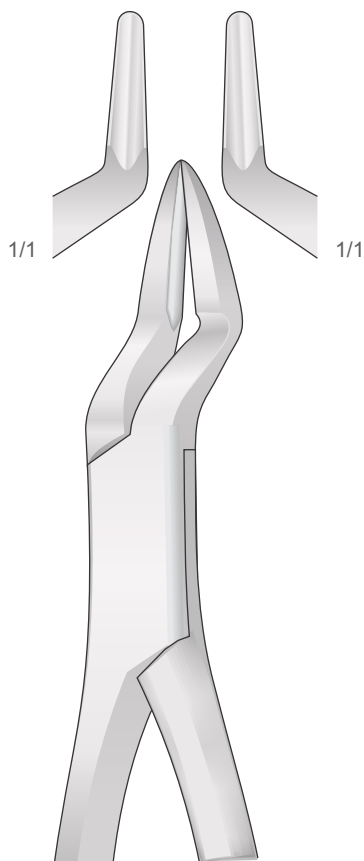


Zahnzangen, Amerikanische Form  
Extracting Forceps, American Pattern  
Pinze per estrazione, Forma Americana  
Pinzas da extracción, Forma Americana  
Daviers, Forme Américaine



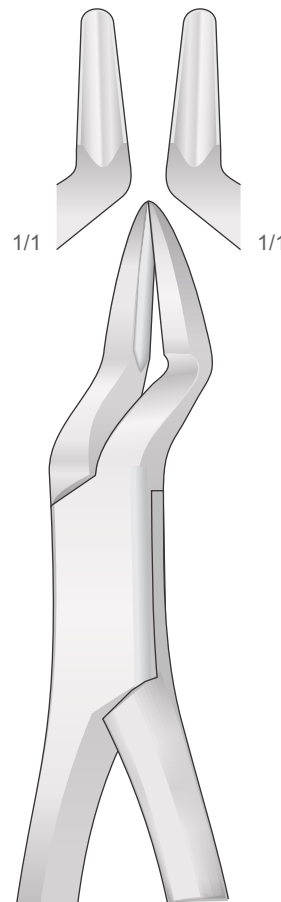
**NMI-AM-65**  
Fig.65

Obere Schneidezähne und Wurzeln  
Upper Incisors and Roots  
Incisivi e radici superiori  
Incisivos y raíces superiores  
Incisives et racines supérieures



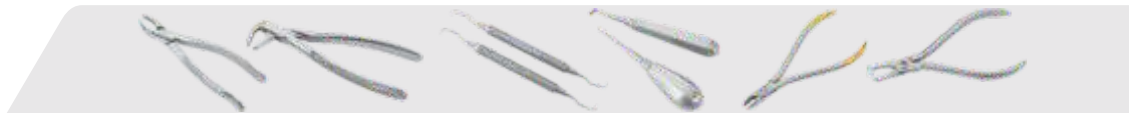
**PARMLY**  
**NMI-AM-32A**  
Fig. 32A

Obere Wurzeln und Prämolaren  
Upper Roots and Premolars  
Radici e premolari superiori  
Raíces y premolares superiores  
Racines et prémolaires supérieures

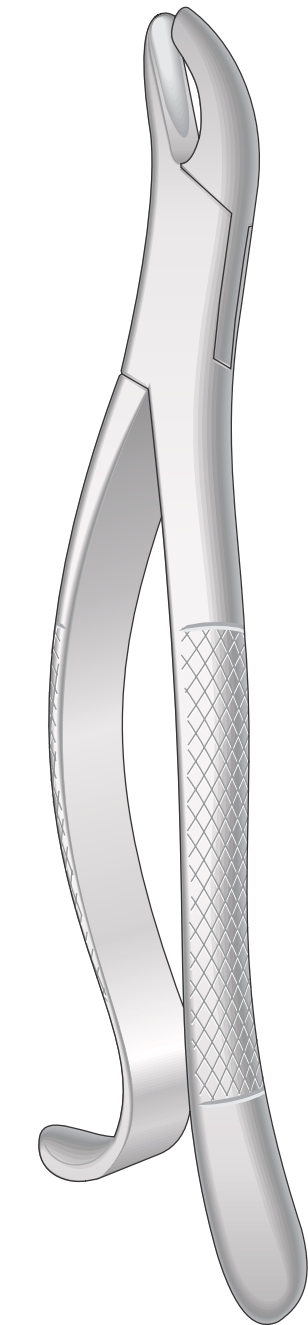
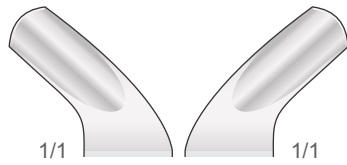


**PARMLY**  
**NMI-AM-32**  
Fig. 32

Obere Prämolaren und Molaren  
Upper Premolars and Molars  
Premolari e molari superiori  
Premolares y Molares superiores  
Prémolaires et Molaires supérieures

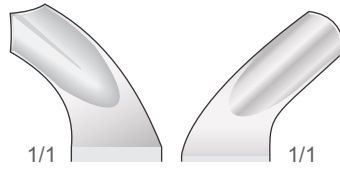


Zahnzangen, Amerikanische Form  
Extracting Forceps, American Pattern  
Pinze per estrazione, Forma Americana  
Pinzas da extracción, Forma Americana  
Daviers, Forme Américaine



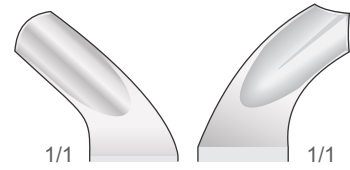
**NMI-AM-24**  
Fig. 24

Obere Molaren  
Upper Molars  
Molari superiori  
Molares superiores  
Molaires supérieures



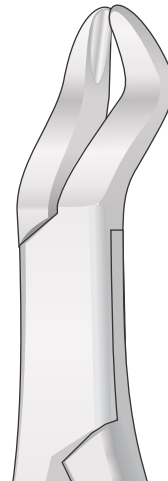
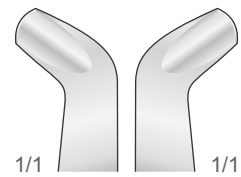
**HARRIS**  
**NMI-AM-18R**  
Fig. 18R

Obere Molaren, Rechts  
Upper Molars, Right  
Molari superiori, Destra  
Molares superiores, Derechos  
Molaires supérieures, Droites



**HARRIS**  
**NMI-AM-18L**  
Fig. 18L

Obere Molaren, Links  
Upper Molars, Left  
Molari superiori, Sinistra  
Molares superiores, Isquierdos  
Molaires supérieures, Gauches

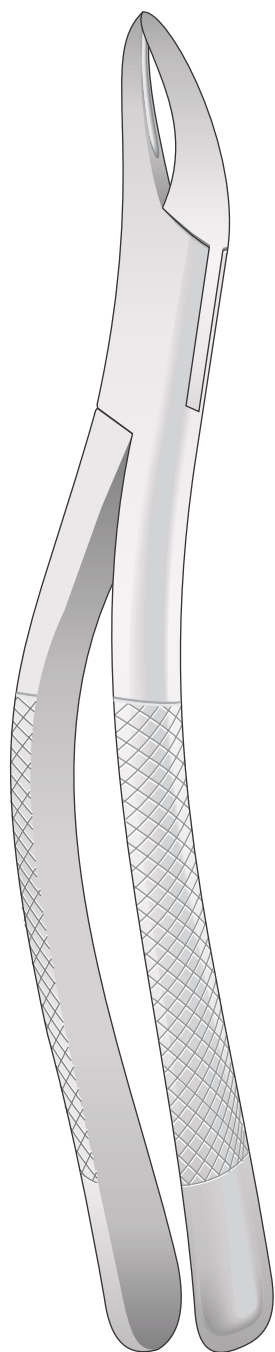
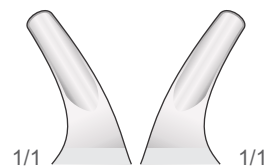
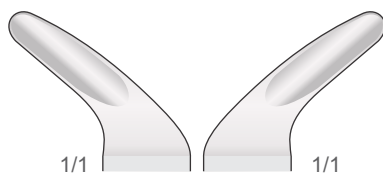
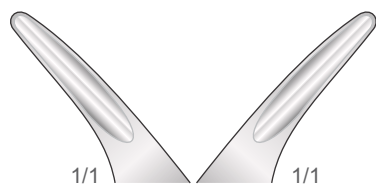


**NMI-AM-210**  
Fig. 210

Obere Molaren  
Upper Molars  
Molari superiori  
Molares superiores  
Molaires supérieures



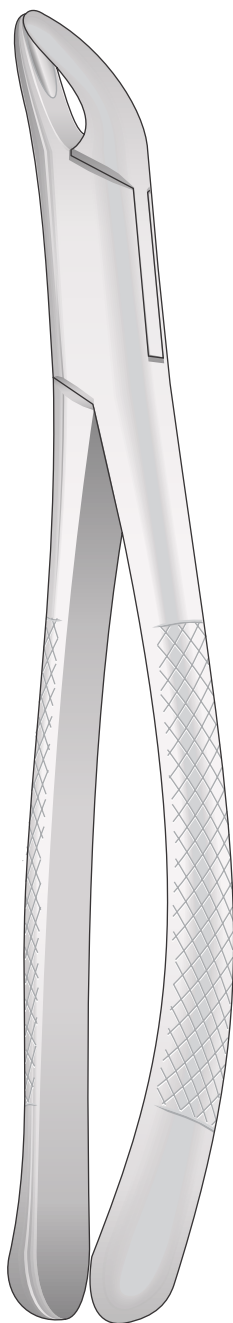
Zahnzangen, Amerikanische Form  
Extracting Forceps, American Pattern  
Pinze per estrazione, Forma Americana  
Pinzas da extracción, Forma Americana  
Daviers, Forme Américaine



**TOMES**  
**NMI-AM-69**  
Fig.69

Obere und Untere  
Upper and lower  
Superiori e inferiori  
Superiores y inferiores  
Supérieures et inférieures

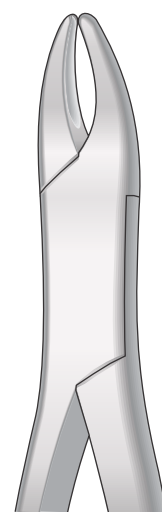
Wurzeln  
Roots  
Radici  
Raíces  
Racines



**CRYER**  
**NMI-AM-1NMI-51**  
Fig.1NMI-51

Untere  
Lower  
Inferiori  
Inferiores  
Inférieures

Schneidezähne, Prämolaren, Wurzeln  
Incisors, Premolars, Roots  
Incisivi, premolari, radici  
Incisivos, premolares, raíces  
Incisives, prémolaires, racines

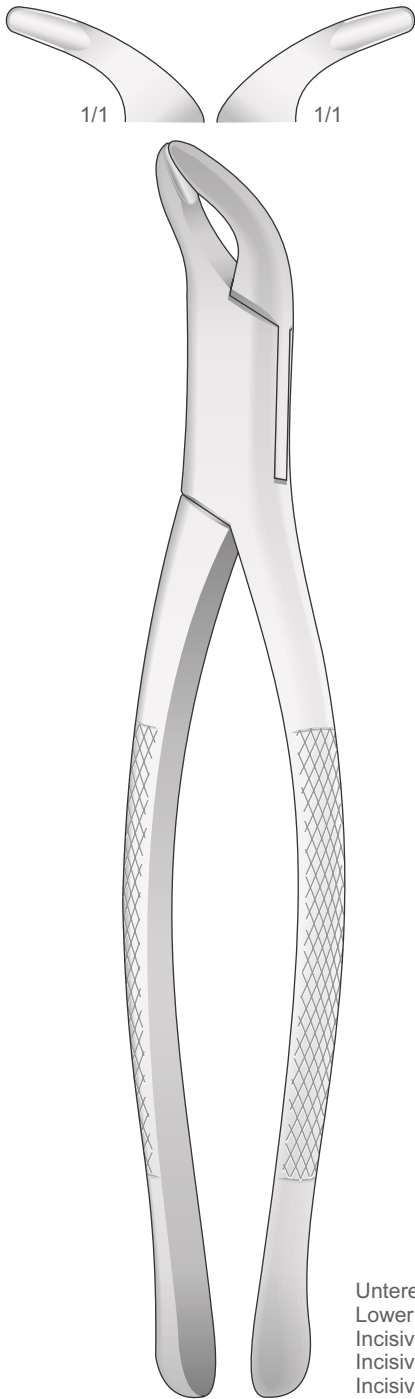


**HULL**  
**NMI-AM-101**  
Fig. 101

Für Eckzähne und Prämolaren,  
Universalzange und Kinderzange  
For canines and Premolars,  
Universal and Tooth forceps for children  
Canini e premolari,  
universale e per bambini  
Caninos y premolares,  
universal y para niños  
Canines et prémolaires,  
universel et pour enfants

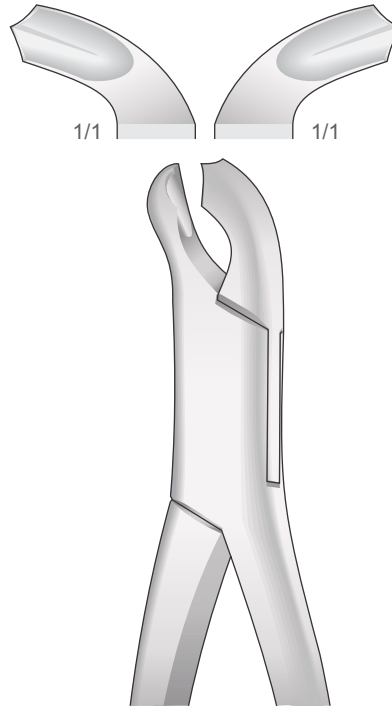


Zahnzangen, Amerikanische Form  
Extracting Forceps, American Pattern  
Pinze per estrazione, Forma Americana  
Pinzas da extracción, Forma Americana  
Daviers, Forme Américaine



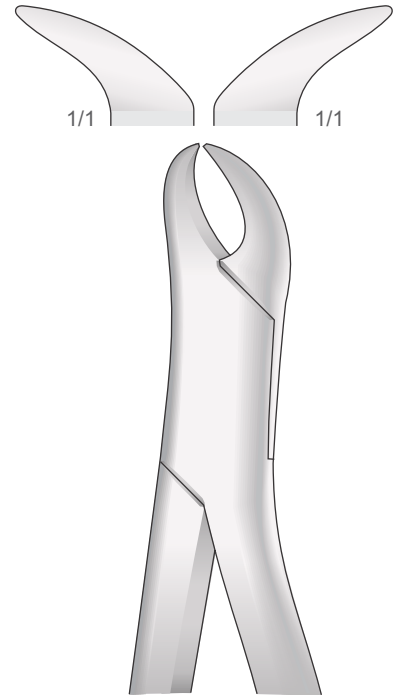
**NMI-AM-203**  
Fig. 203

Untere Schneidezähne, Prämolaren, Wurzeln  
Lower Incisors, Premolars, Roots  
Incisivi, premolari, radici inferiori  
Incisivos, premolares, raices inferiores  
Incisives, prémolaires, racines inférieures



**NMI-AM-17**  
Fig. 17

Untere Molaren  
Lower Molars  
Molari inferiori  
Molares inferiores  
Molaires inférieures

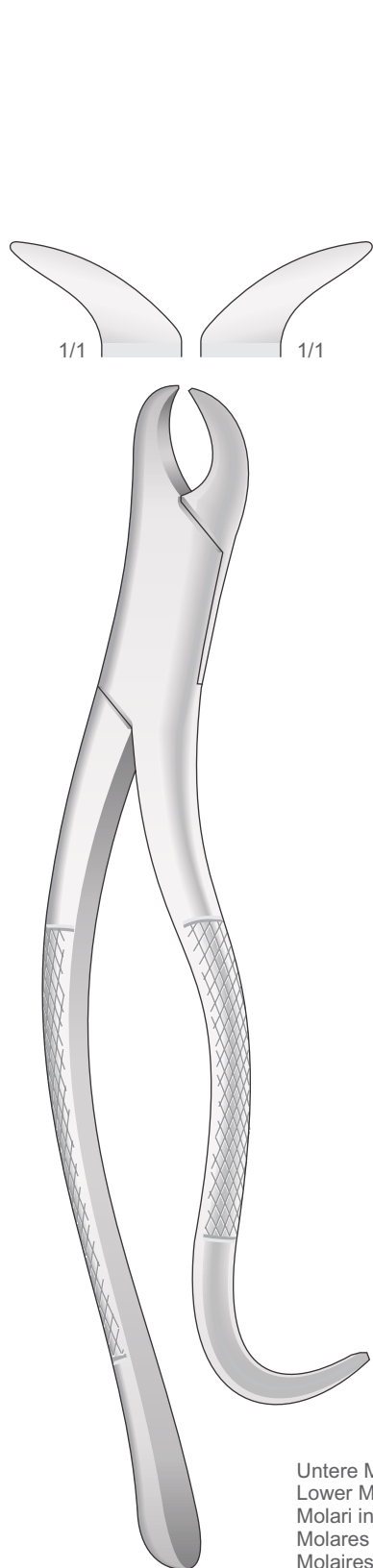


**NMI-AM-23**  
Fig. 23

Untere Molaren  
Lower Molars  
Molari inferiori  
Molares inferiores  
Molaires inférieures

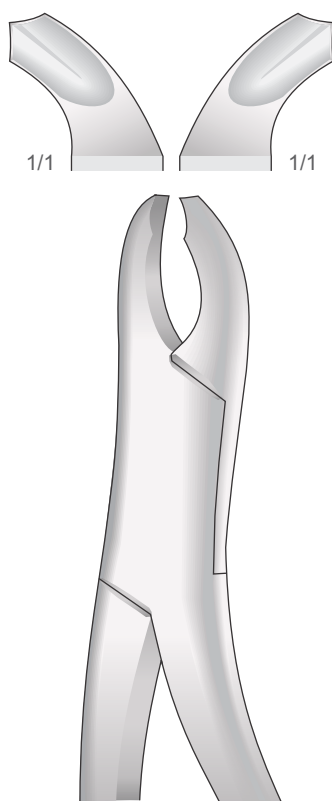


Zahnzangen, Amerikanische Form  
Extracting Forceps, American Pattern  
Pinze per estrazione, Forma Americana  
Pinzas da extracción, Forma Americana  
Daviers, Forme Américaine



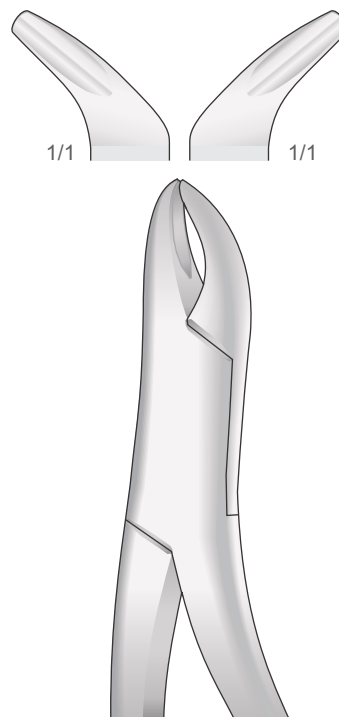
**NMI-AM-16**  
Fig. 16

Untere Molaren  
Lower Molars  
Molari inferiori  
Molares inferiores  
Molaires inférieures



**HARRIS**  
**NMI-AM-15**  
Fig. 15

Untere Molaren  
Lower Molars  
Molari inferiori  
Molares inferiores  
Molaires inférieures

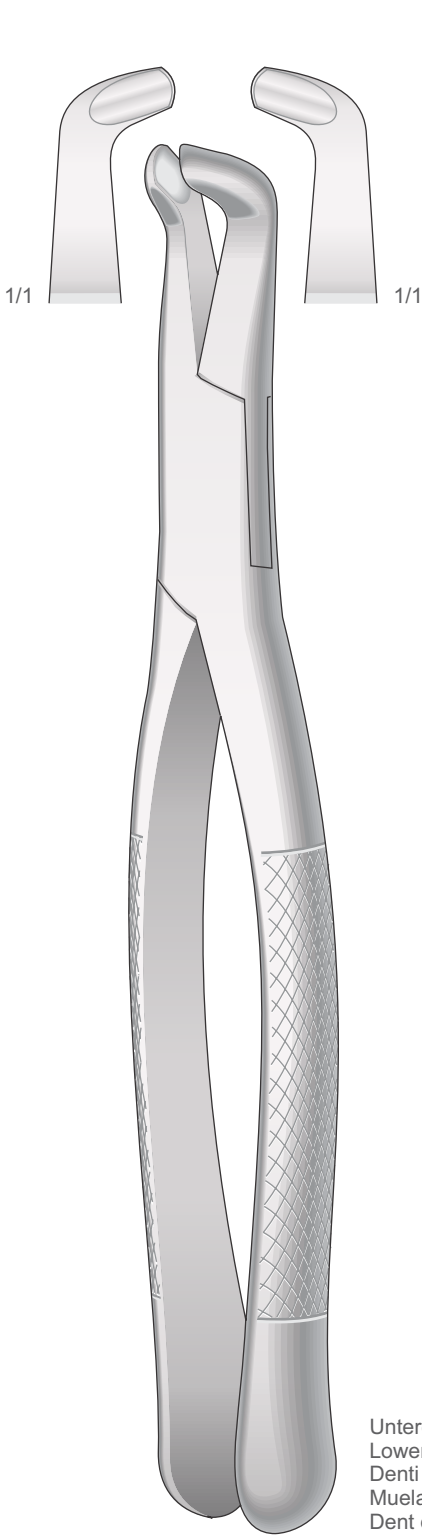


**NMI-AM-103**  
Fig. 103

Untere Schneidezähne, Prämolaren, Wurzeln  
Lower Incisors, Premolars, Roots  
Incisivi, premolari, radici inferiori  
Incisivos, premolares, raices inferiores  
Incisives, prémolaires, racines inférieures

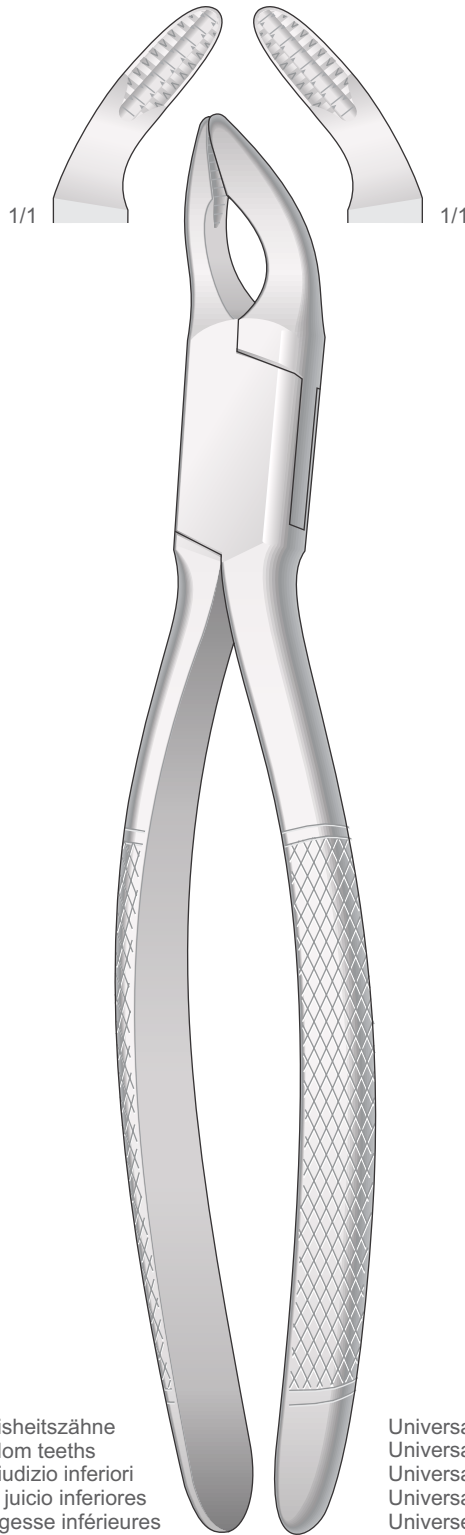


Zahnzangen, Amerikanische Form  
Extracting Forceps, American Pattern  
Pinze per estrazione, Forma Americana  
Pinzas da extracción, Forma Americana  
Daviers, Forme Américaine



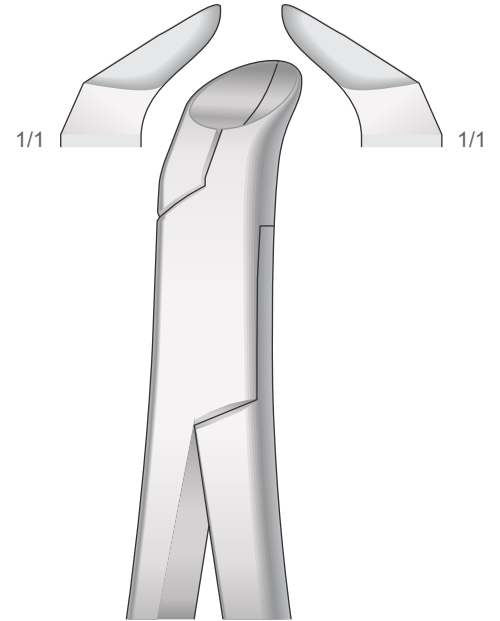
**NMI-AM-222**  
Fig. 222

Untere Weisheitszähne  
Lower wisdom teeth  
Denti del giudizio inferiori  
Muelas del juicio inferiores  
Dent de sagesse inférieures



**COHEN**  
**NMI-AM-250**

Universal  
Universal  
Universale  
Universal  
Universel

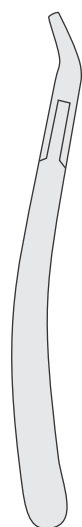
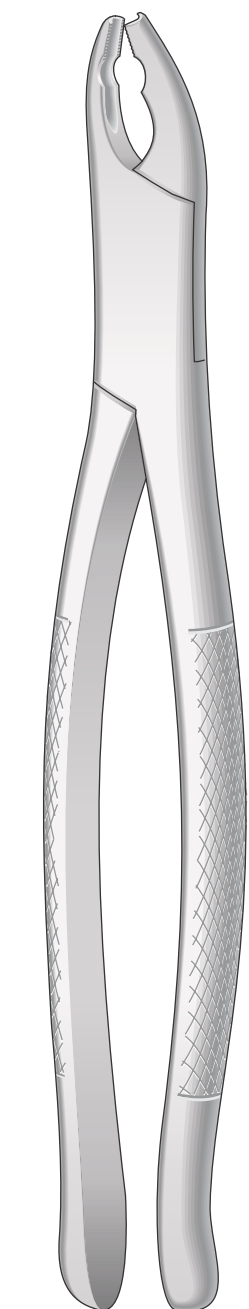
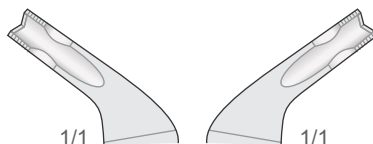
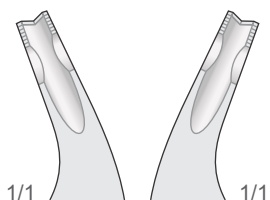


**PHYSICK**  
**NMI-AM-5**  
Fig. 5

Untere Weisheitszähne  
Lower wisdom teeth  
Denti del giudizio inferiori  
Muelas del juicio inferiores  
Dent de sagesse inférieures



Zahnzangen, Amerikanische Form  
Extracting Forceps, American Pattern  
Pinze per estrazione, Forma Americana  
Pinzas da extracción, Forma Americana  
Daviers, Forme Américaine



Obere  
Upper  
Superiori  
Superiores  
Supérieures

Prämolaren, Schneidezähne und Wurzeln  
Bicuspids, incisors and roots  
Premolari, incisivi e radici  
Premolares, incisivos y raices  
Premolaires, incisives et racines



Untere  
Lower  
Inferiori  
Inferiores  
Inférieures

Prämolaren, Schneidezähne und Wurzeln  
Bicuspids, incisors and roots  
Premolari, incisivi e radici  
Premolares, incisivos y raices  
Premolaires, incisives et racines

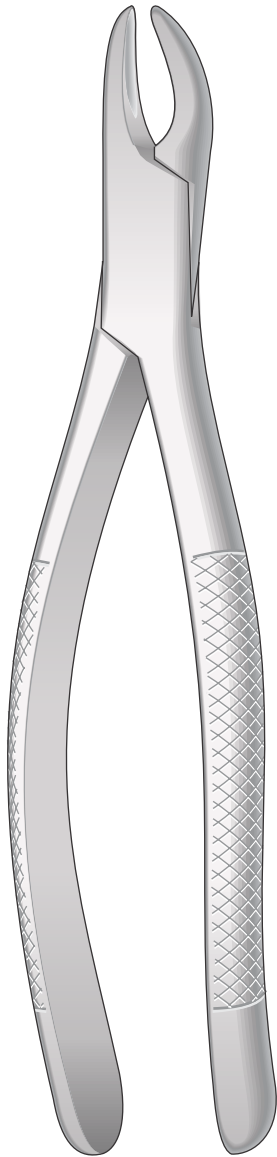
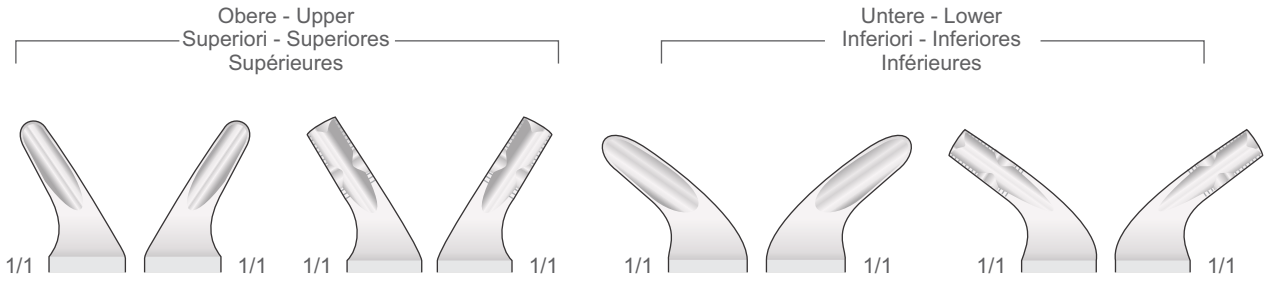
**NMI-AM-150X**  
Fig. 150AS

**NMI-AM-1NMI-51X**  
Fig. 1NMI-51AS

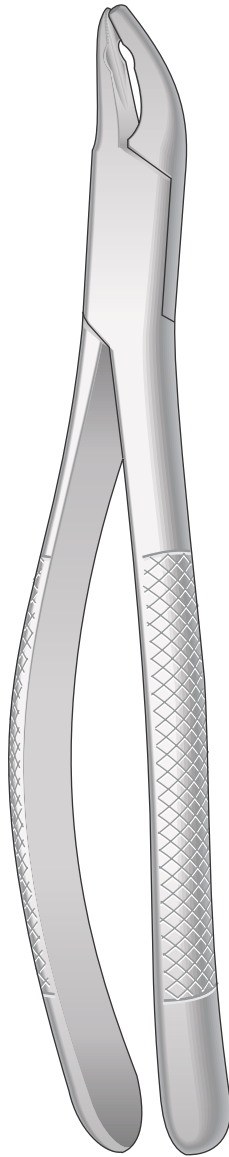


Zahnzangen, Amerikanische Form  
Extracting Forceps, American Pattern  
Pinze per estrazione, Forma Americana  
Pinzas da extracción, Forma Americana  
Daviers, Forme Américaine

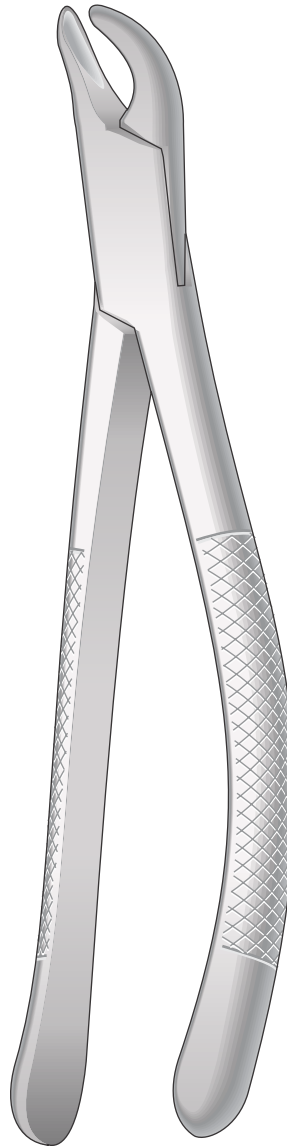
Für Kinder  
For children  
Per bambini  
Para niños  
Pour enfants



CRYER  
NMI-AM-150S  
Fig.150 S



NMI-AM-150AS  
Fig.150 XAS



CRYER  
NMI-AM-151S  
Fig.151 S



NMI-AM-151AS  
Fig.151 XAS

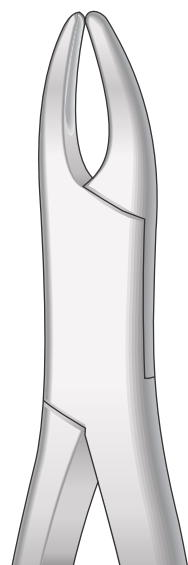
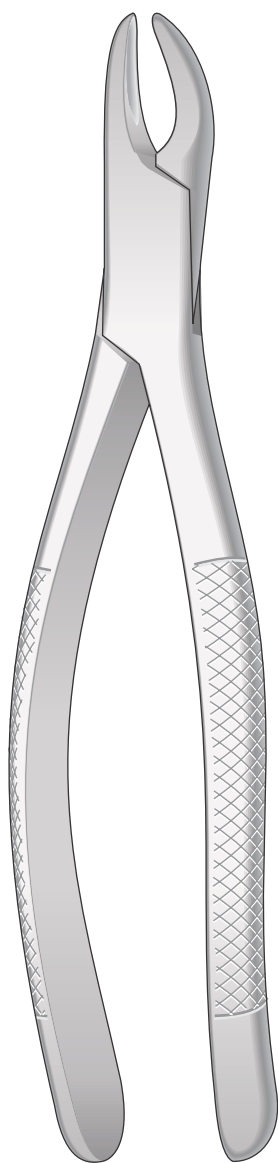
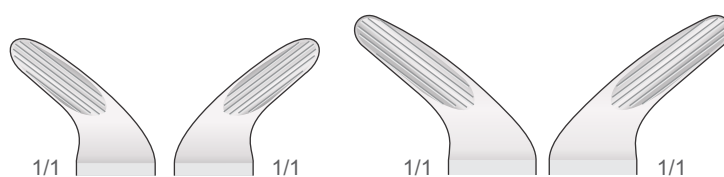
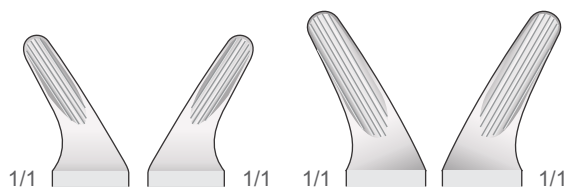


Zahnzangen, Amerikanische Form  
Extracting Forceps, American Pattern  
Pinze per estrazione, Forma Americana  
Pinzas da extracción, Forma Americana  
Daviers, Forme Américaine

Geriefte - Serrated - Striata - Estriadas - Striées

Obere Schneidezähne, Prämolaren, Wurzeln  
Upper incisors, premolars, roots  
Incisivi, premolari e radici superiori  
Incisivos, premolares y raíces superiores  
Incisives, premolaires et racines supérieures

Untere Schneidezähne, Prämolaren, Wurzeln  
Lower incisors, premolars, roots  
Incisivi, premolari e radici inferiori  
Incisivos, premolares y raíces inferiores  
Incisives, premolaires et racines inférieures

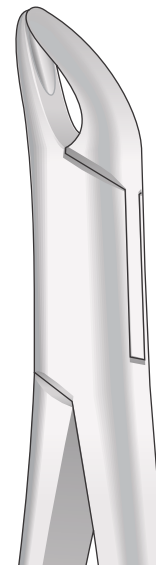
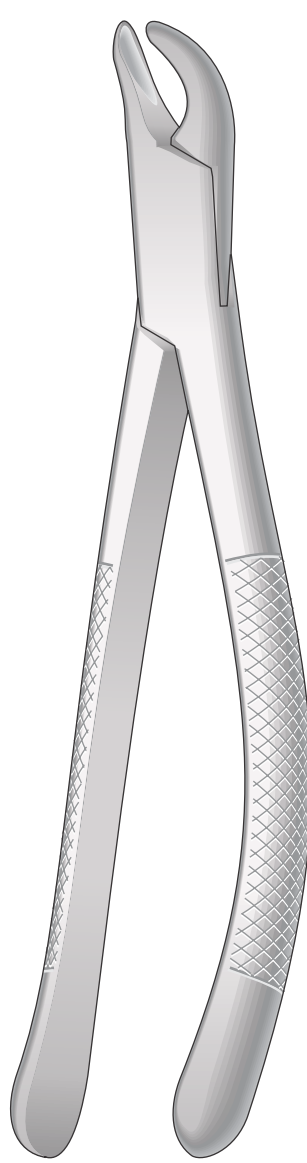


CRYER  
**NMI-AMG-150**  
Fig. 150

Für Erwachsene  
For adults  
Per adulti  
Para adultos  
Pour adults

Für Kinder  
For children  
Per bambini  
Para niños  
Pour enfants

CRYER  
**NMI-AMG-150S**  
Fig.150 S



CRYER  
**NMI-AMG-1NMI-51**  
Fig. 1NMI-51

Für Erwachsene  
For adults  
Per adulti  
Para adultos  
Pour adults

Für Kinder  
For children  
Per bambini  
Para niños  
Pour enfants

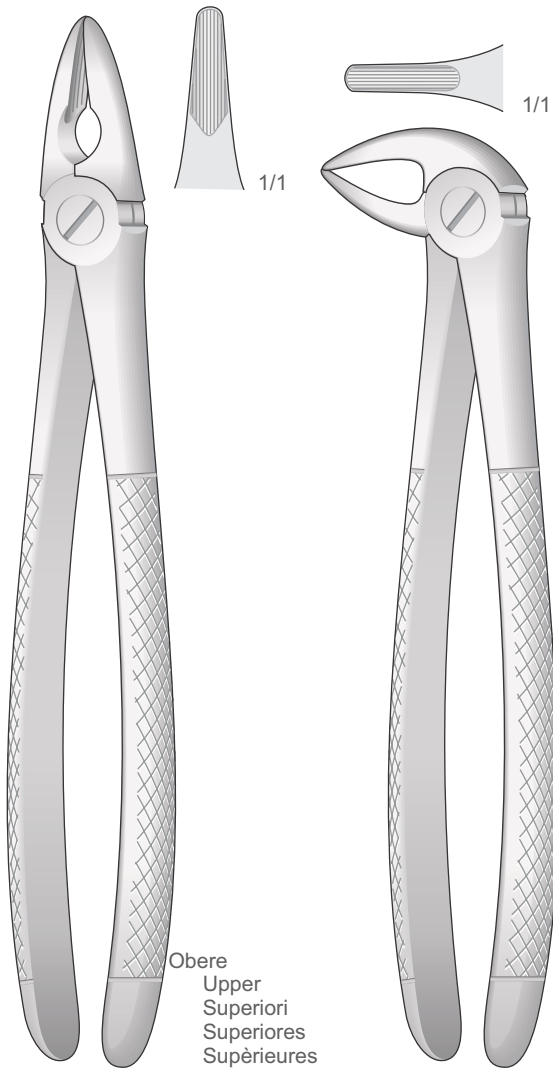
CRYER  
**NMI-AMG-151S**  
Fig.151 S



Zahnzangen  
Extracting Forceps  
Pinze per estrazione  
Pinzas da extracción  
Daviers

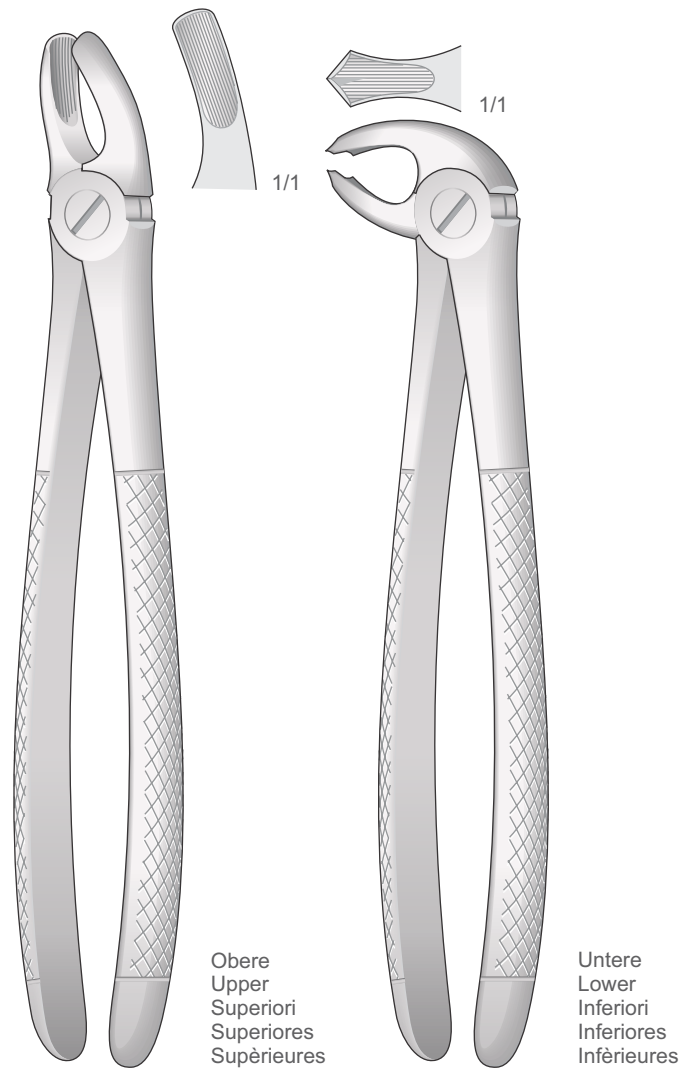
Schneidezähne, Eckzähne, Wurzeln  
Incisors, bicuspid and roots  
Incisivi, canini e radici  
Incisivos, caninos y raíces  
Incisives, canines et racines

Molaren  
Molars  
Molari  
Molares  
Molaires



MEAD  
NMI-MD-1

MEAD  
NMI-MD-3



MEAD  
NMI-MD-2

MEAD  
NMI-MD-4



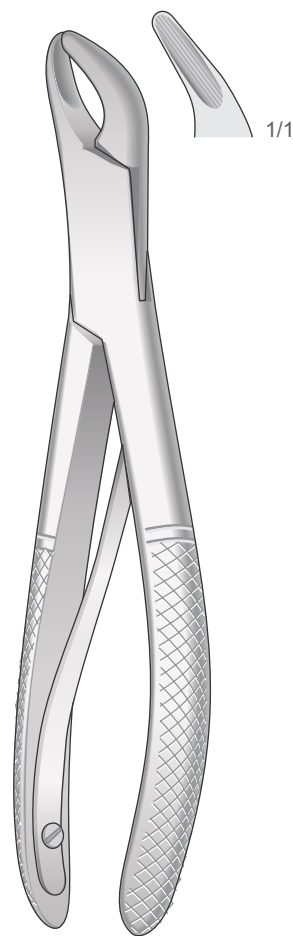
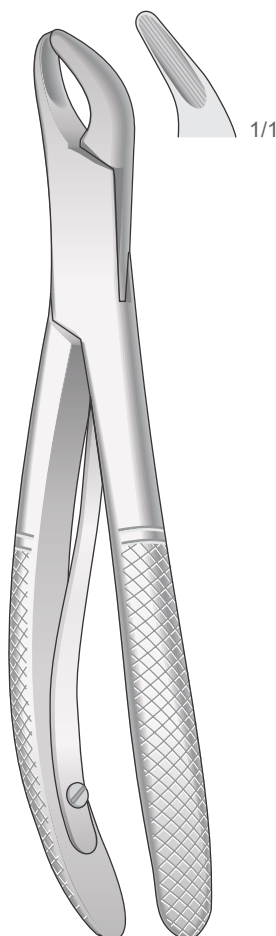
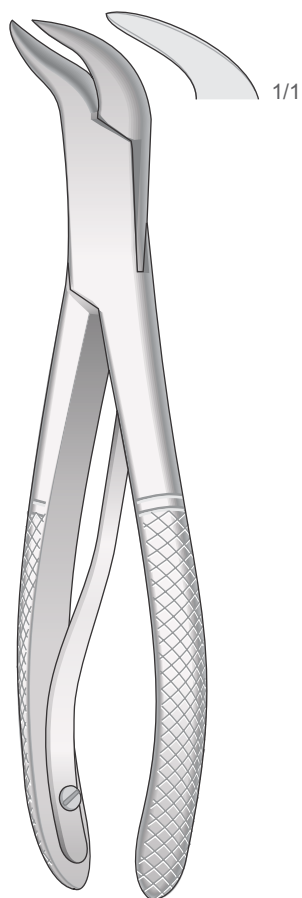
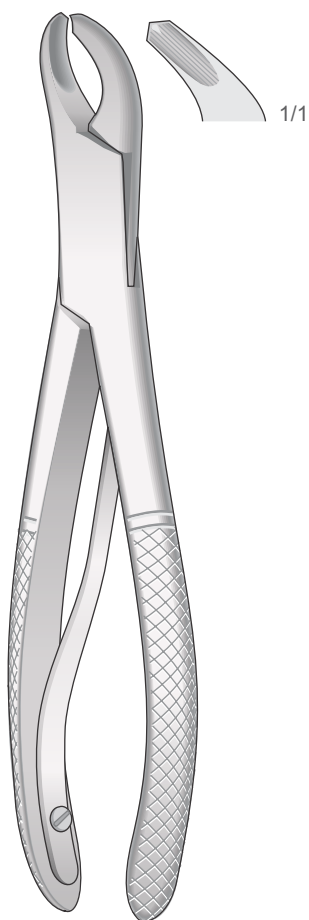
Kinderzahnzangen, Amerikanische Form  
 Extracting Forceps for children, American Pattern  
 Pinze per estrazione per bambini, Forma Americana  
 Forceps dentales para niños, Forma Americana  
 Daviers pour enfants, Forme Américaine

Molaren  
 Pedo Lower Molars  
 Molari  
 Molares  
 Molaires

Molaren  
 Pedo Lower Molars  
 Molari  
 Molares  
 Molaires

Zähne und wurzeln  
 Pedo upper incisors  
 Bicuspids and roots  
 Denti e radici  
 Dientes y raíces  
 Dentes et racines

Zähne und wurzeln  
 Pedo lower incisors  
 Bicuspids and roots  
 Denti e radici  
 Dientes y raíces  
 Dentes et racines



**NMI-PEB-17S**  
Fig. 17SK

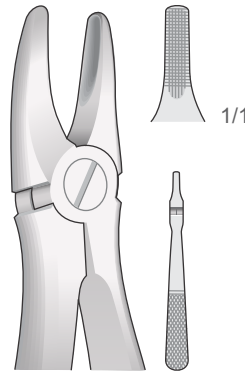
**NMI-PEB-23S**  
Fig. 23SK

**NMI-PEB-150S**  
Fig. 150SK

**NMI-PEB-151S**  
Fig. 151SK

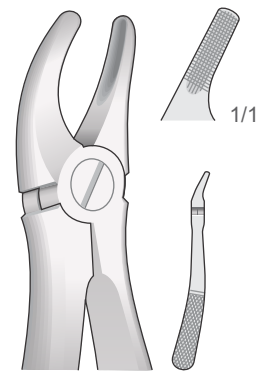


Kinderzahnzangen  
Extracting Forceps for children  
Pinze per estrazione per bambini  
Forceps dentales para niños  
Daviers pour enfants



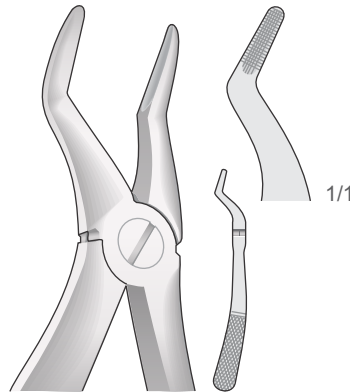
**NMI-PEB-1**  
Fig. 137

Obere Schneidezähne  
Upper Incisors  
Incisivi superiori  
Incisivos superiores  
Incisives supérieures



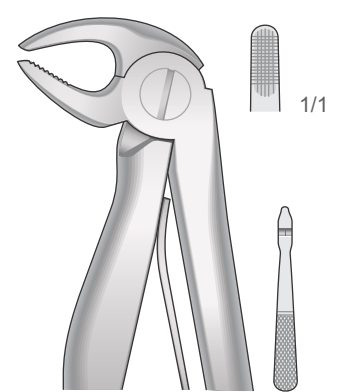
**NMI-PEB-2**  
Fig. 139

Obere Prämolaren  
Upper Premolars  
Premolari superiori  
Premolares superiores  
Prémolaires supérieures



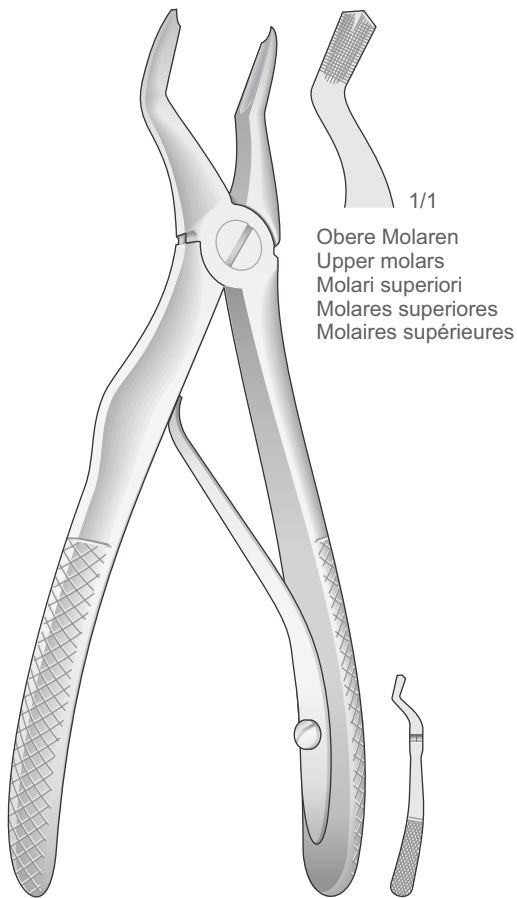
**NMI-PEB-4**  
Fig. 51S

Obere Wurzeln  
Upper roots  
Radici superiori  
Raíces superiores  
Racines supérieures



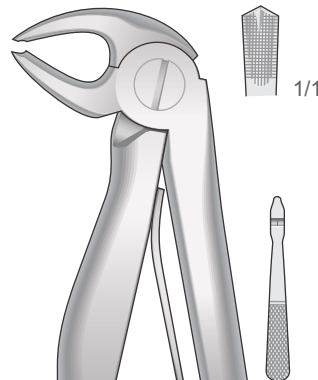
**NMI-PEB-5**  
Fig. 5

Untere Schneidezähne  
Lower incisors  
Incisivi inferiori  
Incisivos inferiores  
Incisives inférieures



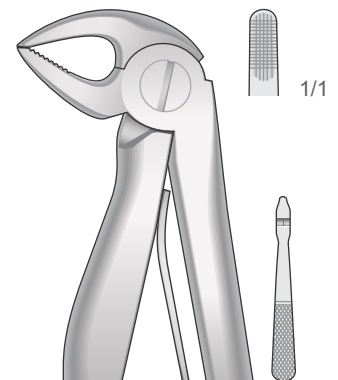
**NMI-PEB-3**

Obere Molaren  
Upper molars  
Molari superiori  
Molares superiores  
Molaires supérieures



**NMI-PEB-6**  
Fig. 6

Untere Molaren  
Lower Molars  
Molari inferiori  
Molares inferiores  
Molaires inférieures

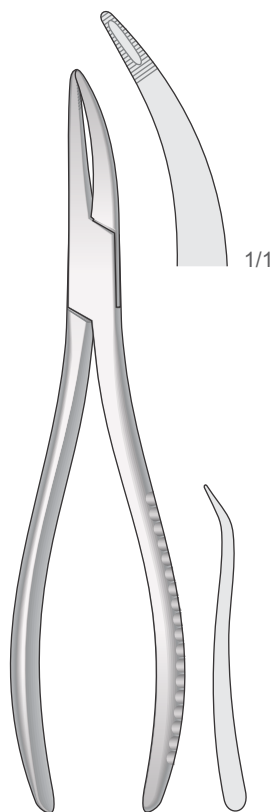


**NMI-PEB-7**  
Fig. 7

Untere Wurzeln  
Lower roots  
Radici inferiori  
Raíces inferiores  
Racines inférieures



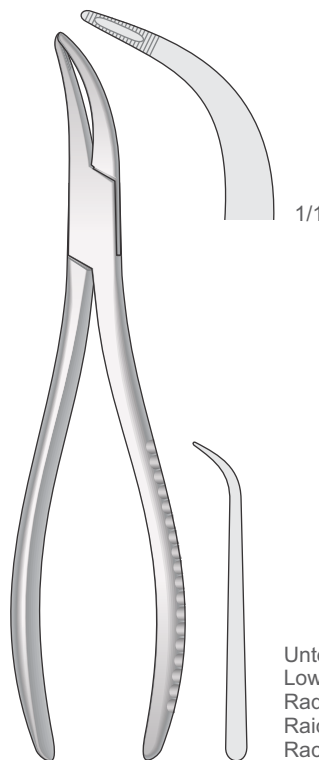
Zahnzangen  
Extracting Forceps  
Pinze per estrazione  
Pinzas da extracción  
Daviers



1/1

Obere Wurzeln, Universal  
Upper roots, Universal  
Radici superiori, Universale  
Raices superiores, Universal  
Racines superieures, Universel

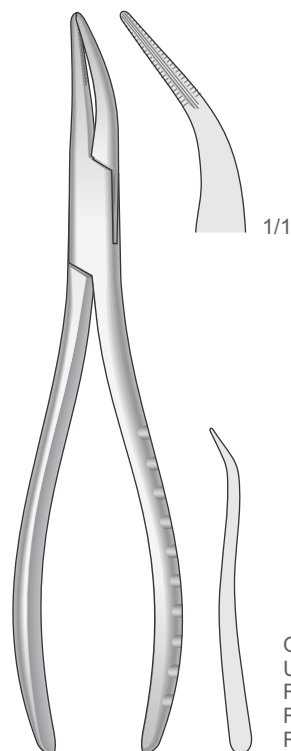
**WITZEL**  
**NMI-DK-26**  
170 mm



1/1

Untere Wurzeln, Universal  
Lower roots, Universal  
Radici inferiori, Universale  
Raices inferiores, Universal  
Racines inferieures, Universel

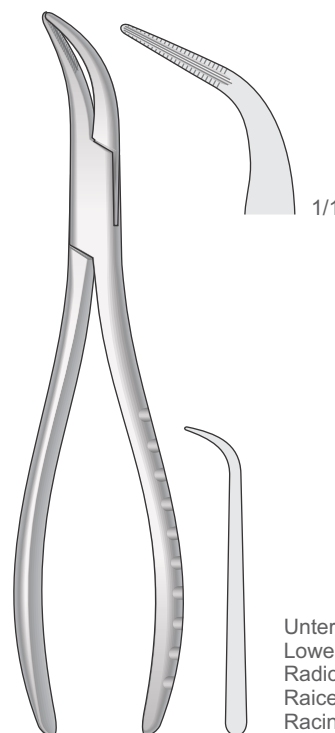
**WITZEL**  
**NMI-DK-28**  
165 mm



1/1

Obere Wurzeln, Universal  
Upper roots, Universal  
Radici superiori, Universale  
Raices superiores, Universal  
Racines superieures, Universel

**NMI-400 (300)**  
165 mm



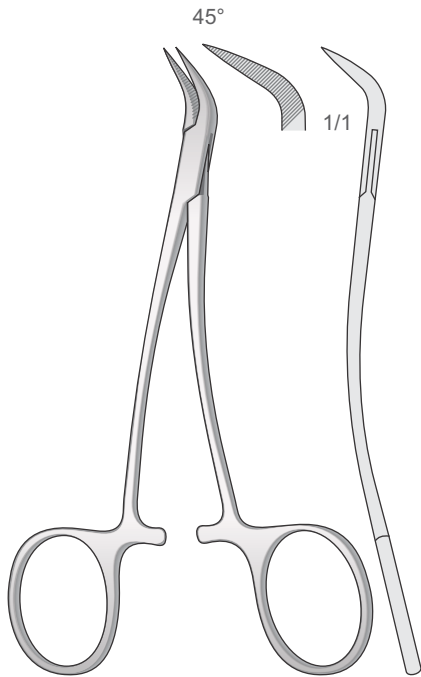
1/1

Untere Wurzeln, Universal  
Lower roots, Universal  
Radici inferiori, Universale  
Raices inferiores, Universal  
Racines inferieures, Universel

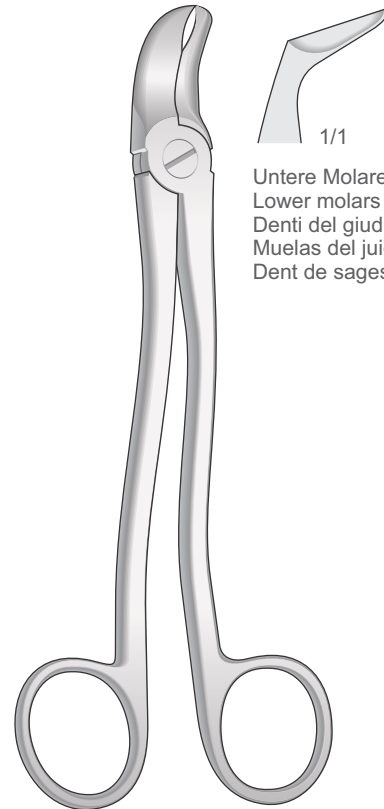
**NMI-401 (301)**  
160 mm



Wurzelfragmentinstrumente  
Root Fragment Forceps  
Strumenti per frammenti di radici  
Instrumentos para fragmentos de raíces  
Instruments pour fragments de racines



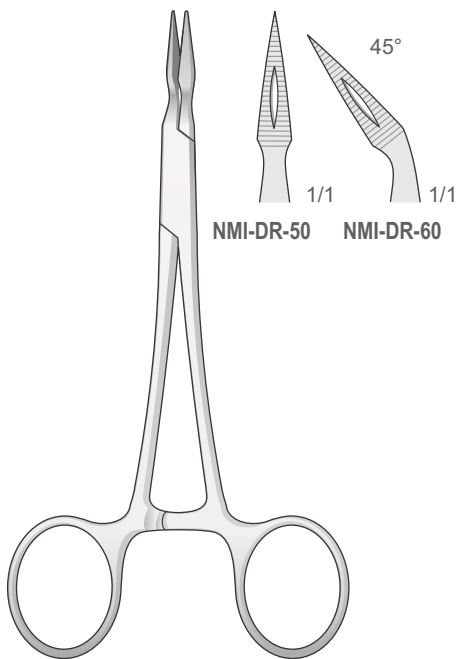
PEET  
NMI-DR-40  
120 mm



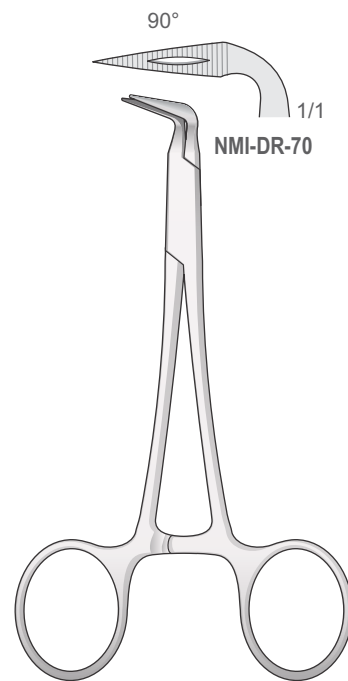
NMI-RO-1  
175 mm

1/1  
Untere Molaren und Weisheitszähne  
Lower molars and wisdom teeth  
Denti del giudizio e molari inferiori  
Muelas del juicio y molares inferiores  
Dent de sagesse et molaires inférieures

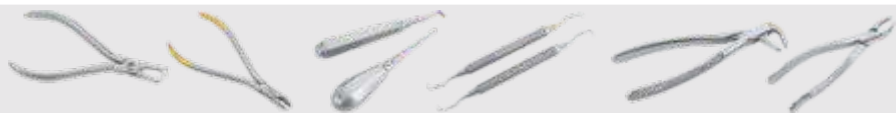
Wurzelfragmente  
Root fragments  
Frammenti di radici  
Fragmentos de raíces  
Fragments de racines



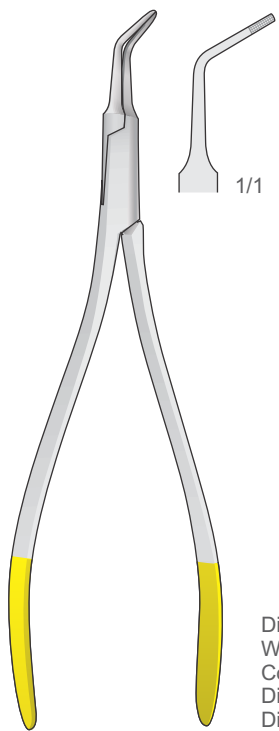
STIEGLITZ  
NMI-DR-50/NMI-DR-60  
140 mm



STIEGLITZ  
NMI-DR-70  
120 mm

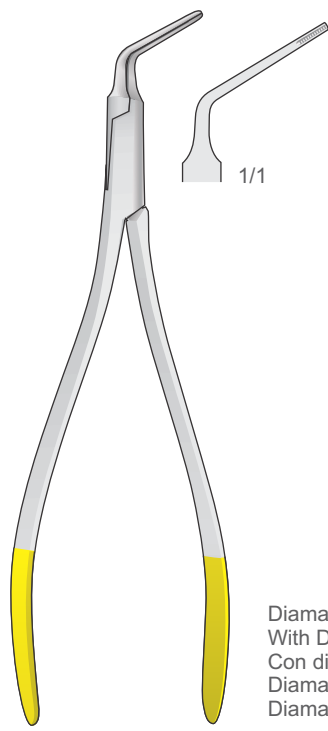


Wurzelfragmentinstrumente  
Root Fragment Forceps  
Strumenti per frammenti di radici  
Instrumentos para fragmentos de raíces  
Instruments pour fragments de racines



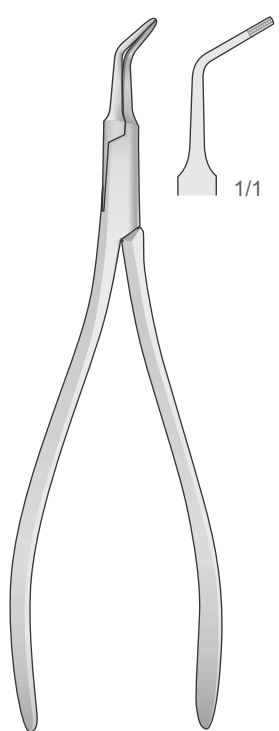
Diamantiert  
With Diamond  
Con diamante  
Diamantada  
Diamantées

**NMI-DA-01M**  
130 mm

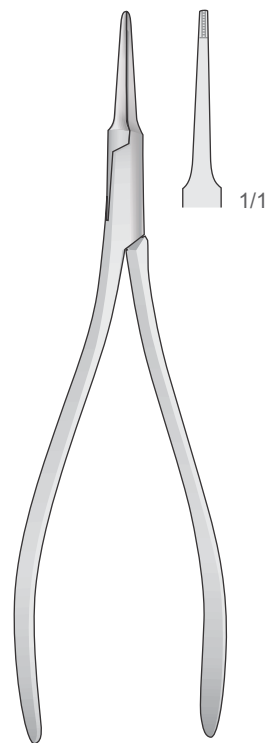


Diamantiert  
With Diamond  
Con diamante  
Diamantada  
Diamantées

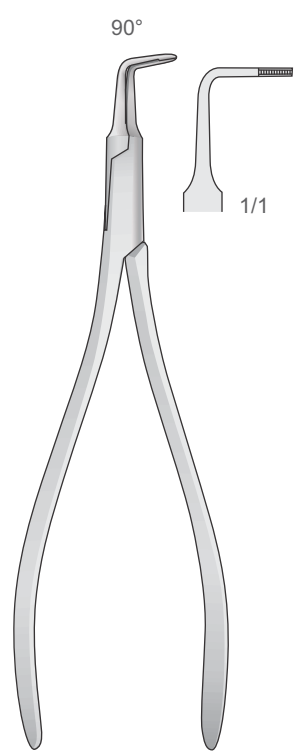
**NMI-DA-10**  
130 mm



**NMI-DA-01**  
130 mm



**NMI-DA-02**  
130 mm



**NMI-DA-03**  
125 mm

# DENTAL Instruments

Extracting Forceps

**Root Elevators**

Scalpel Blades and Handles

**Surgical Scissors**

Tissue and Dressing Forceps

Needle Holders

Hemostatic Forceps | Towel Clamps

Retractors | Mouth Gags

**Implantology**

Periosteal | Curettes | Rongeurs

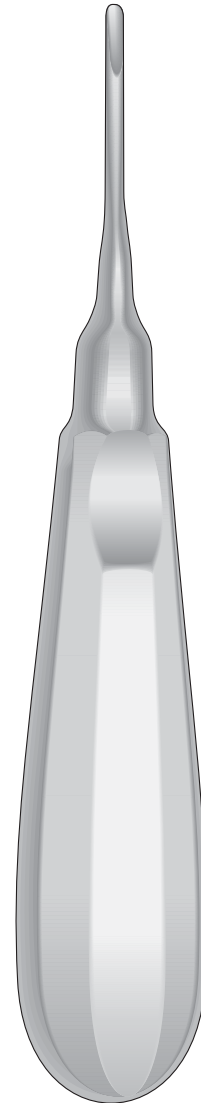
Dental Restoration | Periodontology

**Suction Tube**

Orthodontics

Crown Instruments | Laboratory

Instrument Maintenance | Sterilization



44-74

**Root Elevators**

Wurzelheber

Elevatori per radici

Elevadores para raíces

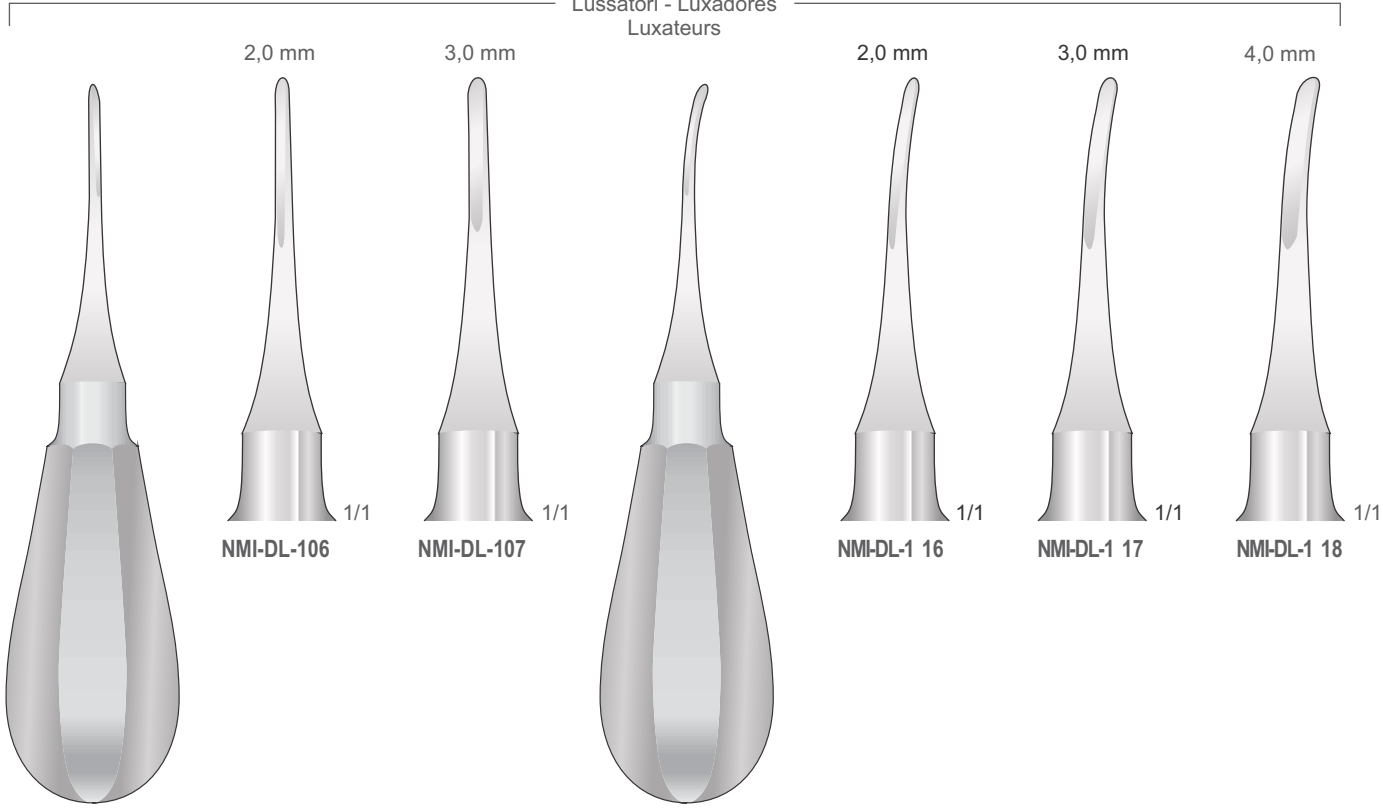
Élévateurs pour racines



Wurzelheber  
Root Elevators  
Leve per radici  
Elevadores para raíces  
Elevateurs à racines

**SMALL HANDLE**

Luxatoren - Luxators  
Lussatori - Luxadores  
Luxateurs



2,0 mm  
NMI-DL-106 1/1

3,0 mm  
NMI-DL-107 1/1

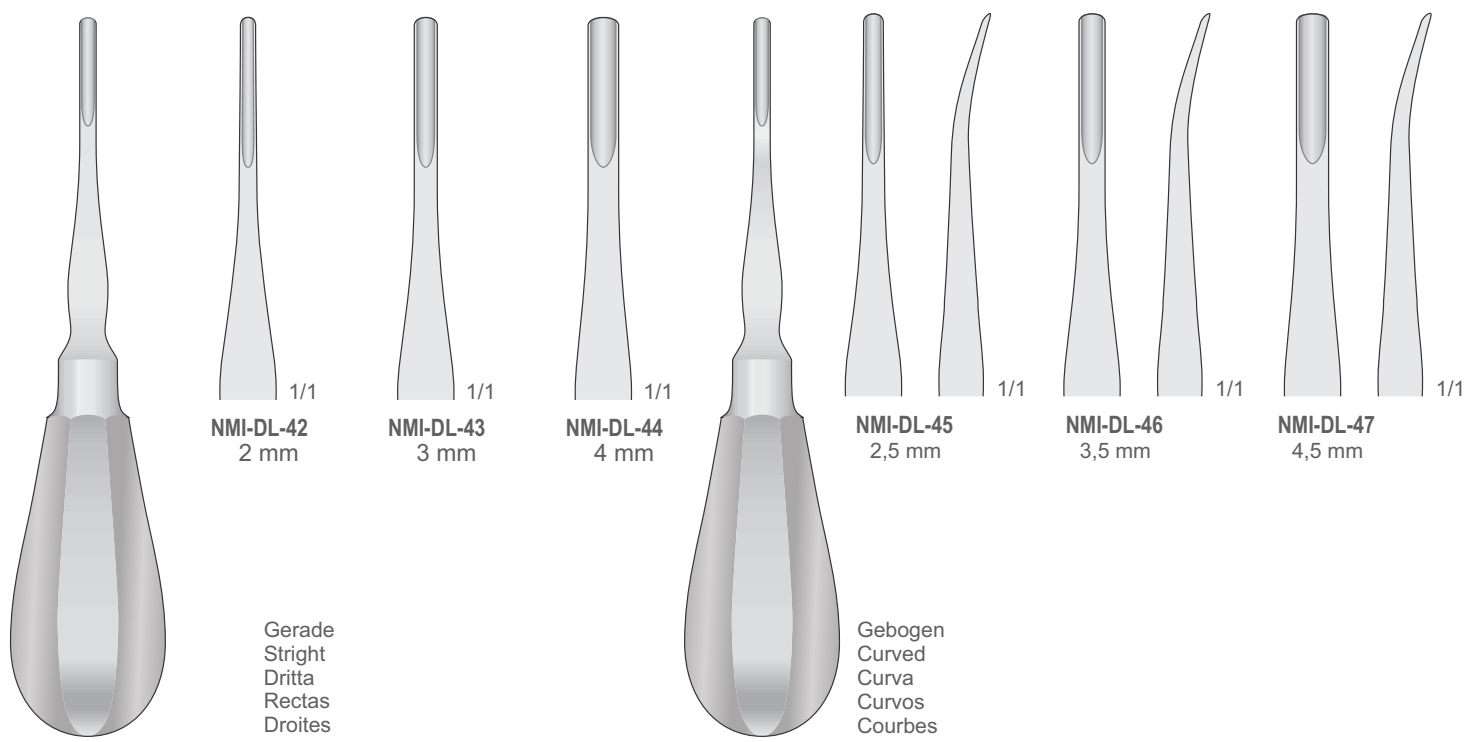
2,0 mm  
NMI-DL-1 16 1/1

3,0 mm  
NMI-DL-1 17 1/1

4,0 mm  
NMI-DL-1 18 1/1

NMI-DL-106/NMI-DL-107  
120 mm

NMI-DL-1 16/NMI-DL-1 18  
120 mm



NMI-DL-42  
2 mm

NMI-DL-43  
3 mm

NMI-DL-44  
4 mm

NMI-DL-45  
2,5 mm

NMI-DL-46  
3,5 mm

NMI-DL-47  
4,5 mm

Gerade  
Stright  
Dritta  
Rectas  
Droites

Gebogen  
Curved  
Curva  
Curvos  
Courbes

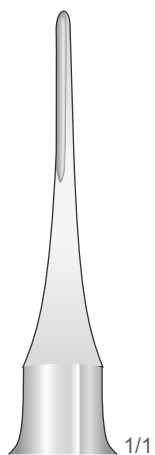
BEIN  
NMI-DL-42/NMI-DL-44

NMI-DL-45/NMI-DL-47



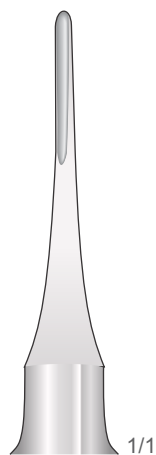
Wurzelheber  
Root Elevators  
Leve per radici  
Elevadores para raíces  
Elevateurs à racines

2,0 mm



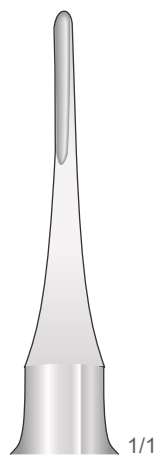
**NMI-DL-81**  
150 mm

2,5 mm



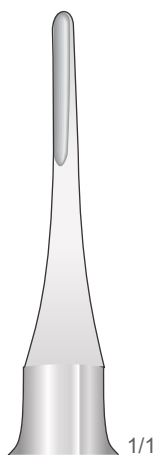
**NMI-DL-82**  
150 mm

3,0 mm



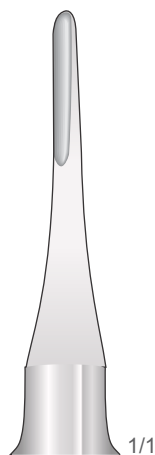
**NMI-DL-83**  
150 mm

3,5 mm



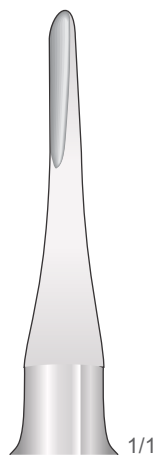
**NMI-DL-84**  
150 mm

4,0 mm



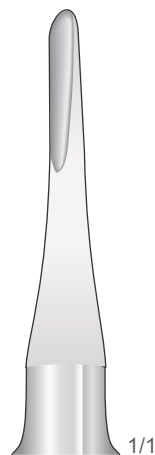
**NMI-DL-85**  
150 mm

4,5 mm

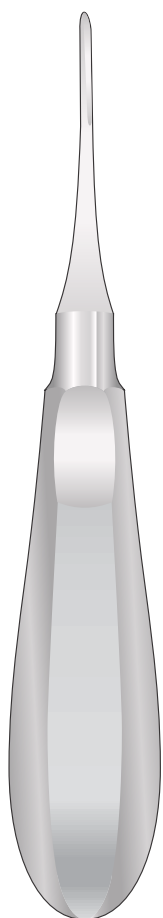


**NMI-DL-86**  
150 mm

5,0 mm

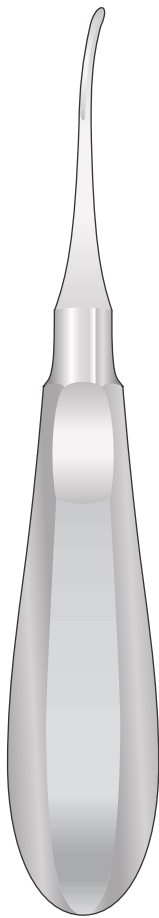


**NMI-DL-87**  
150 mm



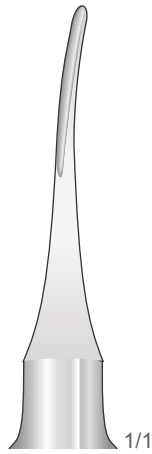
**NMI-DL-81/NMI-DL-87**  
150 mm

Wurzelheber  
Root Elevators  
Leve per radici  
Elevadores para raíces  
Elevateurs à racines



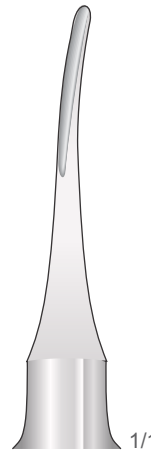
**NMI-DL-91/NMI-DL-97**  
150 mm

2,0 mm



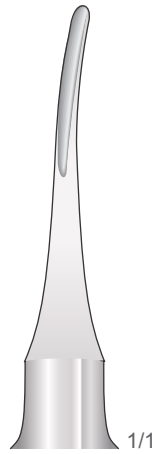
**NMI-DL-91**  
150 mm

2,5 mm



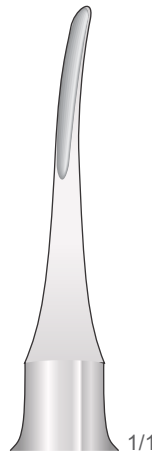
**NMI-DL-92**  
150 mm

3,0 mm



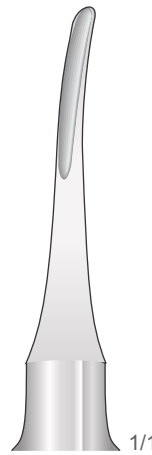
**NMI-DL-93**  
150 mm

3,5 mm



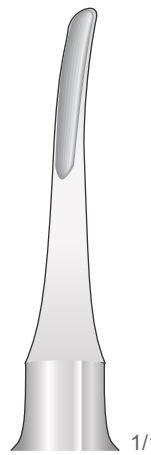
**NMI-DL-94**  
150 mm

4,0 mm



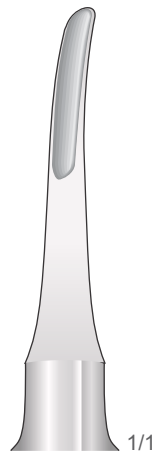
**NMI-DL-95**  
150 mm

4,5 mm



**NMI-DL-96**  
150 mm

5,0 mm



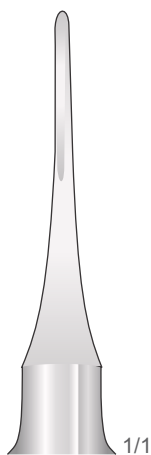
**NMI-DL-97**  
150 mm



Wurzelheber  
Root Elevators  
Leve per radici  
Elevadores para raíces  
Elevateurs à racines

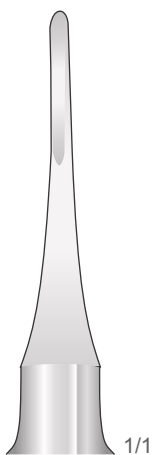
Luxatoren  
Luxators  
Lussatori  
Luxadores  
Luxateurs

2,0 mm



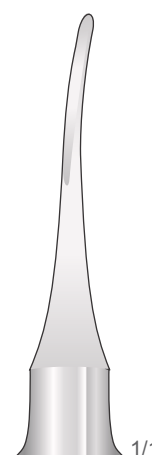
**NMI-DL-102**  
150 mm

3,0 mm



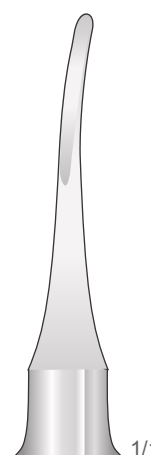
**NMI-DL-103**  
150 mm

2,0 mm



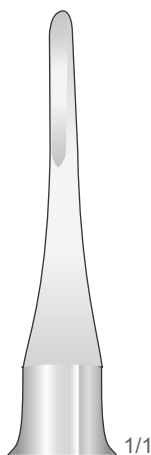
**NMI-DL-1 12**  
150 mm

3,0 mm



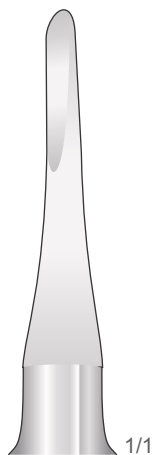
**NMI-DL-1 13**  
150 mm

4,0 mm



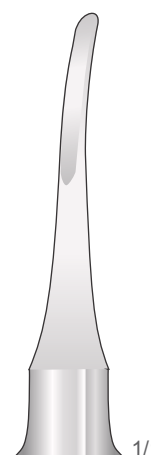
**NMI-DL-104**  
150 mm

5,0 mm



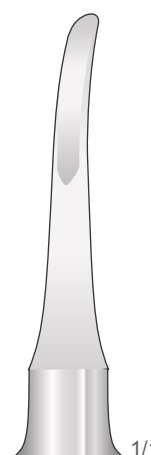
**NMI-DL-105**  
150 mm

4,0 mm



**NMI-DL-1 14**  
150 mm

5,0 mm



**NMI-DL-1 15**  
150 mm

**NMI-DL-102/NMI-DL-105**  
150 mm

**NMI-DL-1 12/NMI-DL-1 15**  
150 mm



Wurzelheber  
Root Elevators  
Leve per radici  
Elevadores para raíces  
Elevateurs à racines

Wurzelspitzenheber  
Root fragment Elevators  
Leve per frammenti di radice  
Elevadores para fragmentos de raíces  
Elévateurs de fragments de racines

Gezahnt  
Serrated  
Dentellata  
Dentada  
Dentelé



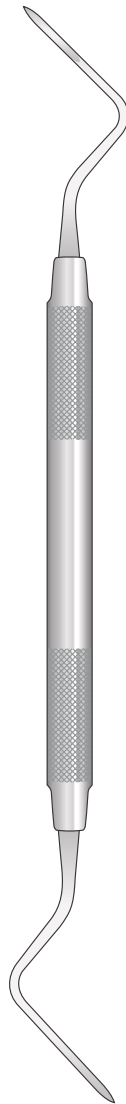
HEIDBRINK  
NMI-HE-1  
140 mm



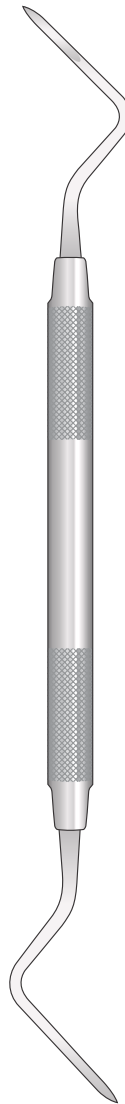
HEIDBRINK  
NMI-HE-2  
140 mm



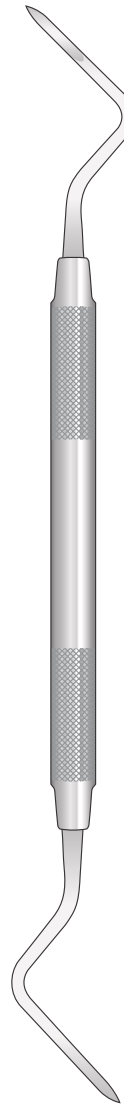
HEIDBRINK  
NMI-HE-3  
140 mm



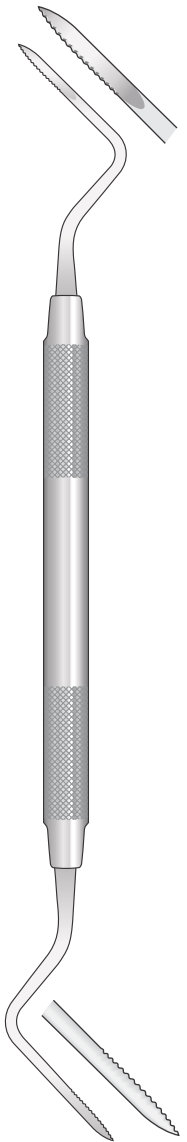
HEIDBRINK  
NMI-725-1/2  
195 mm



HEIDBRINK  
NMI-725-3/4  
195 mm



HEIDBRINK  
NMI-725-5/6  
195 mm



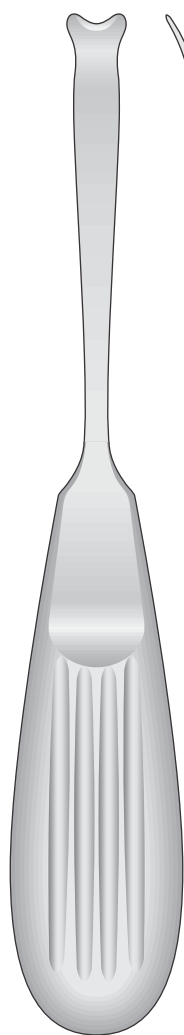
HEIDBRINK  
NMI-725-3/4S  
195 mm



Wurzelheber  
Root Elevators  
Leve per radici  
Elevadores para raíces  
Elevateurs à racines

Extraktionshebel für obere Weisheitszähne  
Luxator for upper wisdom teeth  
Leva per estrazione dente del giudizio superiore  
Elevador de extracción de muelas del juicio superiores  
Levier d'extraction pour dent de sagesse supérieures

Wurzelheber  
Root Elevators  
Leve per radici  
Elevadores para raíces  
Elevateurs de racines



ROSIN  
NMI-DL-58  
160 mm



WARWICK-JAMES  
NMI-DL-20  
160 mm



WARWICK-JAMES  
NMI-DL-21  
155 mm



WARWICK-JAMES  
NMI-DL-22  
155 mm

Obere  
Upper  
Superiori  
Superiores  
Supérieures

Untere  
Lower  
Inferiori  
Inferiores  
Inférieures

Untere  
Lower  
Inferiori  
Inferiores  
Inférieures

Wurzelheber  
Root Elevators  
Leve per radici  
Elevadores para raíces  
Elevateurs à racines



Eine seite gezahnt  
One side serrated  
Un lato dentellato  
Dentadura màs lado  
Dentelure sur un côté

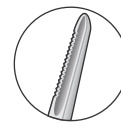
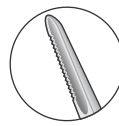


Fig. 94



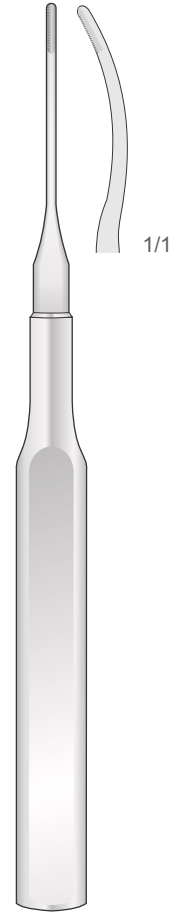
**NMI-DL-76**  
155 mm

Fig. 95



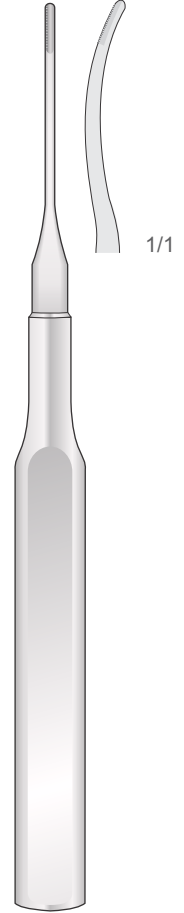
**NMI-DL-77**  
155 mm

Fig. 100L



**NMI-DL-78**  
155 mm

Fig. 100R



**NMI-DL-79**  
155 mm



Wurzelheber  
Root Elevators  
Leve per radici  
Elevadores para raíces  
Elevateurs à racines

Gezahnt  
Serrated  
Dentellate  
Dentadas  
Dentelé

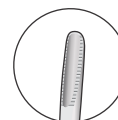
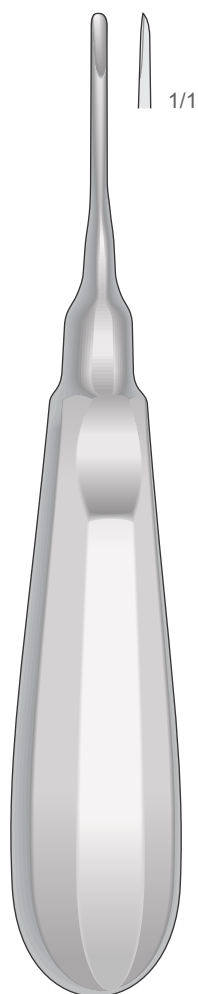
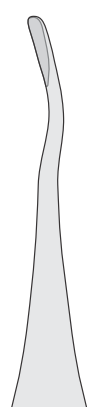


Fig. 301



APEXO  
NMI-DL-34  
160 mm

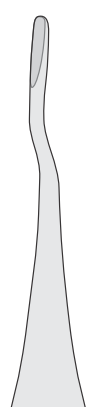
Fig. 302



NMI-DL-35

APEXO  
NMI-DL-35/NMI-DL-36  
160 mm

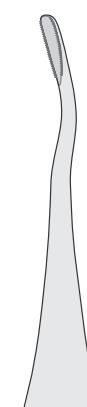
Fig. 303



NMI-DL-36

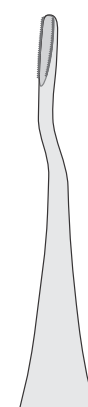
APEXO  
NMI-DL-37/NMI-DL-38  
160 mm

Fig. 77L



NMI-DL-37

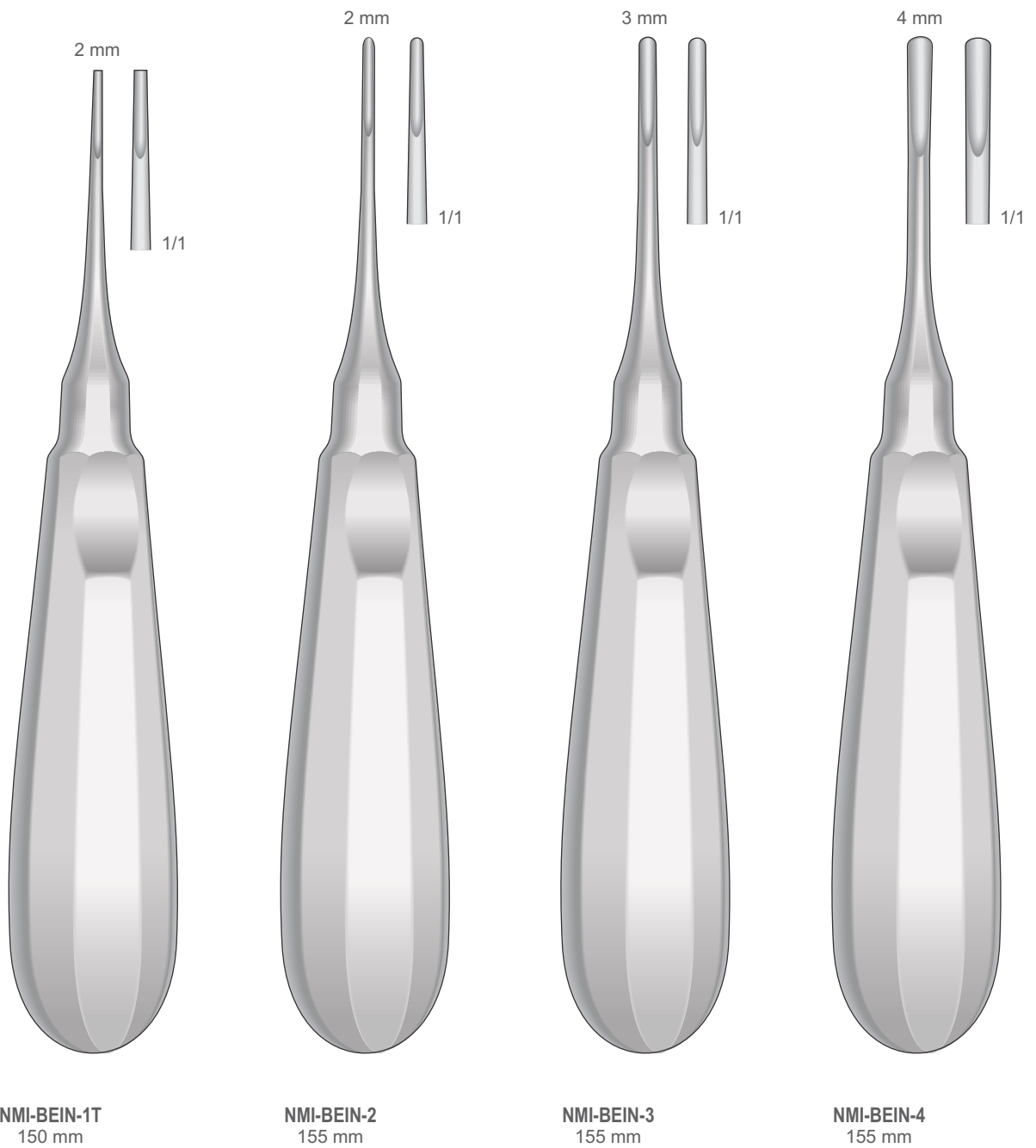
Fig. 77R



NMI-DL-38

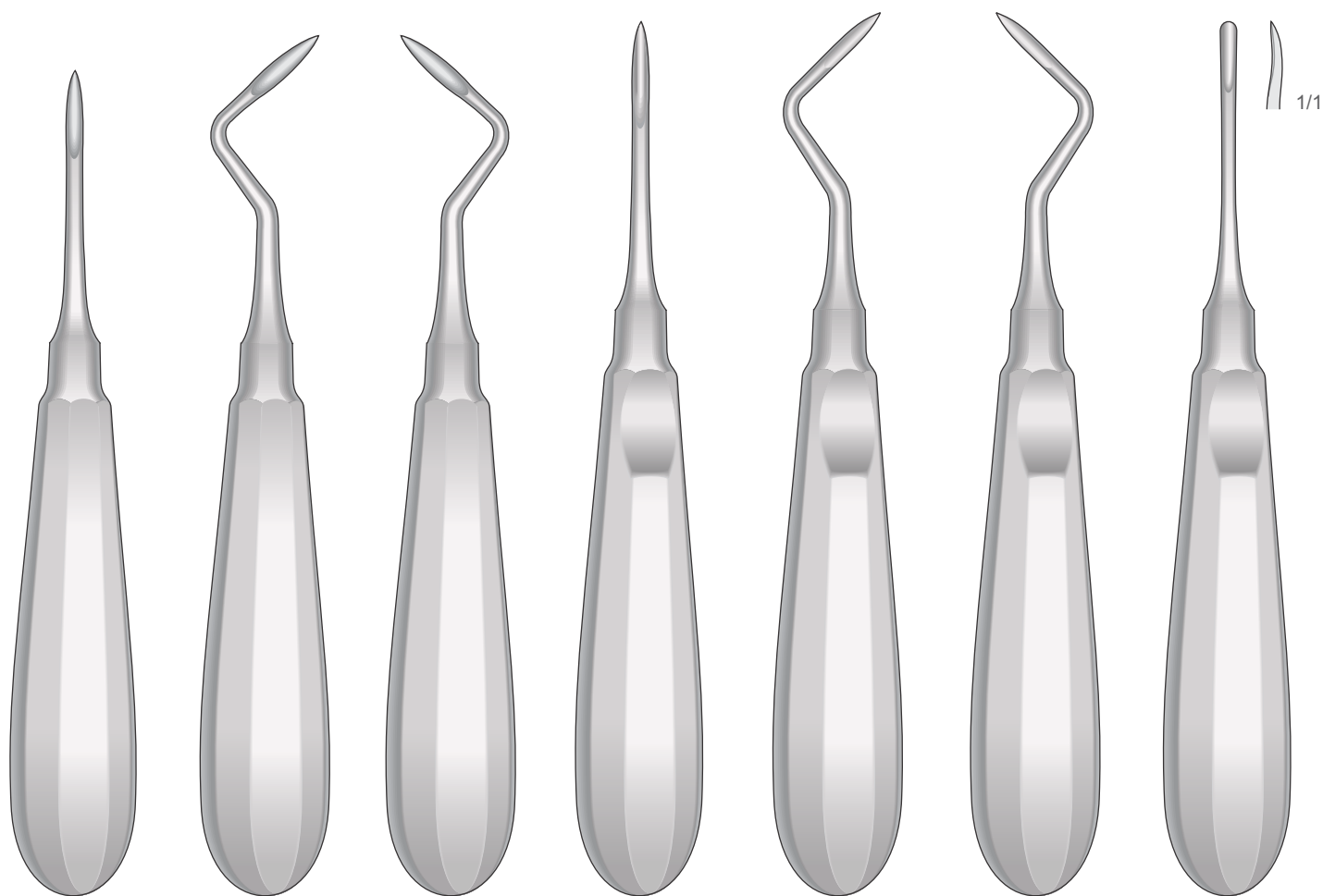


Wurzelheber  
Root Elevators  
Leve per radici  
Elevadores para raíces  
Elevateurs à racines





Wurzelheber  
Root Elevators  
Leve per radici  
Elevadores para raíces  
Elevateurs à racines



**NMI-FLOHR-1**  
140 mm

**NMI-FLOHR-2**  
150 mm

**NMI-FLOHR-3**  
150 mm

**NMI-APICAL-1**  
155 mm

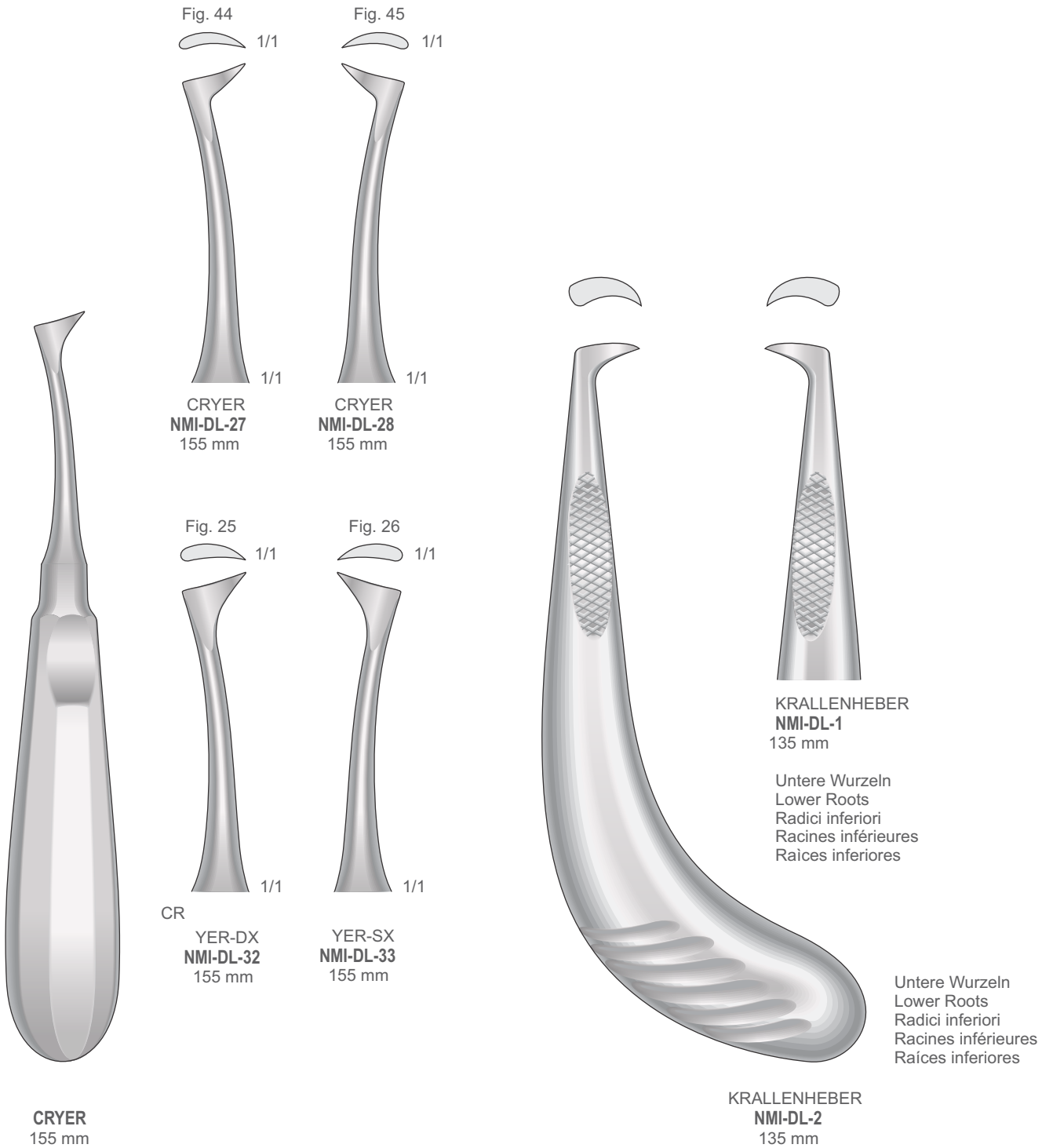
**NMI-APICAL-2**  
155 mm

**NMI-APICAL-3**  
155 mm

**NMI-APICAL-4**  
155 mm

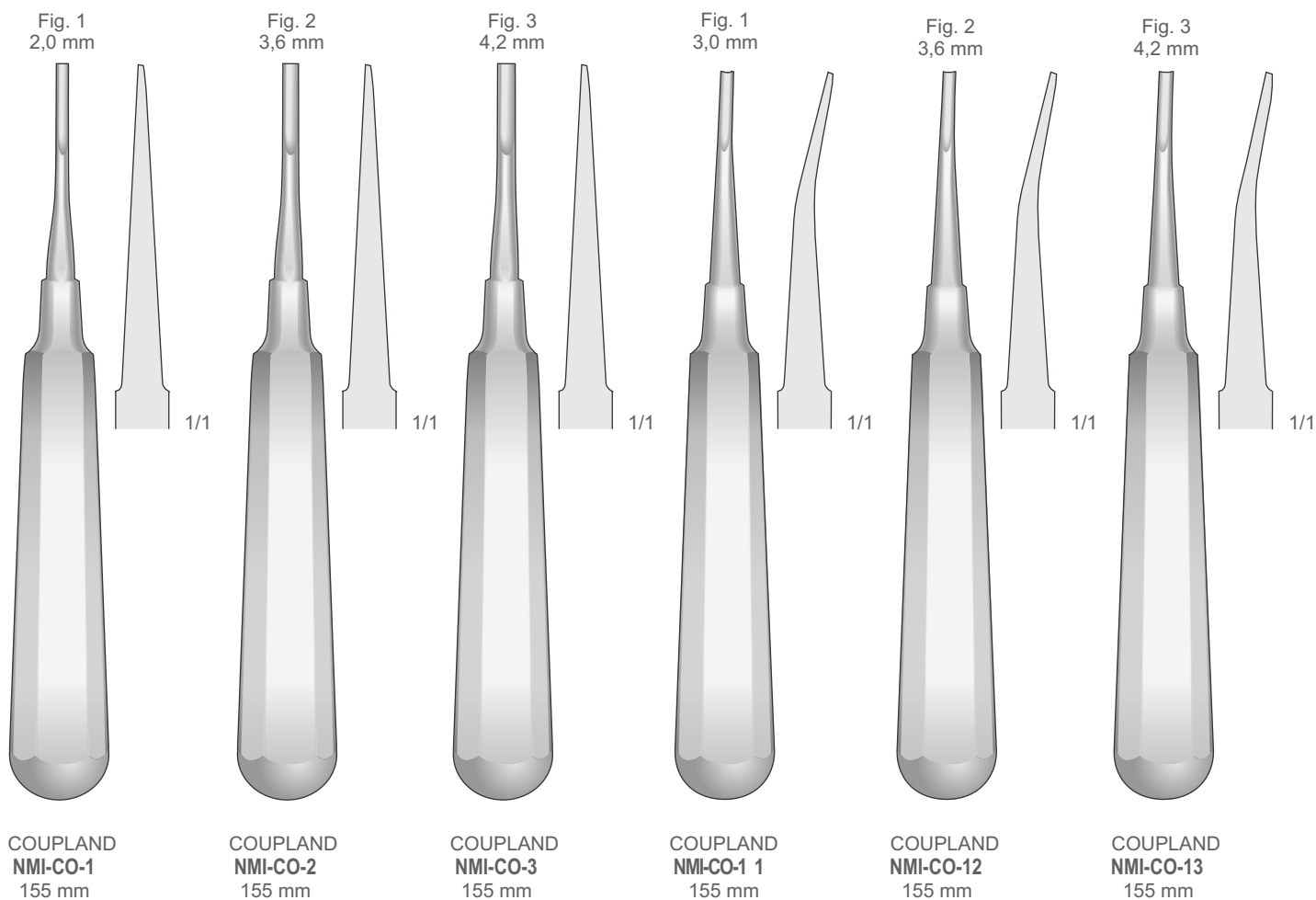
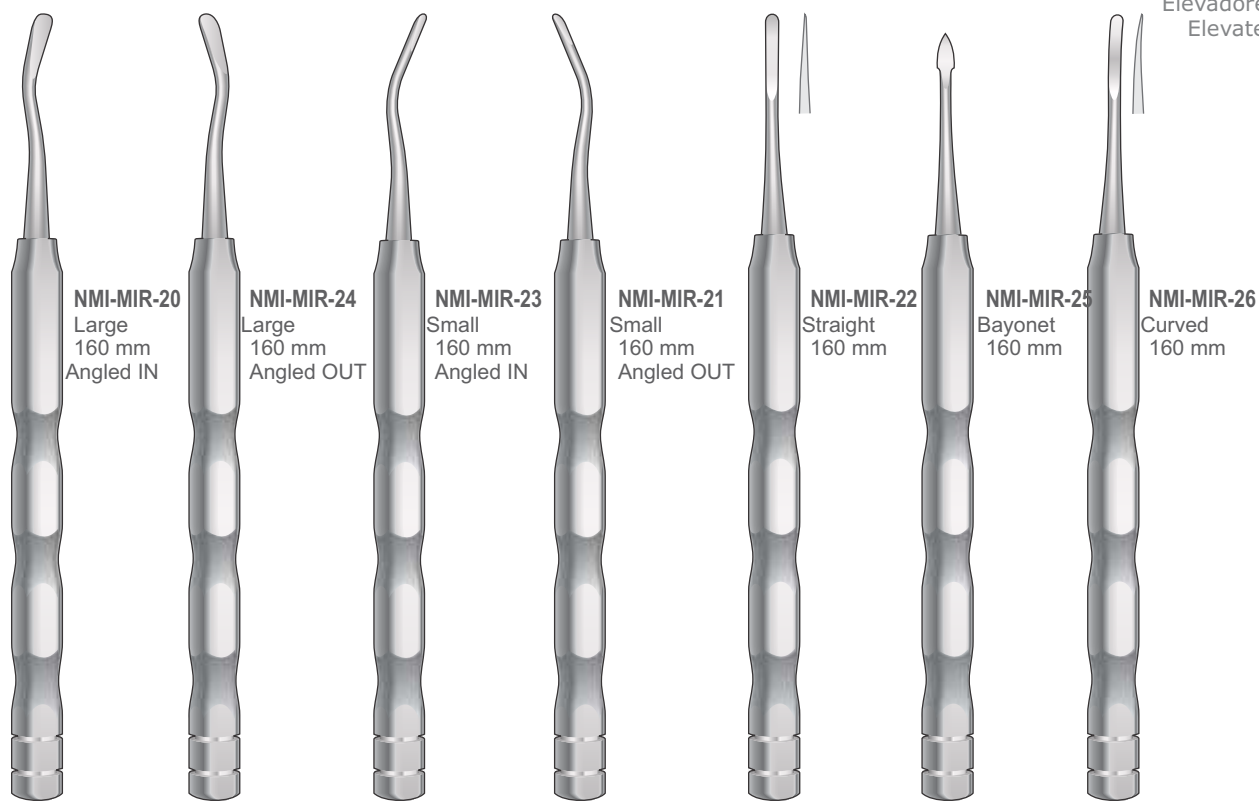


Wurzelheber  
Root Elevators  
Leve per radici  
Elevadores para raíces  
Elevateurs à racines



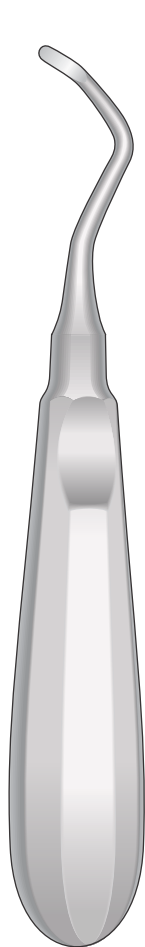


Wurzelheber  
Root Elevators  
Leve per radici  
Elevadores para raíces  
Elevateurs à racines

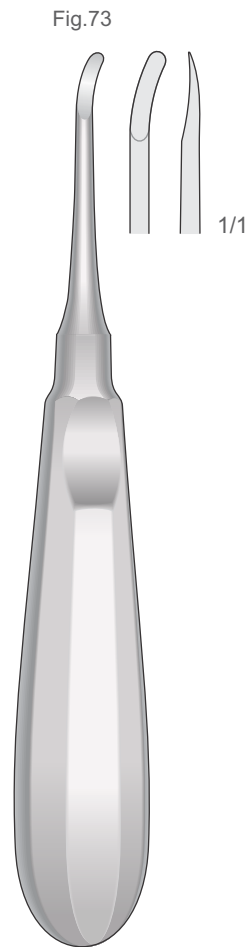
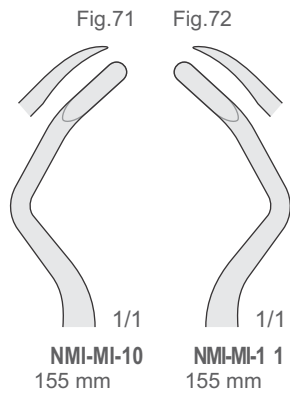




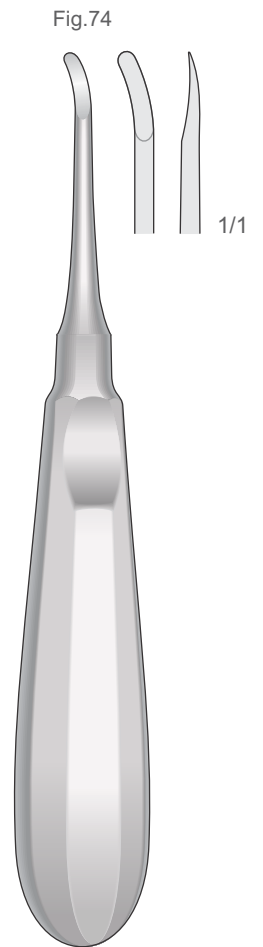
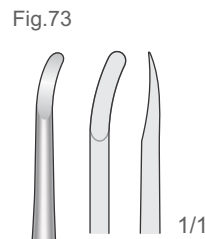
Wurzelheber  
Root Elevators  
Leve per radici  
Elevadores para raíces  
Elevateurs à racines



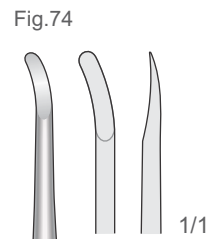
MILLER-APEXO  
NMI-MI-10/ NMI-MI-1 1  
155 mm



MILLER-APEXO  
NMI-MI-12  
155 mm



MILLER-APEXO  
NMI-MI-13  
155 mm





Wurzelheber  
Root Elevators  
Leve per radici  
Elevadores para raíces  
Elevateurs à racines

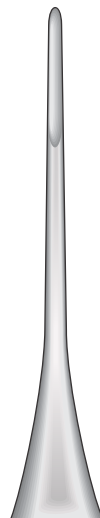
4 mm



1/1

HYLIN  
NMI-DL-1 1  
145 mm

2 mm



1/1

HYLIN-2C  
NMI-DL-13  
145 mm

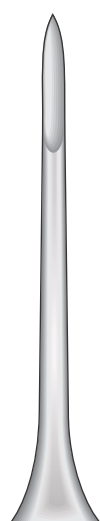
3 mm



1/1

HYLIN-3C  
NMI-DL-14  
145 mm

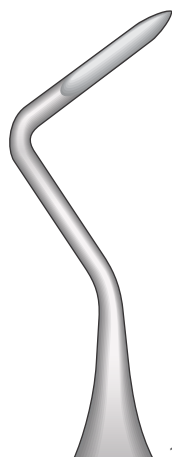
3 mm



1/1

HYLIN-1  
NMI-DL-17  
145 mm

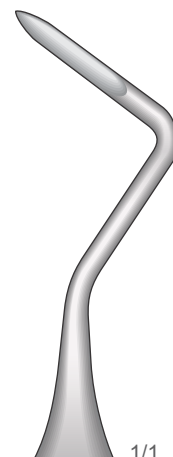
3 mm



1/1

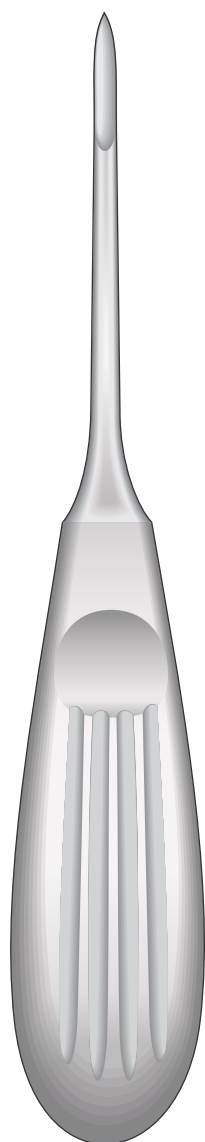
HYLIN-2  
NMI-DL-18  
145 mm

3 mm



1/1

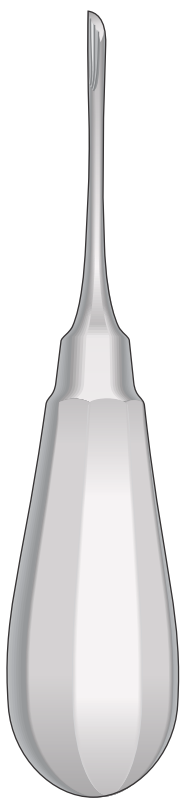
HYLIN-3  
NMI-DL-19  
145 mm



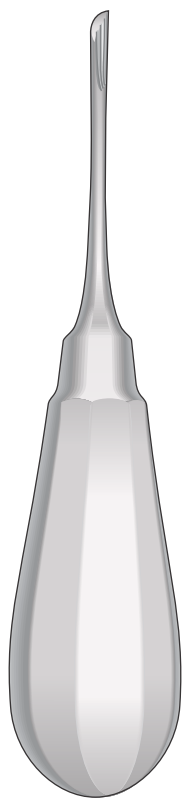
HYLIN  
NMI-DL-1 1/NMI-DL-19  
145 mm



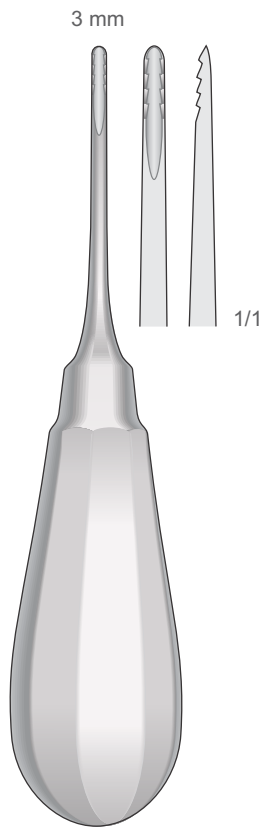
Wurzelheber  
Root Elevators  
Leve per radici  
Elevadores para raíces  
Elevateurs à racines



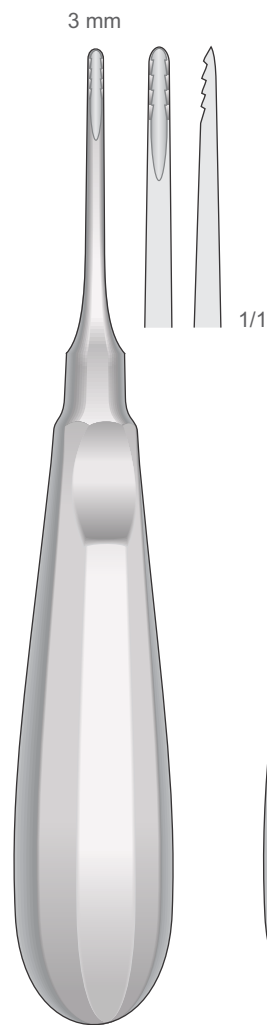
**KOPP**  
**NMI-DL-30**  
130 mm



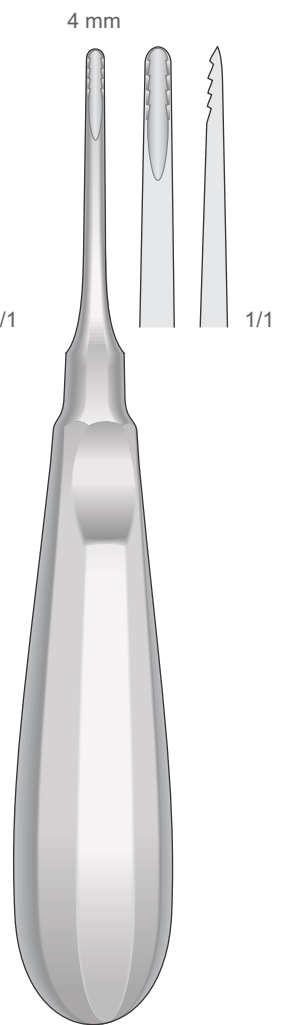
**KOPP**  
**NMI-DL-31**  
130 mm



**NMI-BEIN-1Z**  
130 mm



**NMI-BEIN-2Z**  
155 mm

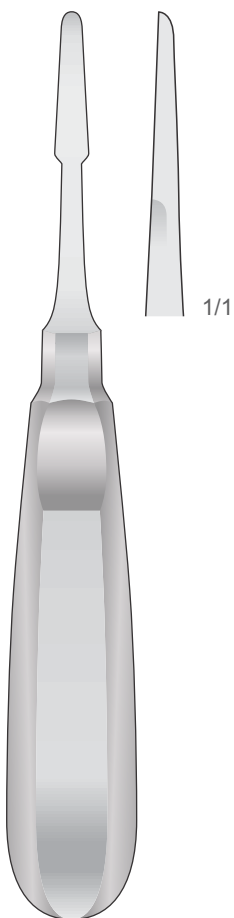


**LINDO-LEVIEN**  
**NMI-BEIN-4Z**  
155 mm



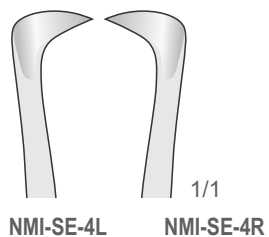
Wurzelheber  
Root Elevators  
Leve per radici  
Elevadores para raíces  
Elevateurs à racines

Fig. 25



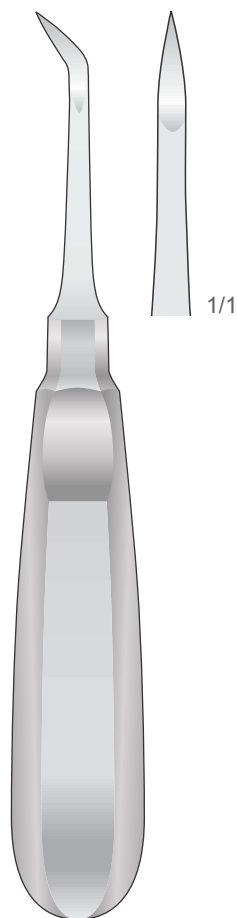
SELDIN  
NMI-SE-2  
160 mm

Fig. 4L Fig. 4R



SELDIN  
NMI-SE-4L/NMI-SE-4R  
160 mm

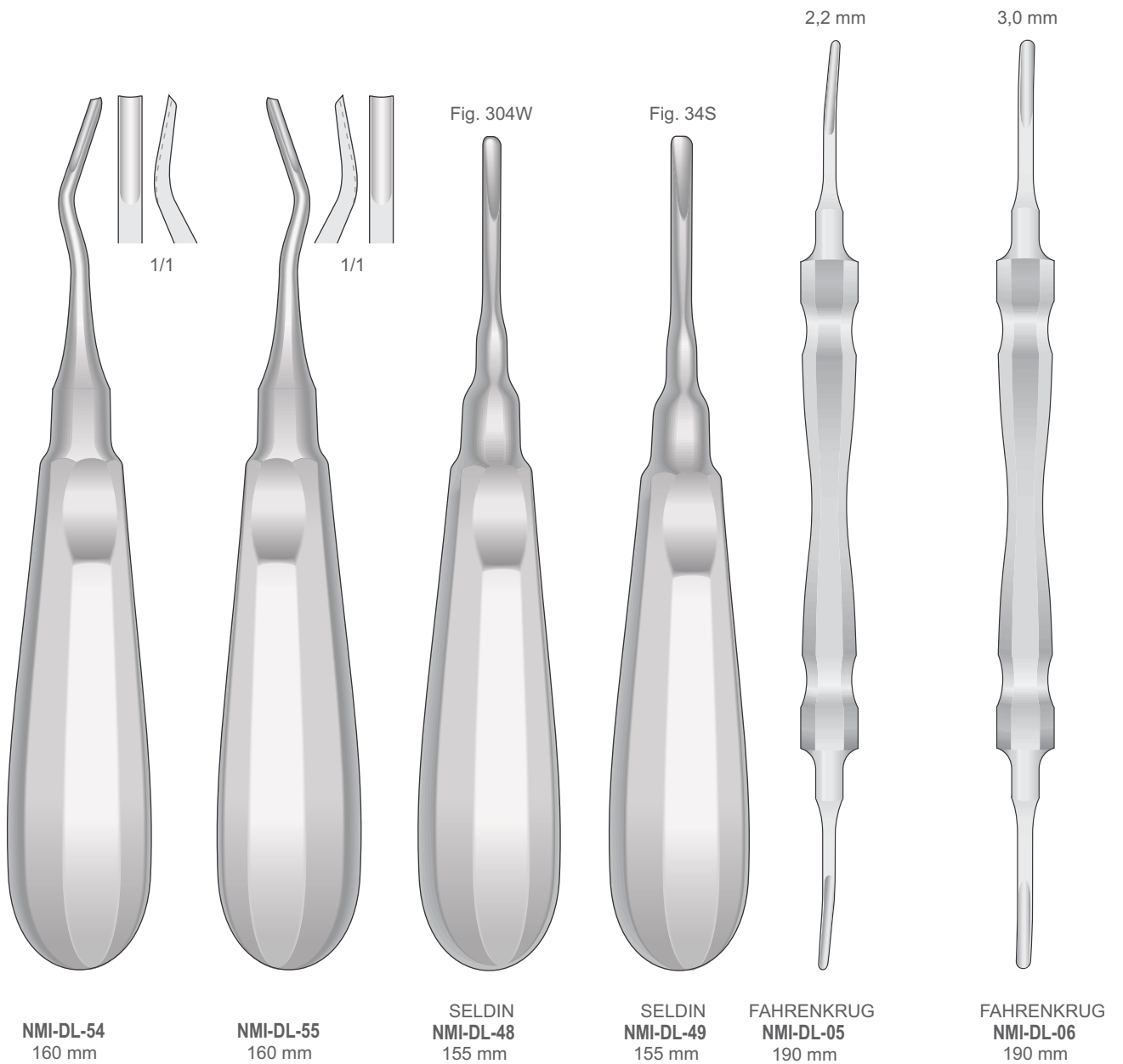
Fig. 8



CRANE PICK  
NMI-HP-6  
155 mm



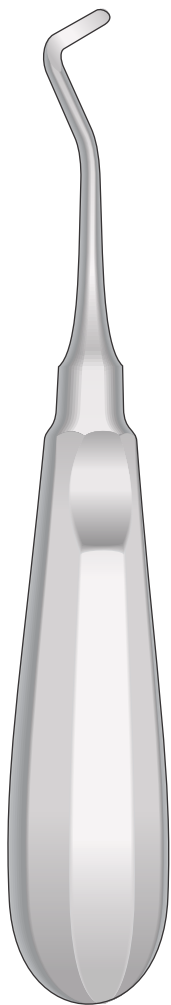
Wurzelheber  
Root Elevators  
Leve per radici  
Elevadores para raíces  
Elevateurs à racines





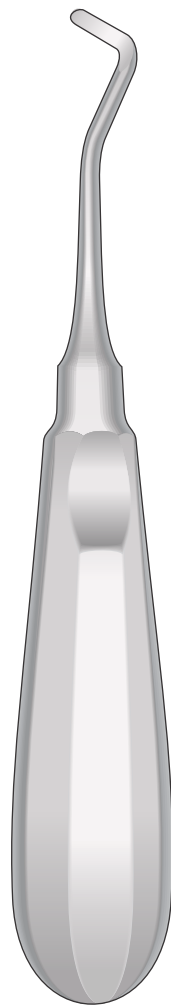
Wurzelheber  
Root Elevators  
Leve per radici  
Elevadores para raíces  
Elevateurs à racines

Fig. 6

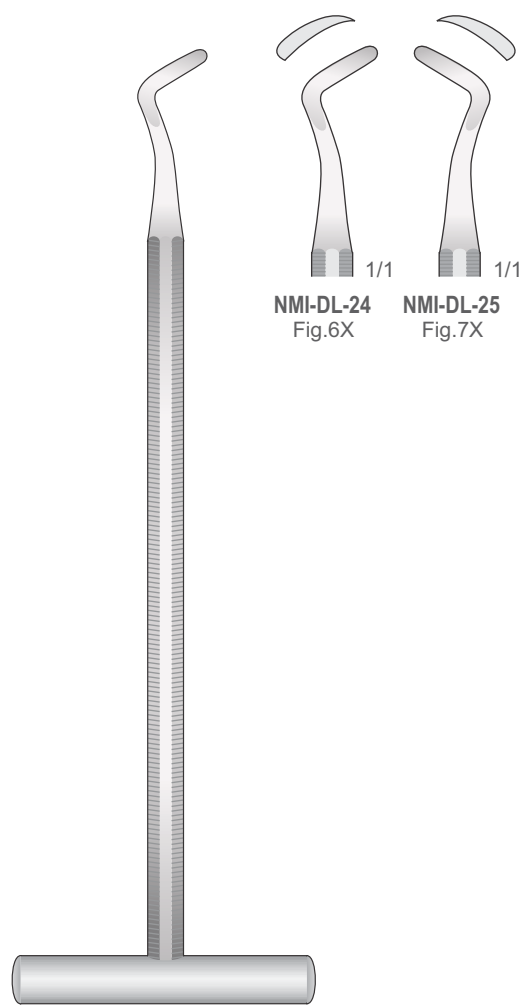


POTT  
NMI-DL-98  
160 mm

Fig. 7



POTT  
NMI-DL-99  
160 mm

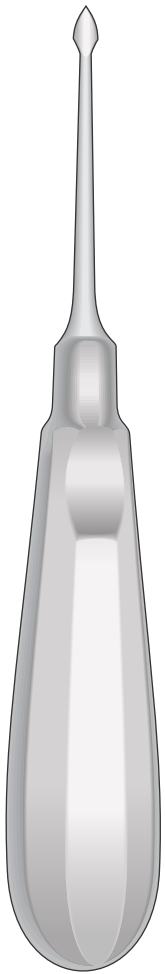


POTT  
NMI-DL-24/NMI-DL-25  
155 mm



Wurzelheber  
Root Elevators  
Leve per radici  
Elevadores para raíces  
Elevateurs à racines

Syndesmotome  
Syndesmotomes  
Sindesmotomi  
Syndesmôtomos  
Syndesmotomes



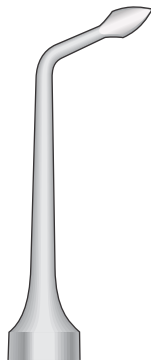
BERNARD  
NMI-DL-73/NMI-DL-124

Gerade  
Straight  
Diritto  
Rectas  
Droites



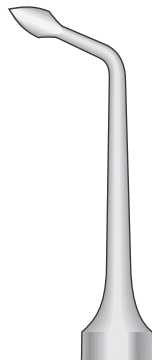
BERNARD  
NMI-DL-73  
150 mm

Links  
Left  
Sinistra  
A la izquierda  
À gauche



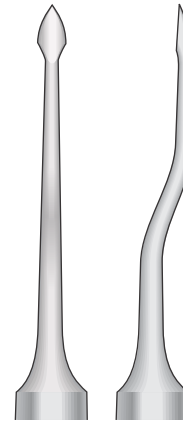
BERNARD  
NMI-DL-74  
140 mm

Rechts  
Right  
Destro  
A la derecha  
À droite

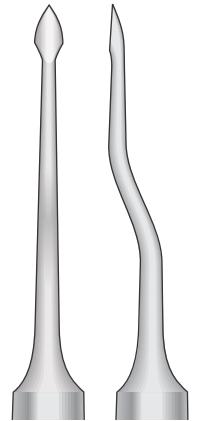


BERNARD  
NMI-DL-75  
140 mm

Bajonett - Bayonet  
Baionetta - Bayoneta  
Baionnette



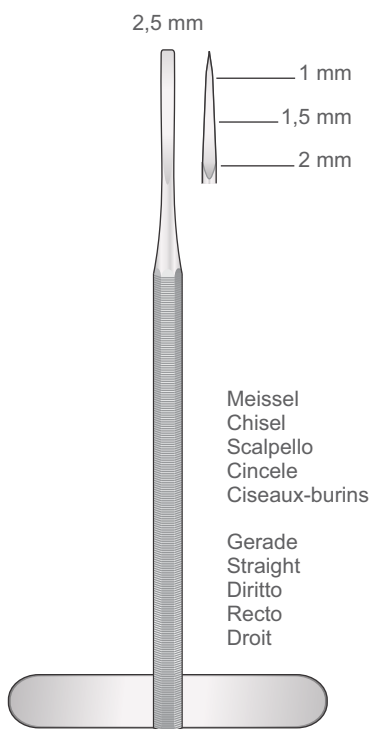
BERNARD  
NMI-DL-123  
150 mm



BERNARD  
NMI-DL-124  
150 mm



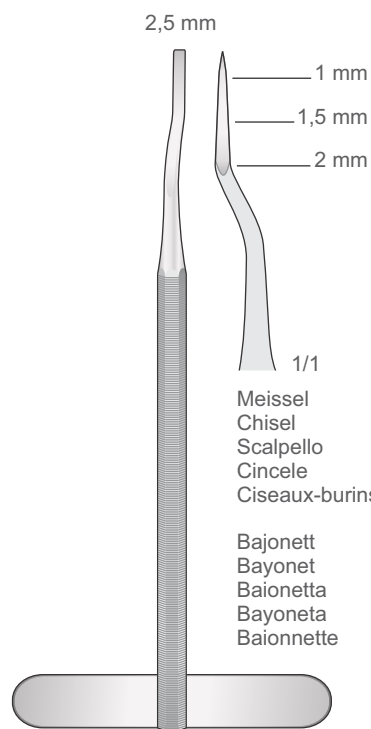
Wurzelheber  
Root Elevators  
Leve per radici  
Elevadores para raíces  
Elevateurs à racines



**NMI-DL-88**  
130 mm

Meissel  
Chisel  
Scalpello  
Cincele  
Ciseaux-burins

Gerade  
Straight  
Diritto  
Recto  
Droit



**NMI-DL-89**  
130 mm

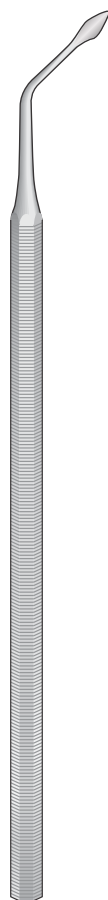
Meissel  
Chisel  
Scalpello  
Cincele  
Ciseaux-burins

Bajonett  
Bayonet  
Baionetta  
Bayoneta  
Baionnette

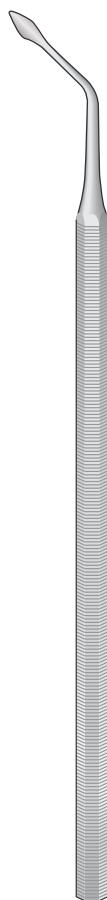
Syndesmotome  
Syndesmotomes  
Sindesmotomo  
Syndesmòtomos  
Syndesmotomes



**NMI-DL-63**  
158 mm



**NMI-DL-62**  
152 mm

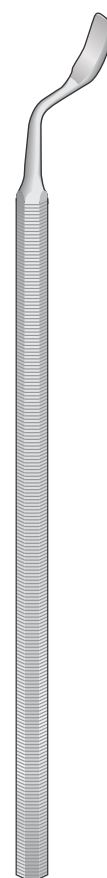


**NMI-DL-61**  
152 mm

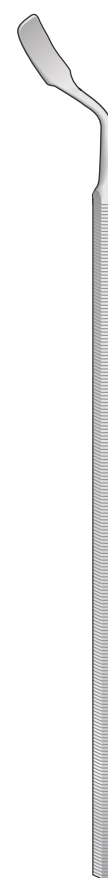
Raspatorien  
Raspatories  
Scollaperiosteo  
Legras  
Rugines



**NMI-DL-59**  
150 mm



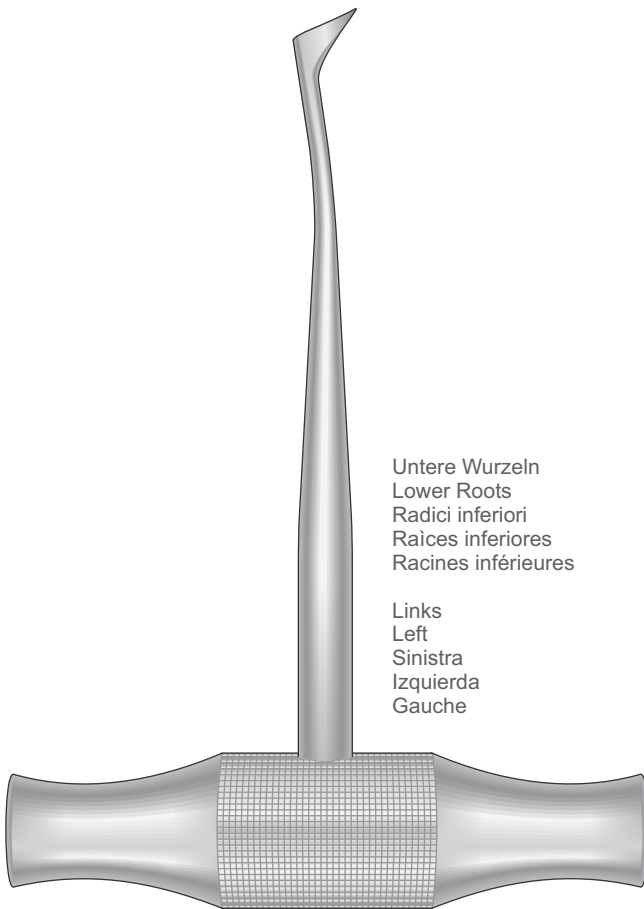
**NMI-DL-68**  
150 mm



**NMI-DL-69**  
150 mm



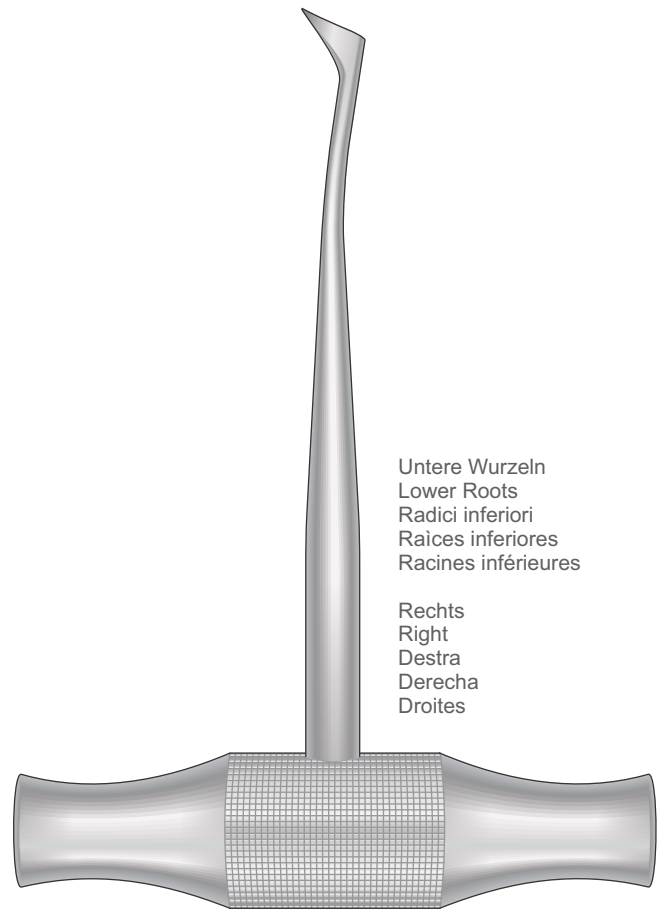
Wurzelheber  
Root Elevators  
Leve per radici  
Elevadores para raíces  
Elevateurs à racines



Untere Wurzeln  
Lower Roots  
Radici inferiori  
Raíces inferiores  
Racines inférieures

Links  
Left  
Sinistra  
Izquierda  
Gauche

WINTER  
NMI-DL-100  
Fig.1



Untere Wurzeln  
Lower Roots  
Radici inferiori  
Raíces inferiores  
Racines inférieures

Rechts  
Right  
Destra  
Derecha  
Droites

WINTER  
NMI-DL-101  
Fig.2



Wurzelheber  
Root Elevators  
Leve per radici  
Elevadores para raíces  
Elevateurs à racines

Fig. 1L



WINTER  
NMI-DL-64  
120 mm

Fig. 1R



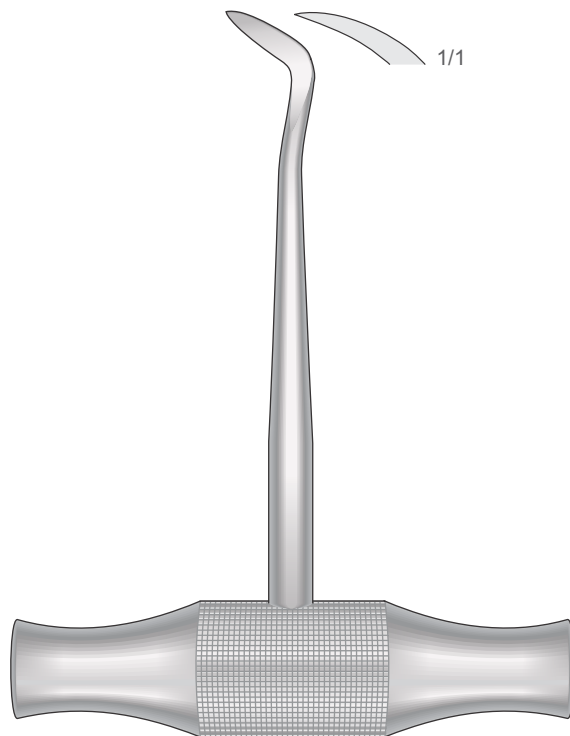
WINTER  
NMI-DL-65  
120 mm

Fig. 14L



WINTER  
NMI-DL-66  
125 mm

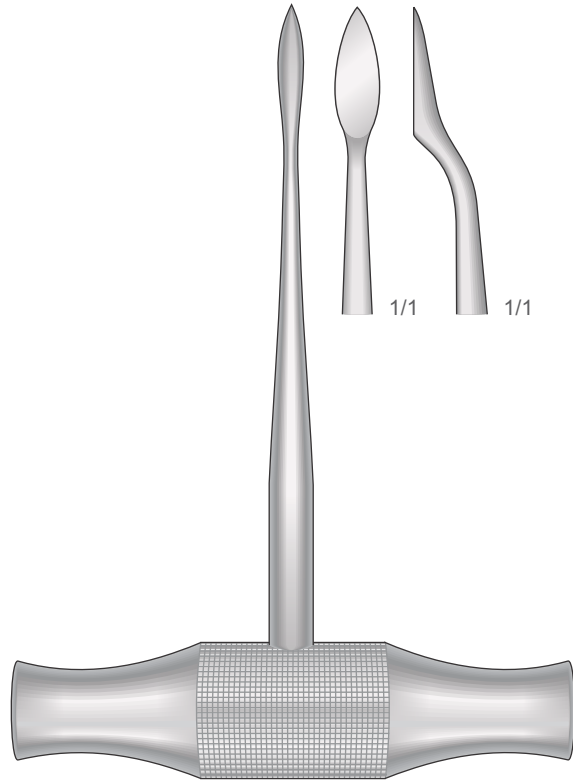
Fig. 14R



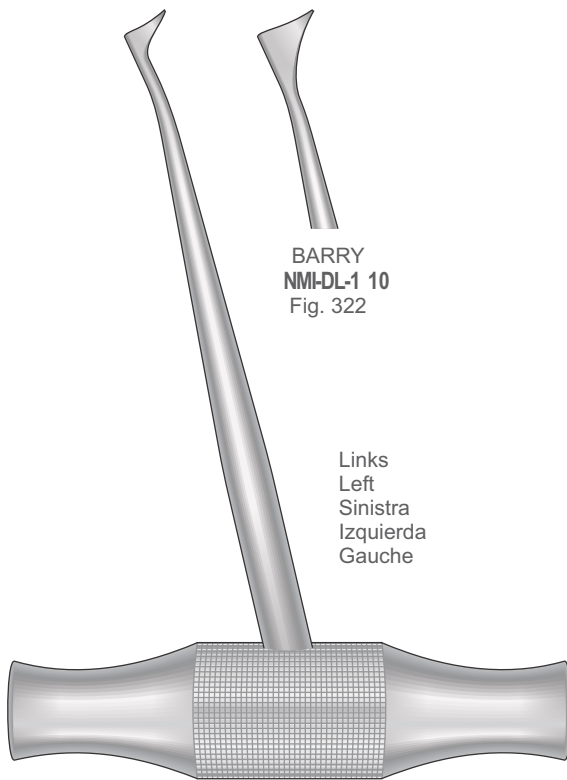
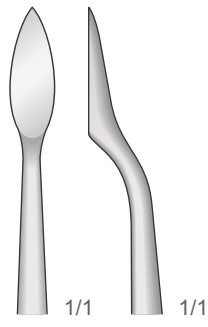
WINTER  
NMI-DL-67  
125 mm



Wurzelheber  
Root Elevators  
Leve per radici  
Elevadores para raíces  
Elevateurs à racines



LECLUSE  
NMI-DL-90  
130 mm

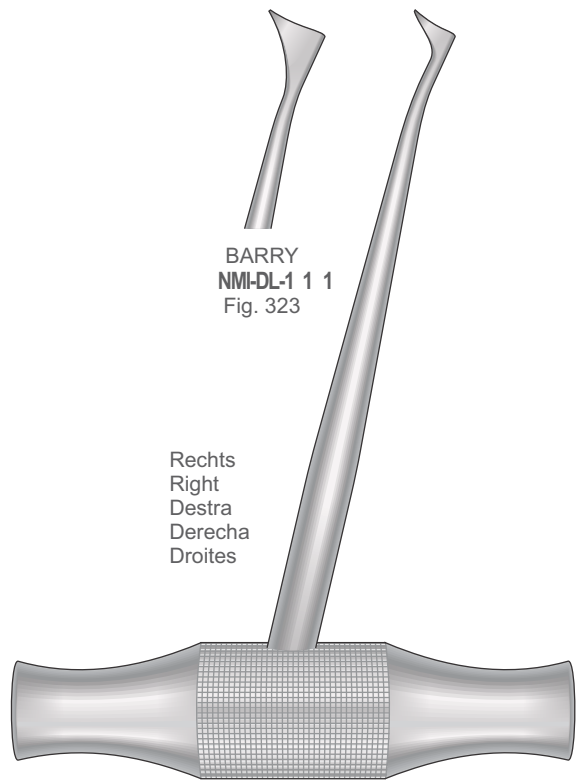


BARRY  
NMI-DL-1 10  
Fig. 322

Links  
Left  
Sinistra  
Izquierda  
Gauche

BARRY  
NMI-DL-108 Fig. 320  
1

15 mm



BARRY  
NMI-DL-1 1 1  
Fig. 323

Rechts  
Right  
Destra  
Derecha  
Droites

BARRY  
NMI-DL-109 Fig. 321  
1

15 mm



Wurzelheber  
Root Elevators  
Leve per radici  
Elevadores para raíces  
Elevateurs à racines

3 mm



**NMI-LA-1**  
160 mm

3 mm



**NMI-LA-2**  
160 mm

4 mm



**NMI-LA-3**  
160 mm

4 mm



**NMI-LA-4**  
160 mm

4,5 mm



**NMI-LA-5**  
160 mm

4,5 mm



**NMI-LA-6**  
160 mm



Wurzelheber  
Root Elevators  
Leve per radici  
Elevadores para raíces  
Elevateurs à racines



**NMI-LA-7**  
160 mm



**NMI-LA-8**  
160 mm



**NMI-LA-9**  
160 mm



**NMI-LA-10**  
160 mm



Wurzelheber  
Root Elevators  
Leve per radici  
Elevadores para raíces  
Elevateurs à racines

2 mm



**NMI-LA-11**  
155 mm

3 mm



**NMI-LA-12**  
155 mm

4 mm



**NMI-LA-13**  
155 mm



**NMI-LA-16**  
160 mm



**NMI-LA-17**  
160 mm



Wurzelheber  
Root Elevators  
Leve per radici  
Elevadores para raíces  
Elevateurs à racines



**NMI-LA-20**  
160 mm



**NMI-LA-21**  
160 mm



**NMI-LA-22**  
160 mm



**NMI-LA-23**  
160 mm



Syndesmotome  
Syndesmotomes  
Sindesmotomo  
Syndesmòtomos  
Syndesmotomes



Massiv  
Solid  
Manico  
Pieno  
Massif

**CHOMPRET  
NMI-CH-1**  
150 mm



Massiv  
Solid  
Manico  
Pieno  
Massif

**CHOMPRET  
NMI-CH-12**  
150 mm



Massiv  
Solid  
Manico  
Pieno  
Massif

**CHOMPRET  
NMI-CH-13**  
150 mm



Massiv  
Solid  
Manico  
Pieno  
Massif

**CHOMPRET  
NMI-CH-14**  
145 mm



**CHOMPRET  
NMI-CH-1**  
165 mm



**CHOMPRET  
NMI-CH-2**  
165 mm



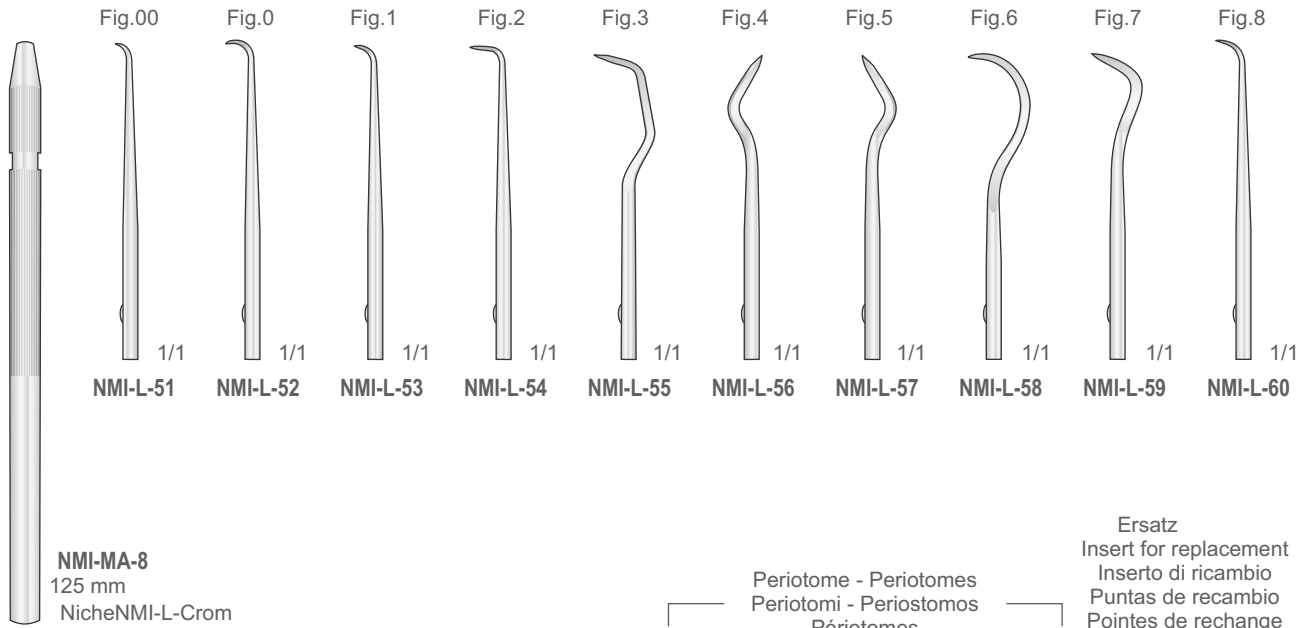
**CHOMPRET  
NMI-CH-3**  
165 mm



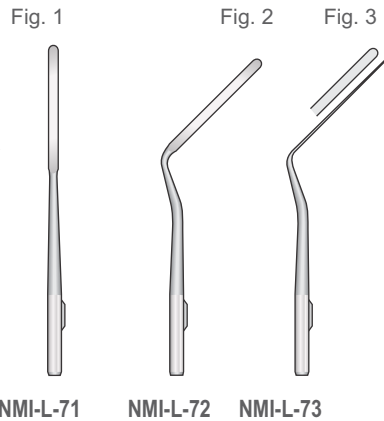
**CHOMPRET  
NMI-CH-4**  
160 mm



## MORSE - SCALERS



Periotome - Periotomes  
 Periotomi - Periotomos  
 Périotomes

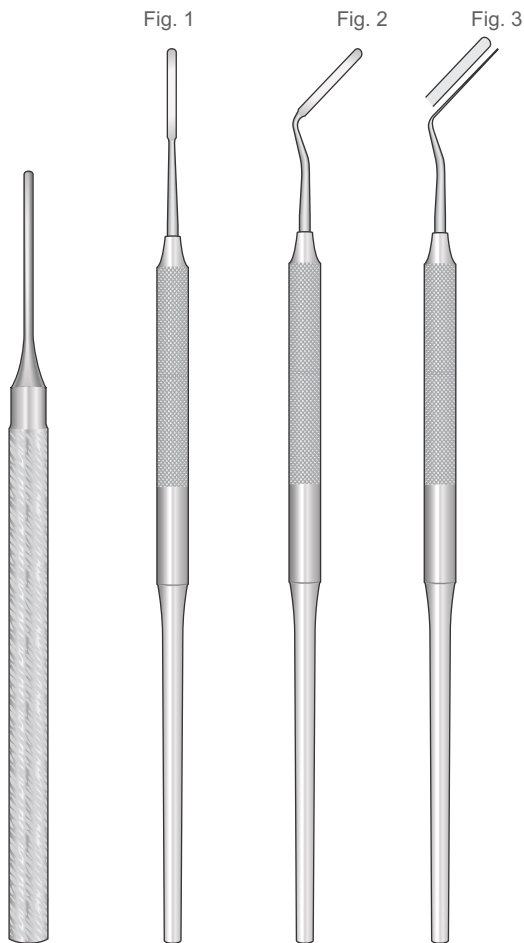


Ersatz  
 Insert for replacement  
 Inserto di ricambio  
 Puntas de recambio  
 Pointes de rechange

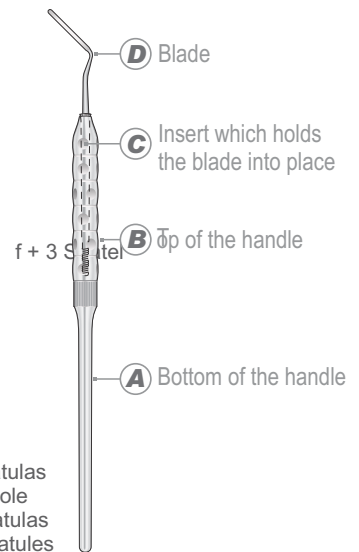
Für / For  
 Per / Para / Pour  
**NMI-MA-9**



**NMI-MA-9R**  
 48 mm



**NMI-MA-9**  
 Handle  
 140 mm  
 Rostfrei  
 Stainless Steel  
 Inox



**NMI-MC-70**  
 (NMI-MA-9 + NMI-L-71,  
 NMI-L-72, NMI-L-73)  
 Komplet mit 1 Griff  
 Complete with 1 Handle + 3 Spatulas  
 Completo di 1 Manico + 3 Spatole  
 Completo con 1 mango + 3 Espátulas  
 Complete avec 1 Manche + 3 Spatules



Syndesmotome  
Syndesmotomes  
Sindesmotomi  
Syndesmótomos  
Syndesmotomes

**NMI-SDM-C**

Komplett mit 2 Griff  
Complete with 2 Handles + 20 Blades  
Completo di 2 Manici + 20 lame  
Completo con 2 mangos + 20 hojas  
Complete avec 2 Manches + 20 lames

**NMI-SD-M**

Grif  
Handle  
Manico  
Mango  
Manche

**NMI-SDM-9**

e + 9 Klängen APICALI

Komplett mit 2 Griff  
Complete with 2 Handles + 9 Blades APICALI  
Completo di 2 Manici + 9 lame APICALI  
Completo con 2 mangos + 9 hojas APICALI  
Complete avec 2 Manches + 9 lames APICALI

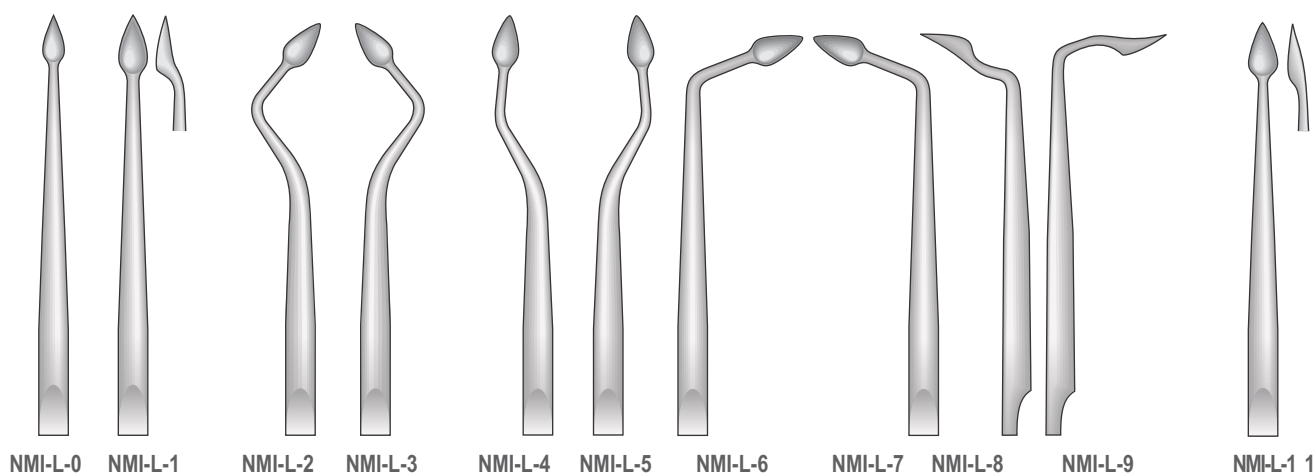
**NMI-SDM-11**

e + 11 Klängen CERVICALI

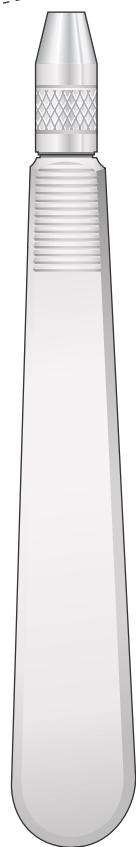
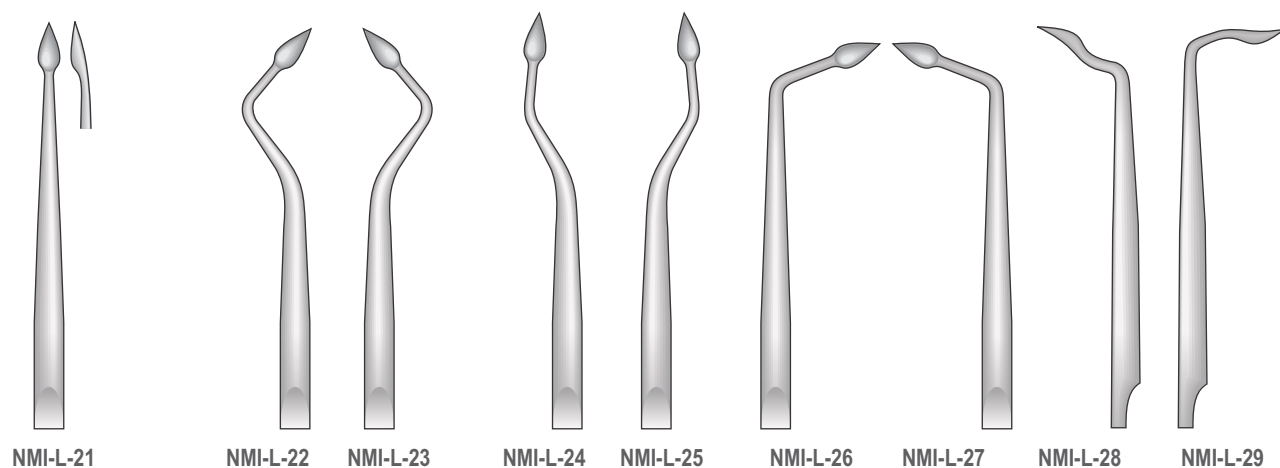
Komplett mit 2 Griff  
Complete with 2 Handles + 11 Blades CERVICALI  
Completo di 2 Manici + 11 lame CERVICALI  
Completo con 2 mangos + 11 hojas CERVICALI  
Complete avec 2 Manches + 11 lames CERVICALI

f

Lame CERVICALI



Lame APICALI



NMI-SD-M

# DENTAL Instruments

Extracting Forceps

Root Elevators

Scalpel Blades and Handles

Surgical Scissors

Tissue and Dressing Forceps

Needle Holders

Hemostatic Forceps | Towel Clamps

Retractors | Mouth Gags

Implantology

Periosteal | Curettes | Rongeurs

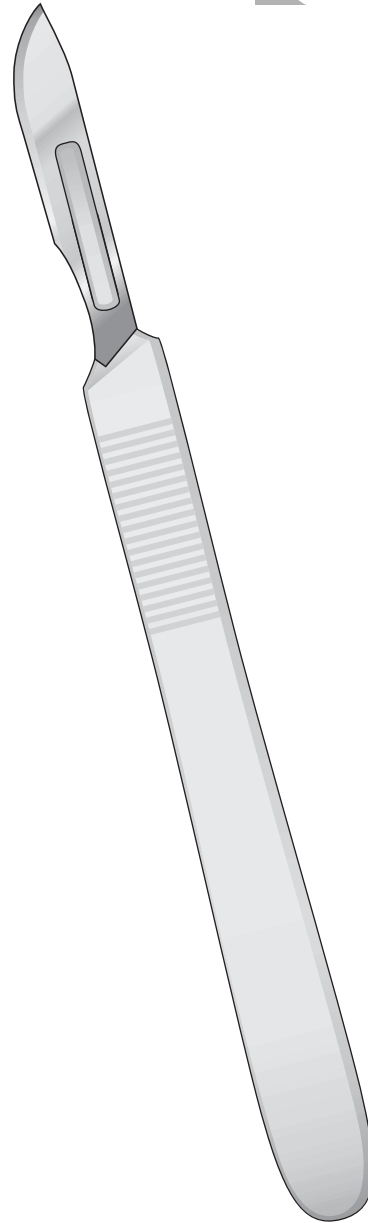
Dental Restoration | Periodontology

Suction Tube

Orthodontics

Crown Instruments | Laboratory

Instrument Maintenance | Sterilization



75-81

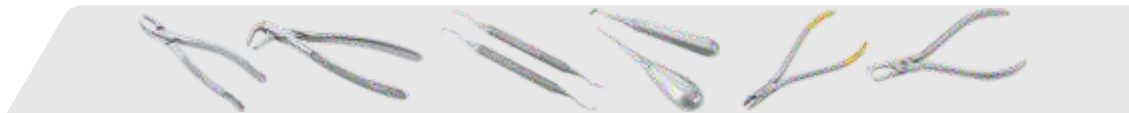
**Scalpel Blades and Handles**

Skalpellklingen und Skalpellgriffe

Lames et manches de bistouri

Hojas y mangos de bisturí

Lame e manici per bisturi



Skalpelli - Mikro Skalpellklingen  
Scalpel Handles - Micro Scalpel Blades  
Manici per bisturi - Micro lame per bisturi  
Mangos de bisturi - Micro hojas de bisturi  
Manches pour bistouris - Micro lames de bistouri

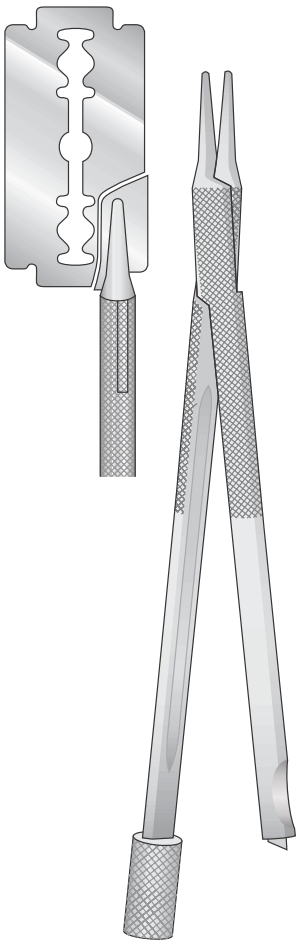


**NMI-LB-40**  
Packung 10 Klingen  
Package 10 blades  
Scatola da 10 lame  
Cajita de 10 hojas  
Boite de 10 lames

Skalpelli für Mikro-Klingen  
Scalpel handles for Micro blades  
Manici per micro lame  
Mangos de bisturi para micro hojas  
Manches de bistouris pour micro lames

Micro-Klingen  
Micro blades  
Micro lame  
Micro hojas  
Micro lames

Rasierklingen-Brecker und halter  
Razor blade breaker and holder  
Manico porta lame  
Mango para Hojas de afeitar  
Porte lames à rasoir



**NMI-NK-12**  
120 mm



**NMI-BB-46**  
135 mm



**NMI-BB-48**  
155 mm



**NMI-LB-361**  
Conf. 10 pz.



**NMI-LB-362**  
Conf. 10 pz.



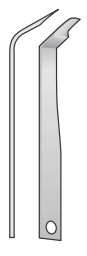
**NMI-LB-363**  
Conf. 1 pz.



**NMI-LB-364**  
Conf. 10 pz.



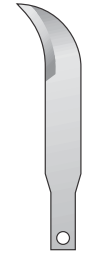
**NMI-LB-365**  
Conf. 10 pz.



**NMI-LB-366**  
Conf. 1 pz.



**NMI-LB-367**  
Conf. 10 pz.



**NMI-LB-368**  
Conf. 10 pz.

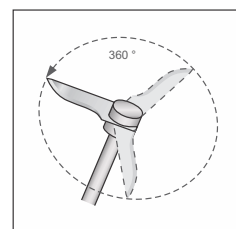


**NMI-LB-369**  
Conf. 1 pz.



Skalpellgriffe  
Scalpel Handles  
Manici porta lame  
Mangos de bisturí  
Manches de bistouri

Für Mikro-Klingen  
For Micro Blades  
Per micro lame  
Para micro Hojas  
Pour Micro-Lame de bistouris



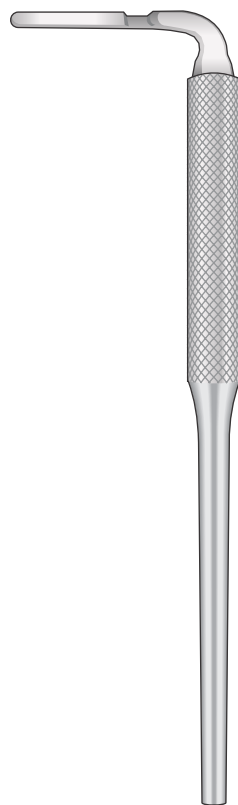
**NMI-NK-1**  
100 mm



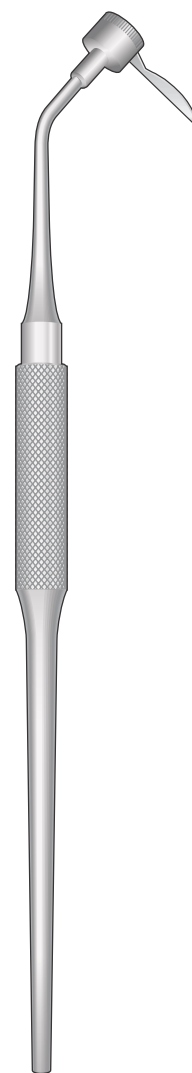
**NMI-NK-3**  
130 mm



**NMI-NK-2**  
150 mm



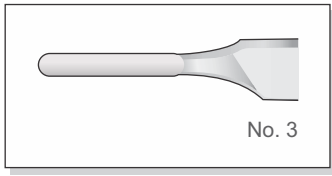
**NMI-MA-B16**  
120 mm



**NMI-GB-4**  
165 mm



Skalpelle und Skalpellegriffe  
Scalpel Blades and Handle  
Lame e manici per bisturi  
Hojas y mangos de bisturí  
Lames et manches de bistouri



Packungen à 100  
Packages of 100 ea  
Scatole da 100 pezzi  
Cajas de 100 c/u  
Boîtes de 100 pièces



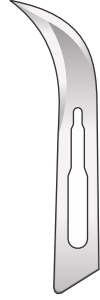
**NMI-LB-10**  
Fig. 10



**NMI-LB-1 1**  
Fig. 1



**NMI-LB-12**  
Fig. 12



**NMI-LB-12D**  
Fig. 12D



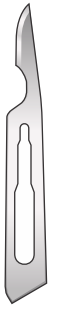
**NMI-LB-13**  
Fig. 13



**NMI-LB-15**  
Fig. 15



**NMI-LB-15A**  
Fig. 15A



**NMI-LB-15C**  
Fig. 15C



**NMI-MA-B3**



**NMI-MA-B3M**  
Fig. 3M



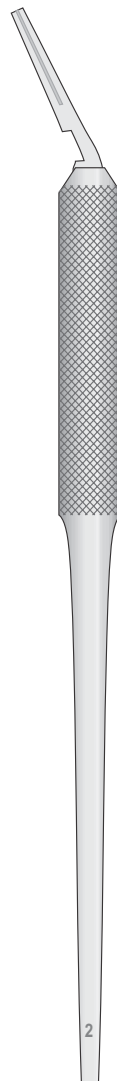
**NMI-MA-B7**



**NMI-MA-B7K**



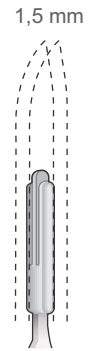
**NMI-MA-B1**  
Fig. 5



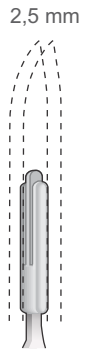
**NMI-MA-B2**  
Fig. 5A



**NMI-MA-B8/NMI-MA-B9**  
155 mm



**NMI-MA-B8**

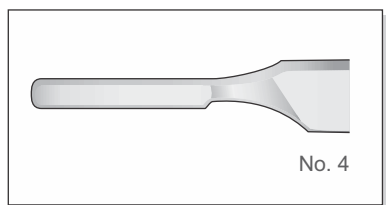


**NMI-MA-B9**

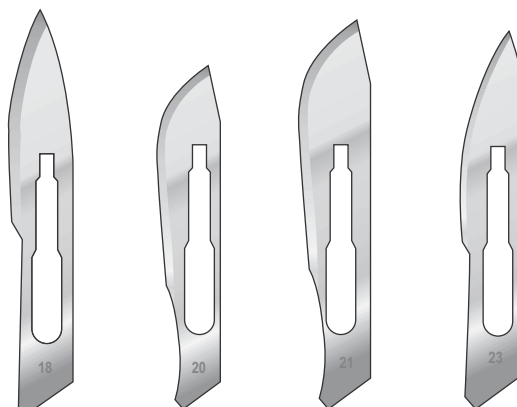
Doppelt Skalpellegriff  
Scalpel Handle double Blade  
Manico per bisturi a doppia lama  
Mango de bisturí doble hojas  
Manche pour bistouri double-lames



Skalpelle  
Scalpel Blades  
Lame per bisturi  
Hojas de bisturí  
Lames de bistouri



Packungen à 100  
Packages of 100 ea  
Scatole da 100 pezzi  
Cajas de 100 c/u  
Boîtes de 100 pièces

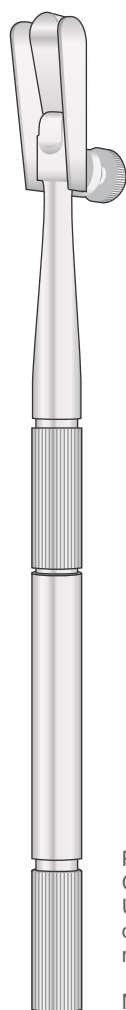


**NMI-LB-18**  
Fig. 18

**NMI-LB-20**  
Fig. 20

**NMI-LB-21**  
Fig. 21

**NMI-LB-23**  
Fig. 23



Palatal, Gingival,  
Connective Tissue Grafts  
Uses standard  
double-edged  
razor blade

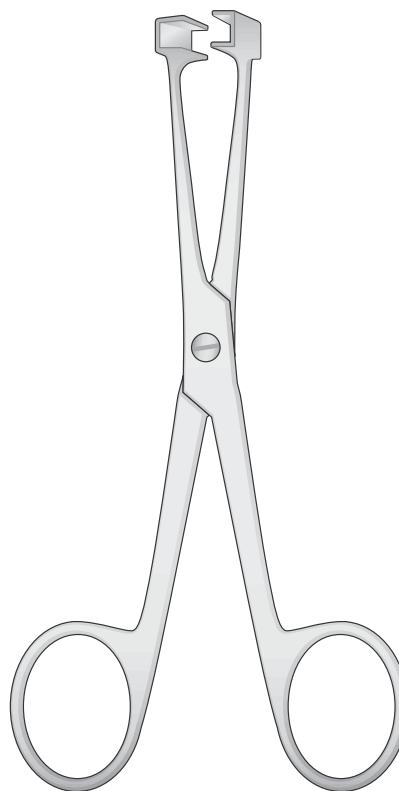
Mucotomo

**PAQUETTE  
BLADE HOLDER  
NMI-GB-2**  
160 mm

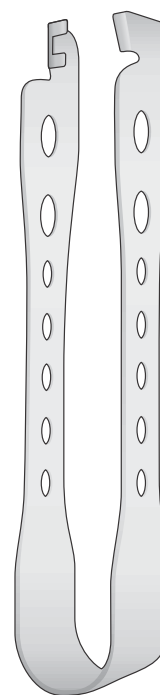


**NMI-MA-B4**  
Fig. 4

Klingenentfemer  
Scalpel blade removing forceps  
Pinze togilama  
Pinza para quitar hojas de bisturías  
Pince pour enlever les lames de bistouris



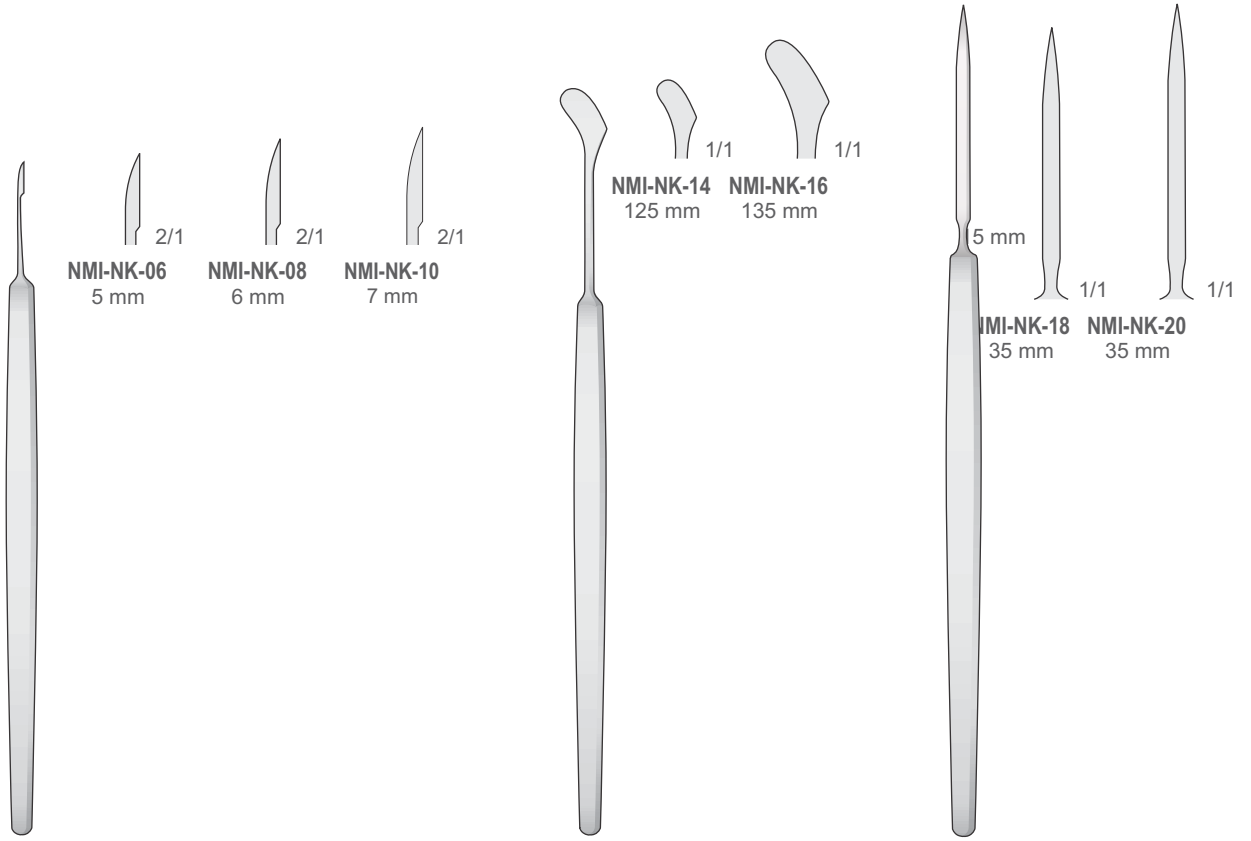
**NMI-GS-18**  
135 mm



**NMI-GS-16** 15 mm  
1



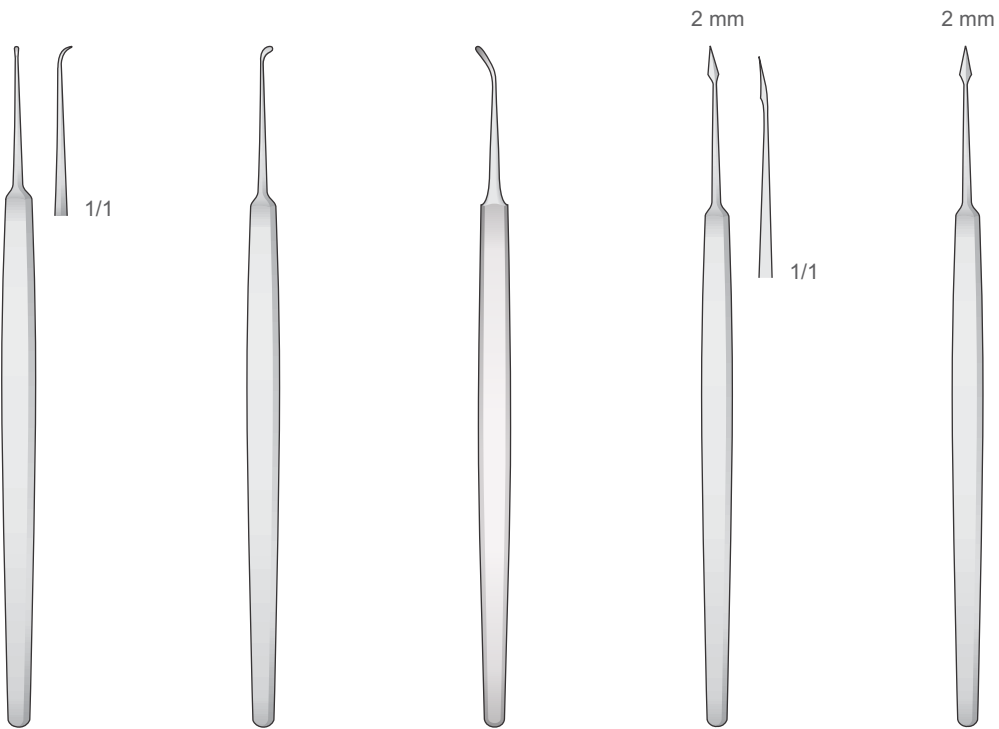
Messer  
Knives  
Coltelli  
Cuchillos  
Couteaux



ZIEGLER  
NMI-NK-06/NMI-NK-10  
1

GRAEFE  
NMI-NK-14/NMI-NK-16

GRAEFE  
NMI-NK-18/NMI-NK-20  
140 mm



LA FORCE  
NMI-NK-07  
120 mm

ELLIS  
NMI-NK-09  
120 mm

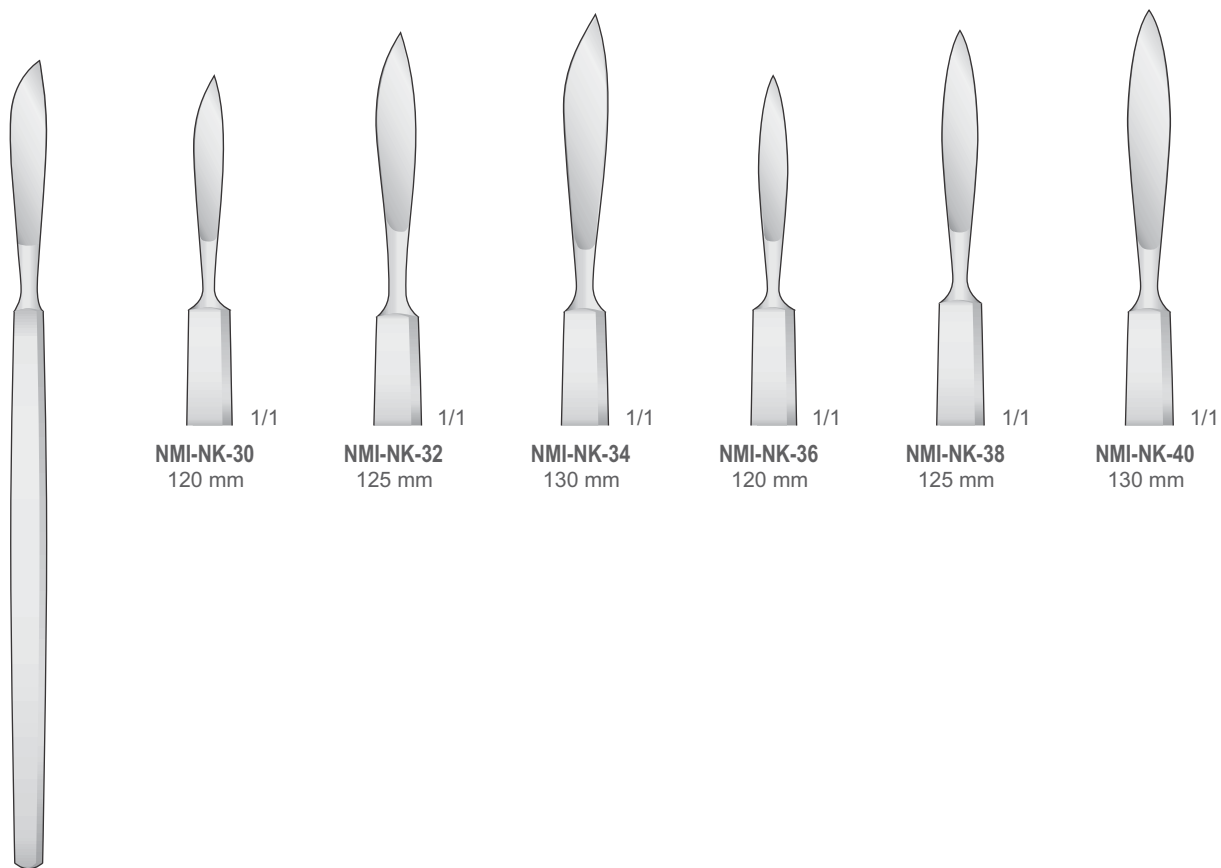
NMI-NK-1  
125 mm

NMI-NK-17  
125 mm

NMI-NK-39  
125 mm



Messer  
Knives  
Coltelli  
Cuchillos  
Couteaux



**NMI-NK-30**  
120 mm

**NMI-NK-32**  
125 mm

**NMI-NK-34**  
130 mm

**NMI-NK-36**  
120 mm

**NMI-NK-38**  
125 mm

**NMI-NK-40**  
130 mm

**NMI-NK-30/NMI-NK-40**

## DENTAL Instruments

Extracting Forceps

Root Elevators

Scalpel Blades and Handles

**Surgical Scissors**

Tissue and Dressing Forceps

Needle Holders

Hemostatic Forceps | Towel Clamps

Retractors | Mouth Gags

**Implantology**

Periosteal | Curettes | Rongeurs

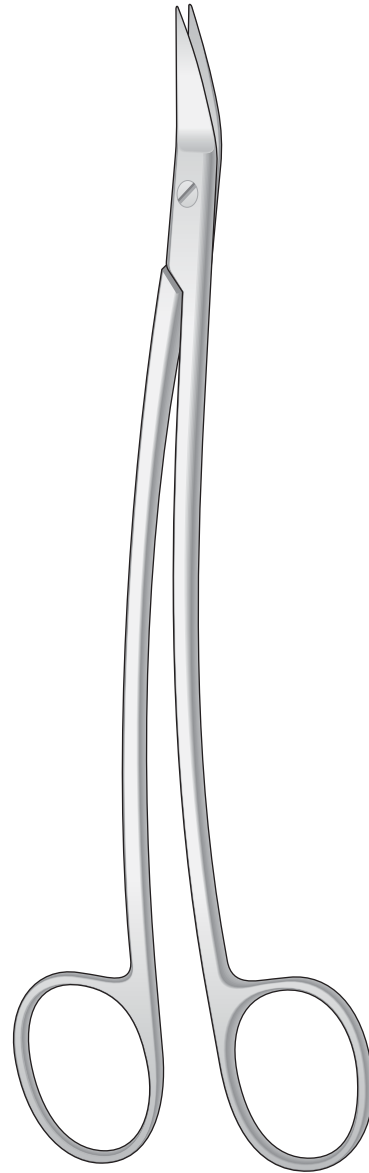
Dental Restoration | Periodontology

**Suction Tube**

Orthodontics

Crown Instruments | Laboratory

Instrument Maintenance | Sterilization



82-109

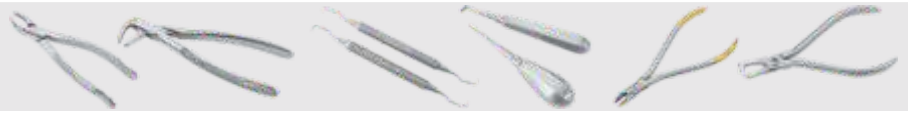
**Surgical Scissors**

Chirurgische Scheren

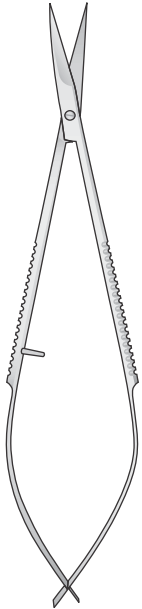
Ciseaux chirurgicaux

Tijeras quirúrgicas

Forbici Chirurgiche

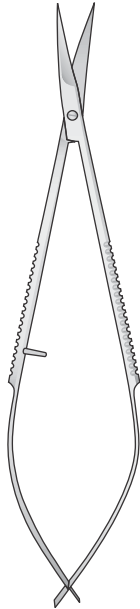


Mikro-Scheren  
Micro Scissors  
Micro Forbici  
Micro Tijeras  
Micro Ciseaux



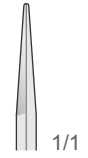
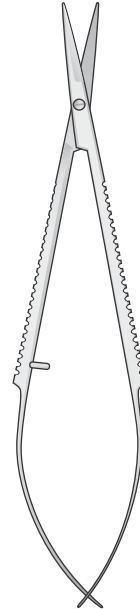
**NMI-FD-10**  
120 mm  
Spitz  
Sharp  
Acuta  
Aguda  
Pointu

NOYES  
**NMI-FD-10**  
120 mm



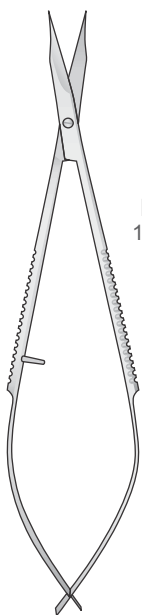
**NMI-FD-12**  
120 mm  
Spitz  
Sharp  
Acuta  
Aguda  
Pointu

NOYES  
**NMI-FD-12**  
120 mm



**NMI-FD-41** **NMI-FD-42**  
120 mm 120 mm  
Stumpf  
Blunt  
Smussa  
Romo  
Mousse

**NMI-FD-41/NMI-FD-42**  
120 mm

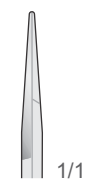
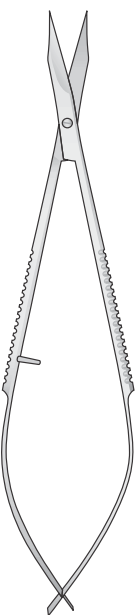


**NMI-FD-15**  
120 mm  
Spitz  
Sharp  
Acuta  
Aguda  
Pointu



**NMI-FD-13**  
120 mm  
Spitz  
Sharp  
Acuta  
Aguda  
Pointu

WESTCOTT  
**NMI-FD-13/NMI-FD-15**  
120 mm

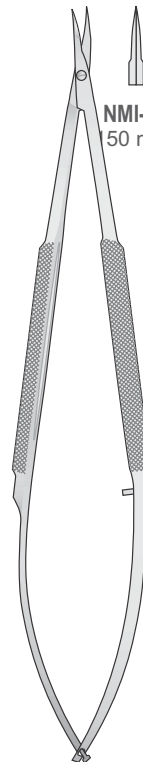


**NMI-FD-64**  
120 mm  
Stumpf  
Blunt  
Smussa  
Romo  
Mousse



**NMI-FD-65**  
120 mm  
Stumpf  
Blunt  
Smussa  
Romo  
Mousse

WESTCOTT  
**NMI-FD-64/NMI-FD-65**  
120 mm



**NMI-FD-137**  
150 mm

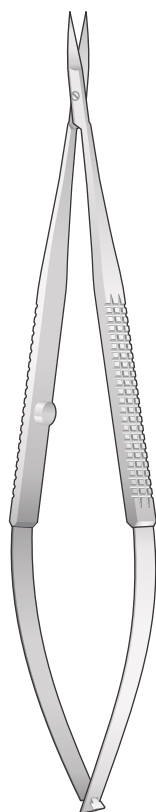


**NMI-FD-138**  
150 mm

**NMI-FD-137/NMI-FD-138**  
150 mm



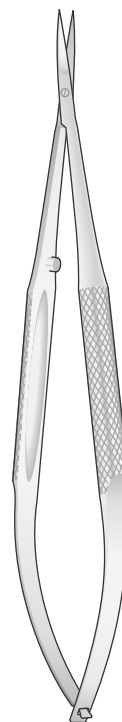
Scheren  
Scissors  
Forbici  
Tijeras  
Ciseaux



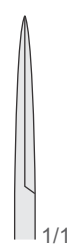
**NMI-FD-182**  
160 mm  
Spitz  
Sharp  
Acuta  
Aguda  
Pointu



**NMI-FD-183**  
160 mm  
Spitz  
Sharp  
Acuta  
Aguda  
Pointu



**NMI-FD-224**  
145 mm  
Spitz  
Sharp  
Acuta  
Aguda  
Pointu

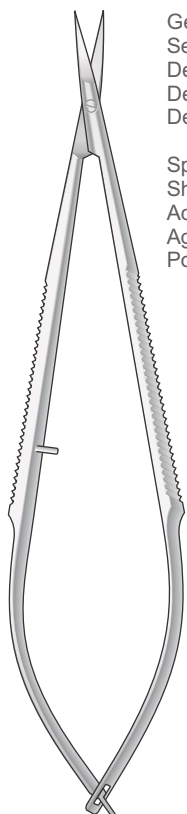


**NMI-FD-225**  
145 mm  
Spitz  
Sharp  
Acuta  
Aguda  
Pointu



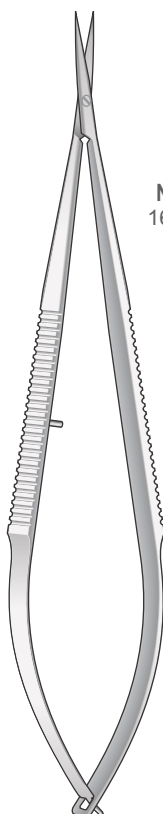
**NMI-FD-182/NMI-FD-183**  
160 mm

**NMI-FD-224/NMI-FD-225**  
145 mm



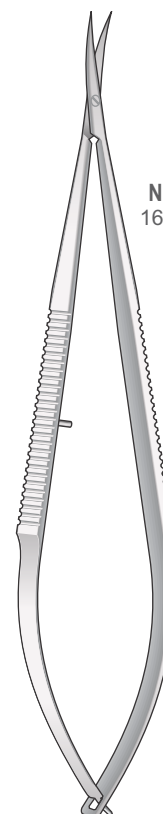
Gezahnt  
Serrated  
Dentellata  
Dentada  
Dentelé  
  
Spitz  
Sharp  
Acuta  
Aguda  
Pointu

**NMI-FD-145**  
160 mm



**NMI-FD-06**  
160 mm  
Spitz  
Sharp  
Acuta  
Aguda  
Pointu

**NMI-FD-06**  
160 mm



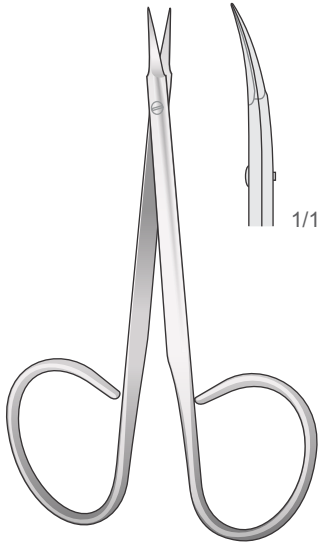
**NMI-FD-08**  
160 mm  
Spitz  
Sharp  
Acuta  
Aguda  
Pointu

**NMI-FD-08**  
160 mm



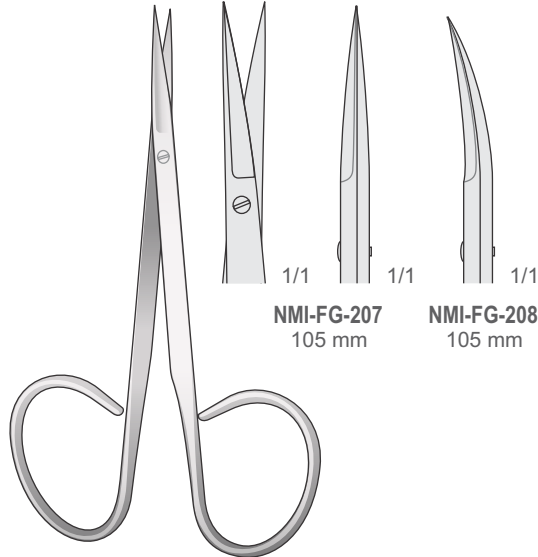
Scheren  
Scissors  
Forbici  
Tijeras  
Ciseaux

Spitz - Sharp  
Acuta - Aguda  
Pointu



STITCH  
NMI-FG-216  
1

Iris Scheren - Iris scissors  
Forbici Iris - Tijeras Iris  
Ciseaux Iris

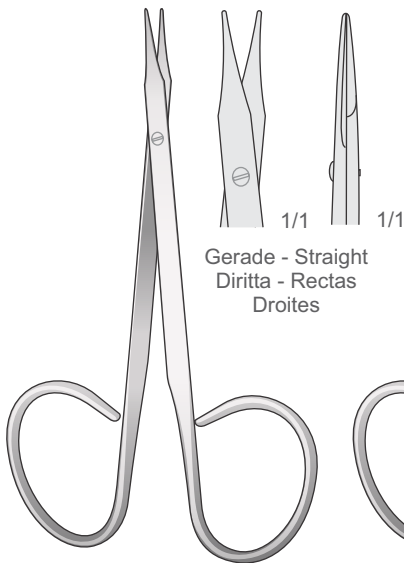


NMI-FG-207  
105 mm

NMI-FG-208  
105 mm

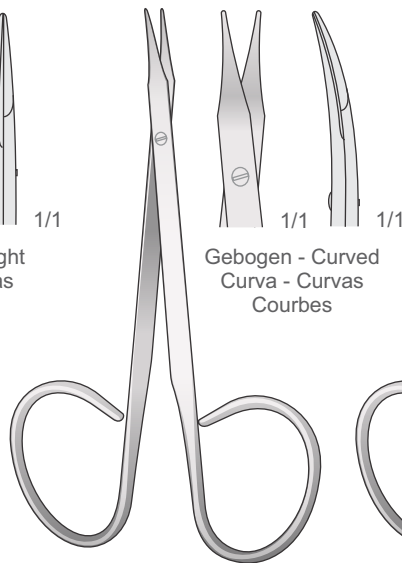
15 mm  
NMI-FG-207/NMI-FG-208  
105 mm

Stumpf - Blunt  
Smussa - Romas  
Mousse



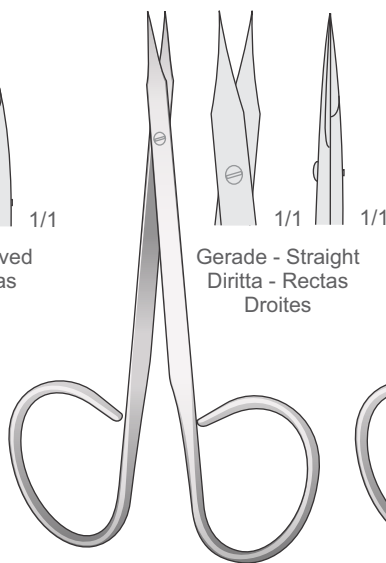
STEVENS  
NMI-FG-209  
100 mm

Stumpf - Blunt  
Smussa - Romas  
Mousse



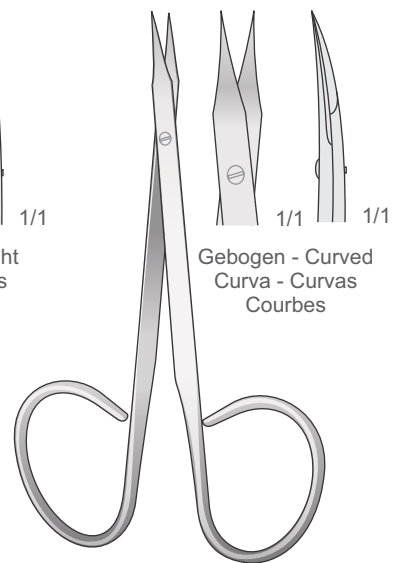
STEVENS  
NMI-FG-210  
100 mm

Spitz - Sharp  
Acuta - Aguda  
Pointu



WALTON  
NMI-FG-21 100 mm 1

Spitz - Sharp  
Acuta - Aguda  
Pointu



WALTON  
NMI-FG-212  
100 mm

Gerade - Straight  
Diritta - Rectas  
Droites

Gebogen - Curved  
Curva - Curvas  
Courbes

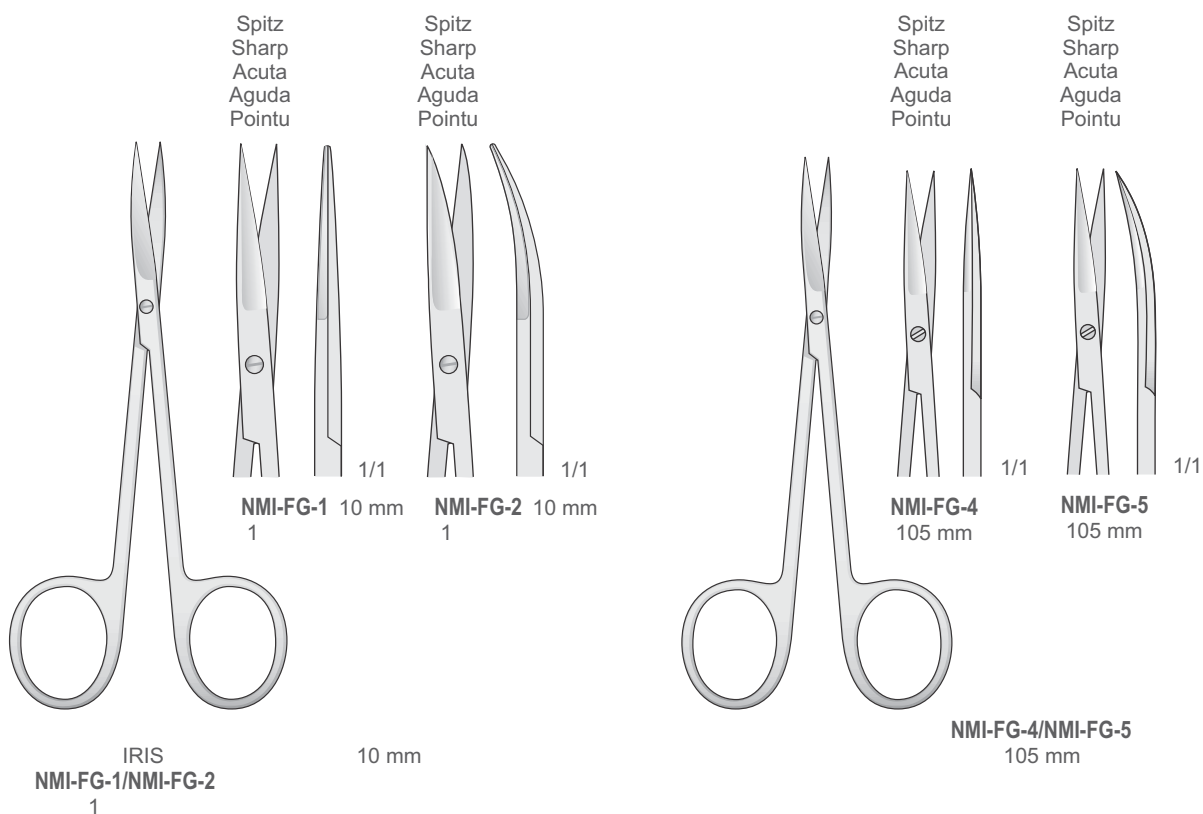
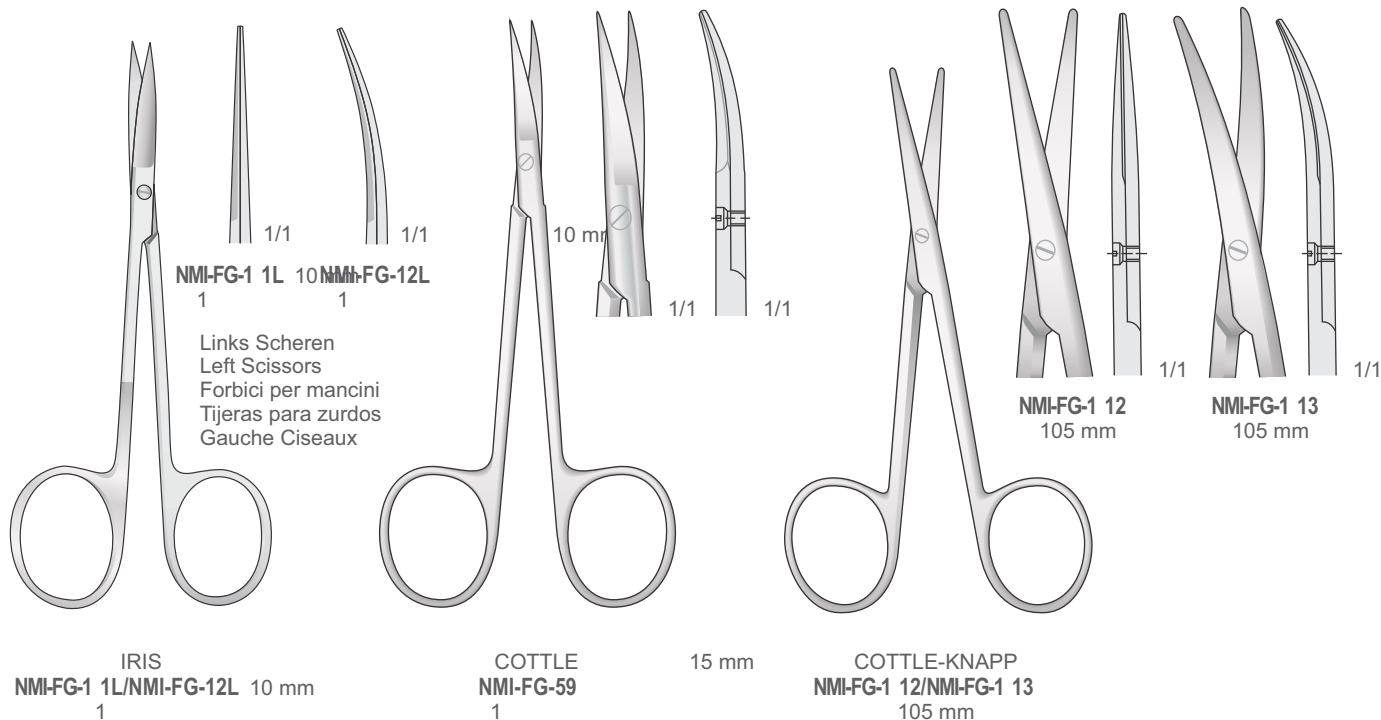
Gerade - Straight  
Diritta - Rectas  
Droites

Gebogen - Curved  
Curva - Curvas  
Courbes



Scheren  
Scissors  
Forbici  
Tijeras  
Ciseaux

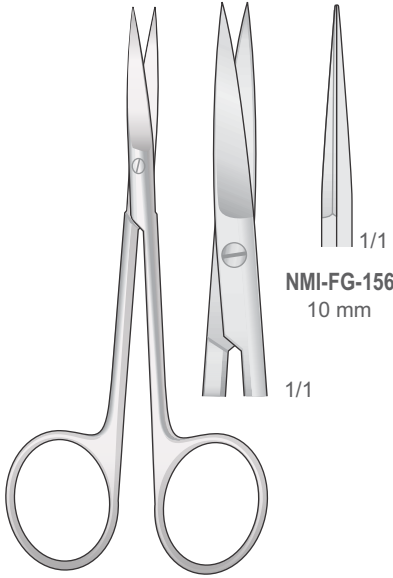
L = links  
left  
mancini  
izquierdo  
gauche



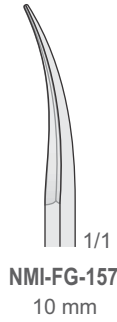


Scheren  
Scissors  
Forbici  
Tijeras  
Ciseaux

Gezahnt - Serrated  
Dentellata - Dentelé - Dentadas



**NMI-FG-156**  
10 mm

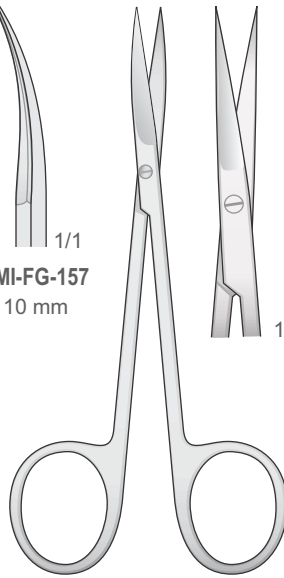


**NMI-FG-157**  
10 mm

**NMI-FG-156/NMI-FG-157**  
1

10 mm

Gezahnt - Serrated  
Dentellata - Dentelé - Dentadas

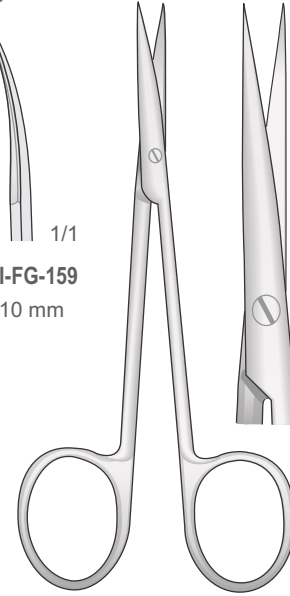


**NMI-FG-158**  
10 mm

**NMI-FG-159**  
10 mm

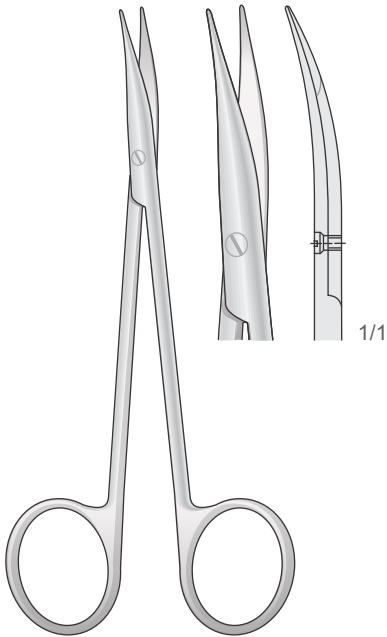
**NMI-FG-158/NMI-FG-159**  
1

10 mm

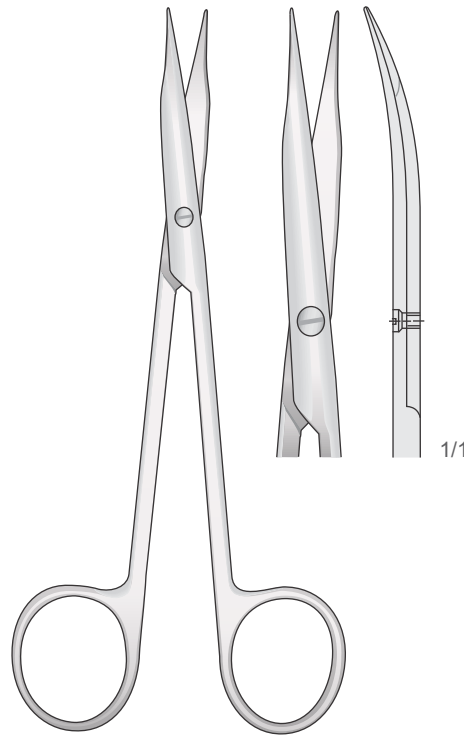


**KILNER**  
**NMI-FG-58**  
1

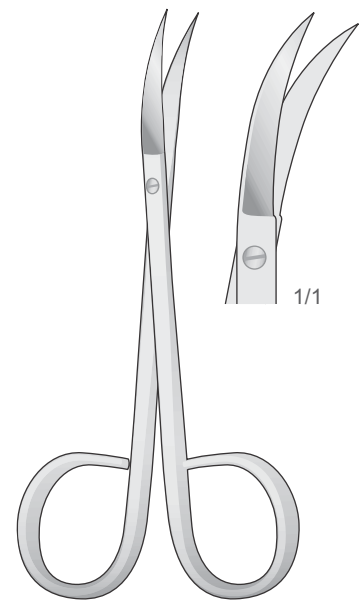
15 mm



**JAMESON-WERBER**  
**NMI-FG-123**  
130 mm



**JAMESON**  
**NMI-FG-124**  
145 mm



15 mm  
**NMI-FG-3**  
1



Scheren  
Scissors  
Forbici  
Tijeras  
Ciseaux

Spitz  
Sharp  
Acuta  
Aguda  
Pointu

Spitz  
Sharp  
Acuta  
Aguda  
Pointu

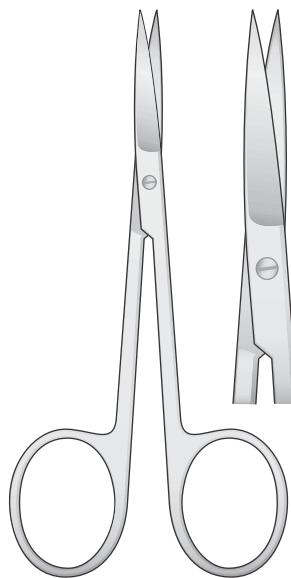


**NMI-FG-13**  
85 mm

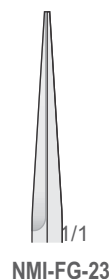
**NMI-FG-15**  
85 mm



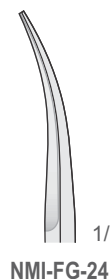
**MICRO-IRIS**  
**NMI-FG-13/NMI-FG-15**  
85 mm



**NMI-FG-23/NMI-FG-24**  
1

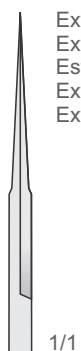


**NMI-FG-23**

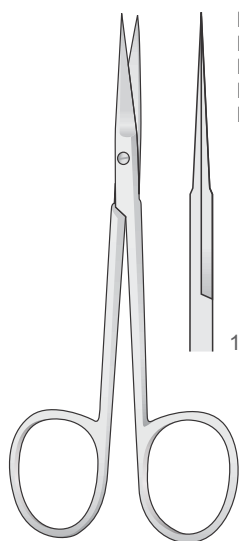


**NMI-FG-24**

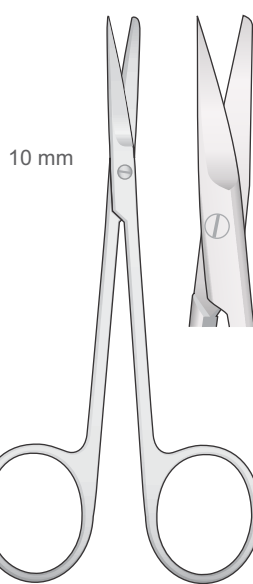
Extra flach  
Extra flat  
Estremamente piatta  
Extra plano  
Extrêmement plat



1/1



**NMI-FG-104**  
100 mm



10 mm

**NMI-FG-103/NMI-FG-105**  
1



1/1



1/1

**NMI-FG-105**

1/1  
**NMI-FG-103**

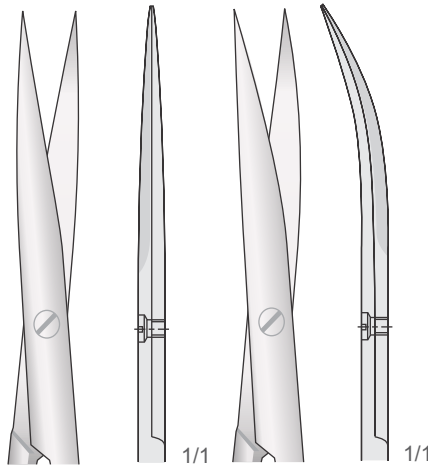
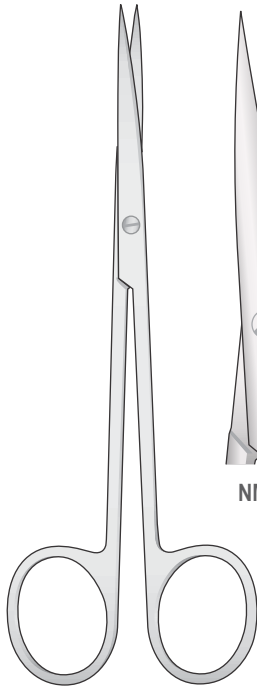
10 mm



Scheren  
Scissors  
Forbici  
Tijeras  
Ciseaux

Spitz - Sharp  
Acuta - Agudo  
Aigu

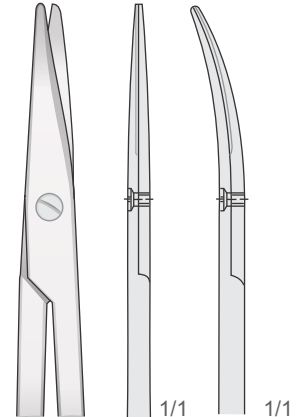
Spitz - Sharp  
Acuta - Agudo  
Aigu



**NMI-FM-126**

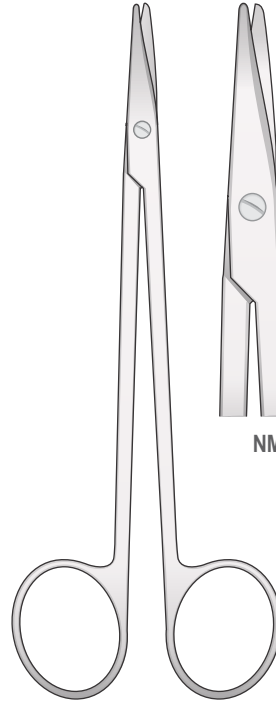
**NMI-FM-127**

**METZENBAUM**  
**NMI-FM-126/NMI-FM-127**  
145 mm

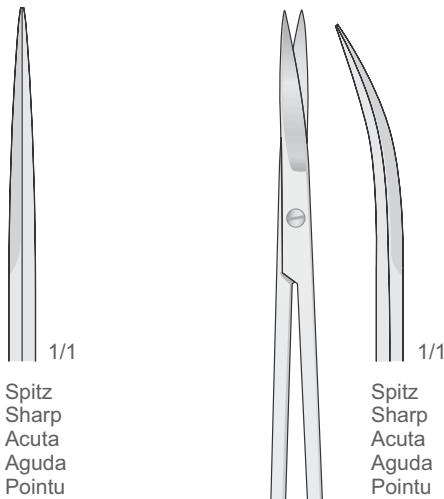
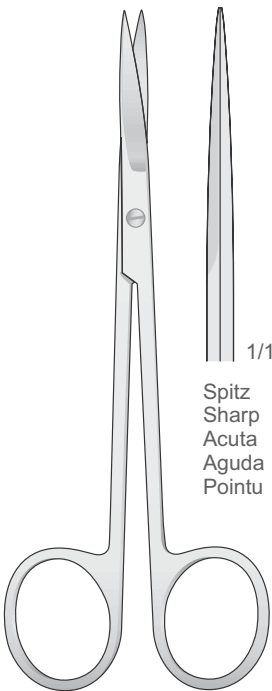


**NMI-FM-12**

**NMI-FM-109**

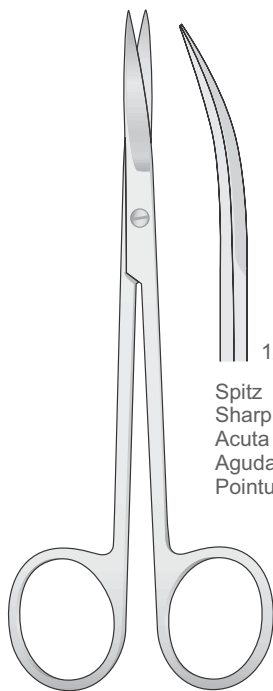


**METZENBAUM**  
**NMI-FM-12/NMI-FM-109**  
150 mm



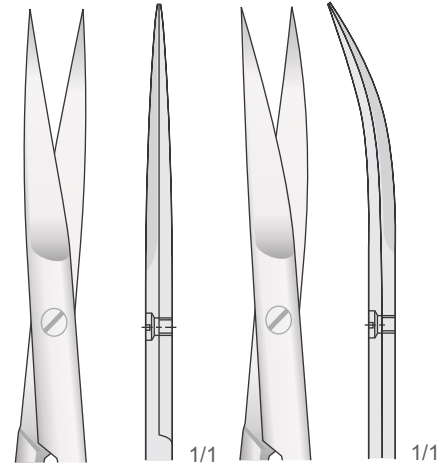
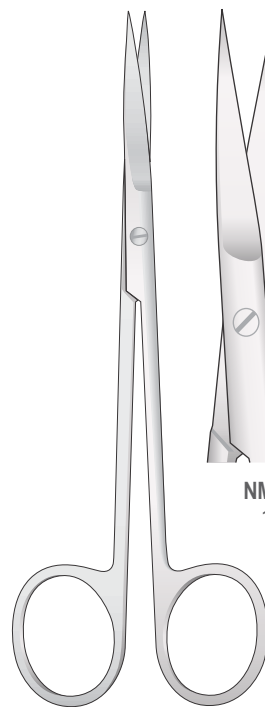
Spitz  
Sharp  
Acuta  
Aguda  
Pointu

**METZENBAUM**  
**NMI-FG-28**  
145 mm



Spitz  
Sharp  
Acuta  
Aguda  
Pointu

**METZENBAUM**  
**NMI-FG-14**  
145 mm



**NMI-FG-147**  
150 mm

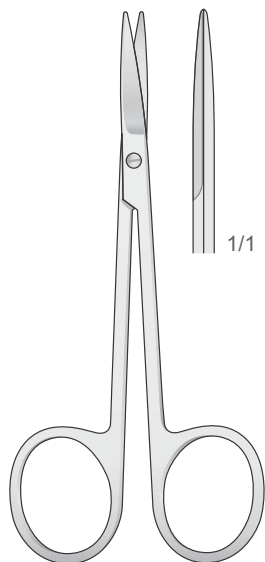
**NMI-FG-148**  
150 mm

**JOSEPH**  
**NMI-FG-147/NMI-FG-148**  
150 mm



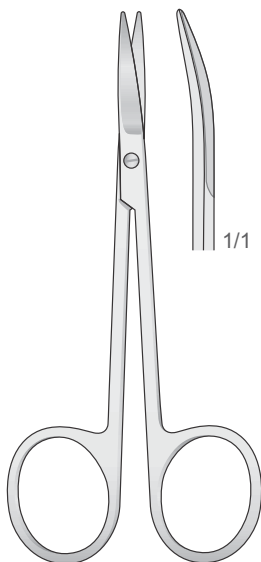
Scheren  
Scissors  
Forbici  
Tijeras  
Ciseaux

Stumpf  
Blunt  
Smussa  
Romas  
Mousse



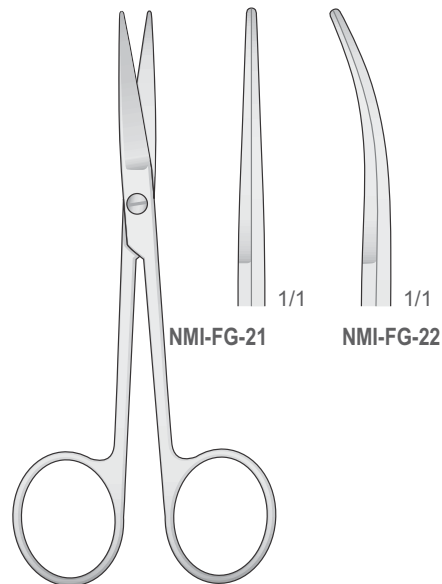
**NMI-FG-101** 10 mm  
1

Stumpf  
Blunt  
Smussa  
Romas  
Mousse



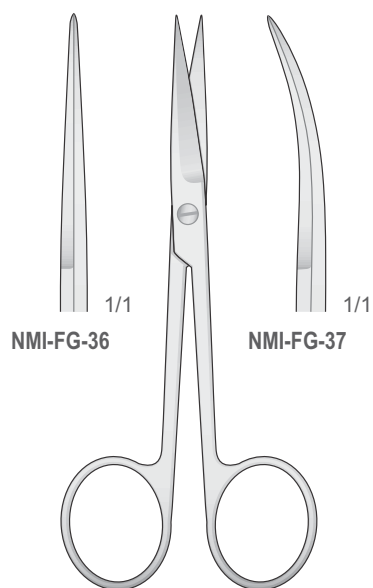
**NMI-FG-102** 10 mm  
1

Stumpf  
Blunt  
Smussa  
Romas  
Mousse

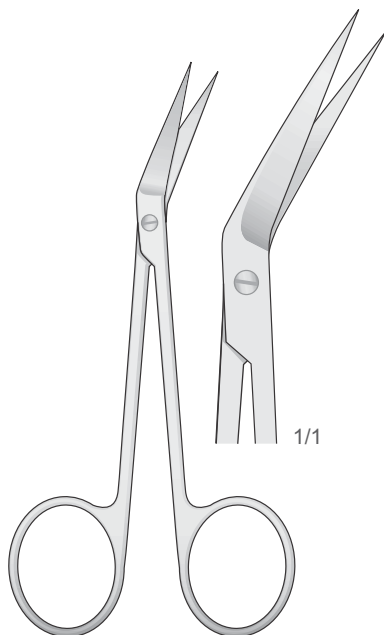


**NMI-FG-21/NMI-FG-22**  
15 mm 1

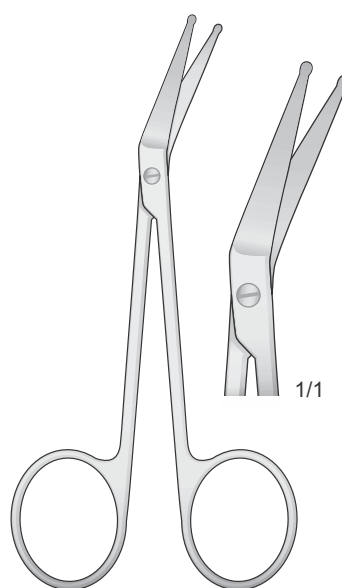
Spitz  
Sharp  
Acute  
Agudas  
Pointu



**NMI-FG-36/NMI-FG-37** 15 mm  
1



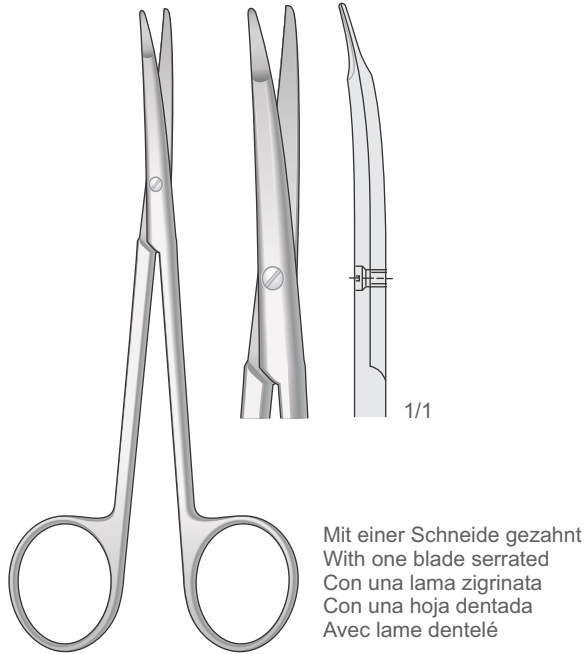
**LOCKLIN**  
**NMI-LK-1** 15 mm  
1



**LOCKLIN MOD.**  
**NMI-LK-3** 10 mm  
1

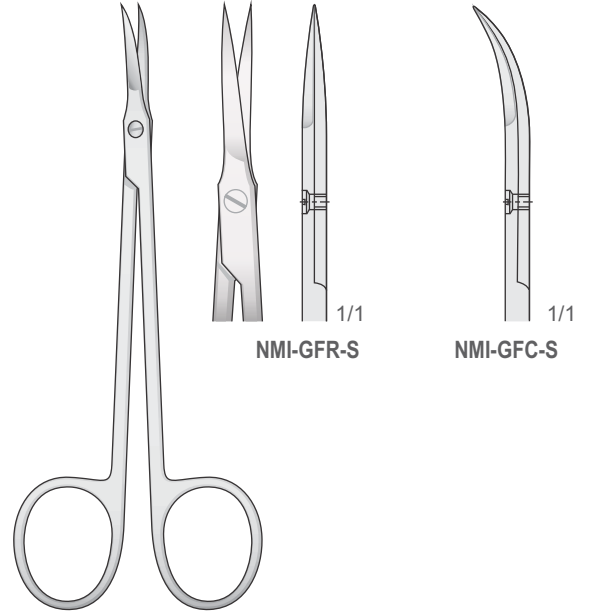


Scheren  
Scissors  
Forbici  
Tijeras  
Ciseaux



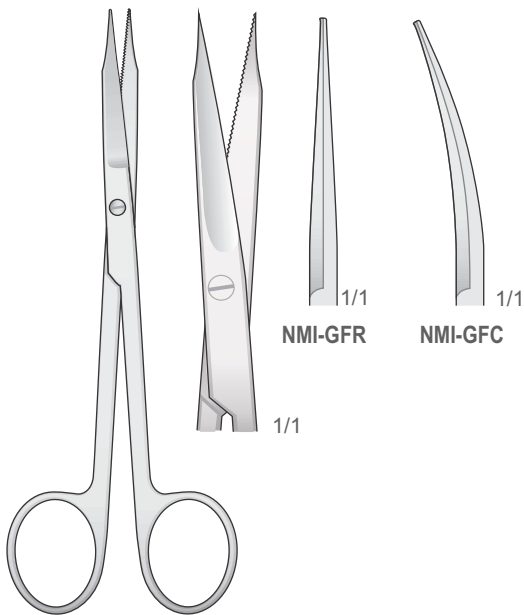
**KILNER**  
**NMI-FG-121**  
130 mm

Mit einer Schneide gezahnt  
With one blade serrated  
Con una lama zigrinata  
Con una hoja dentada  
Avec lame dentelé



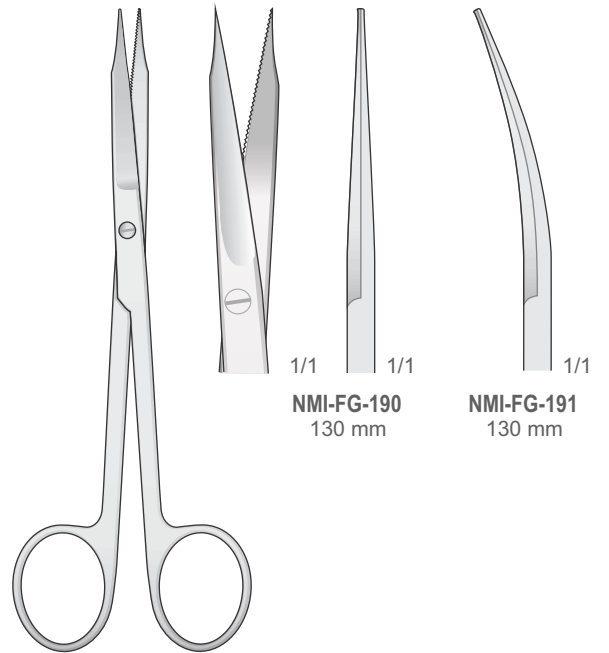
**NMI-GFR-S/NMI-GFC-S**  
120 mm

Gezahnt - Serrated  
Dentellata - Dentadas  
Dentelé



**GOLDMAN-FOX**  
**GFR/GFC**  
120 mm

Gezahnt - Serrated  
Dentellata - Dentadas  
Dentelé

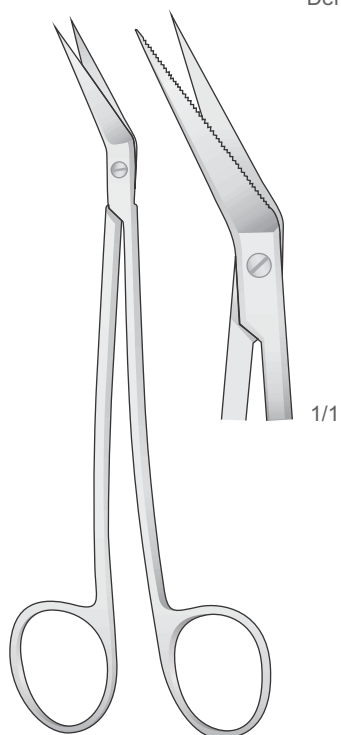


**GOLDMAN-FOX**  
**NMI-FG-190/NMI-FG-191**  
130 mm

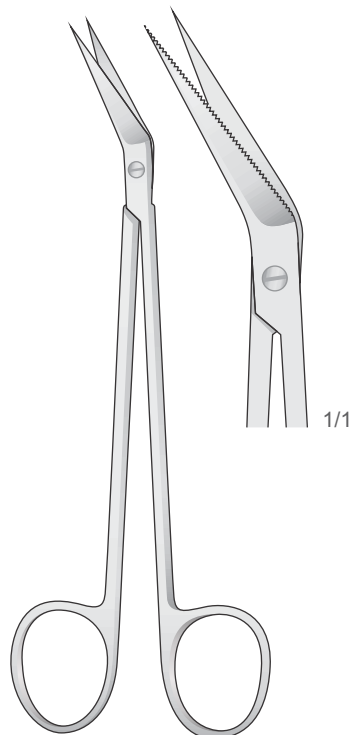


Scheren  
Scissors  
Forbici  
Tijeras  
Ciseaux

Gezahnt - Serrated  
Dentellata - Dentadas  
Dentelé

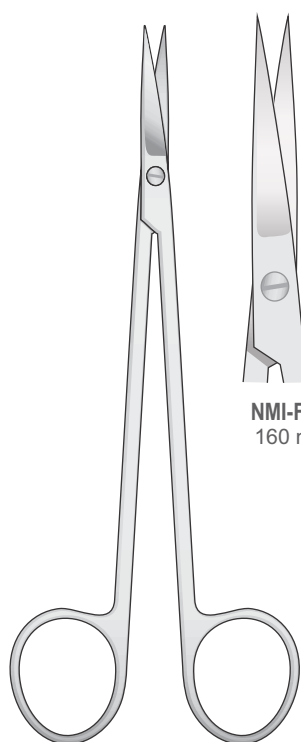


**LOCKLIN  
NMI-LK-2**  
160 mm

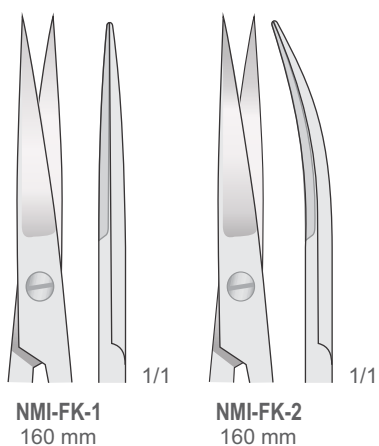


**LOCKLIN  
NMI-LK-4**  
160 mm

Gezahnt - Serrated  
Dentellata - Dentadas  
Dentelé

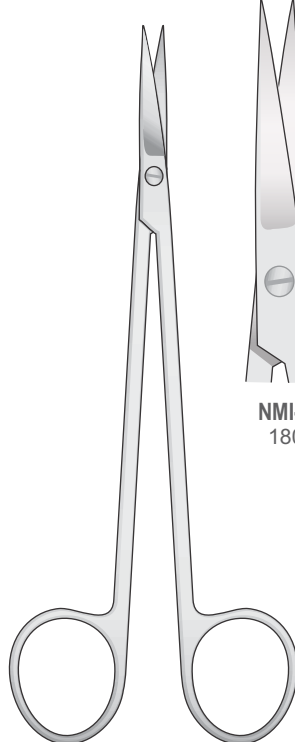


**KELLY  
NMI-FK-1 / NMI-FK-2**  
160 mm

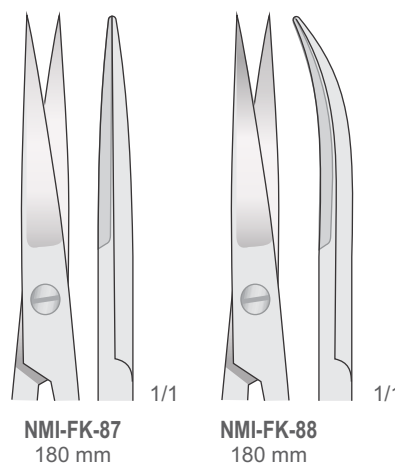


**NMI-FK-1**  
160 mm

**NMI-FK-2**  
160 mm



**KELLY  
NMI-FK-87 / NMI-FK-88**  
180 mm

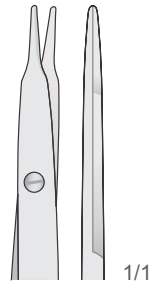
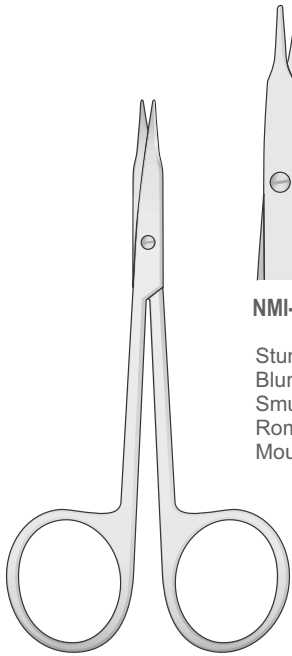


**NMI-FK-87**  
180 mm

**NMI-FK-88**  
180 mm

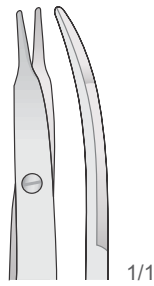


Scheren  
Scissors  
Forbici  
Tijeras  
Ciseaux



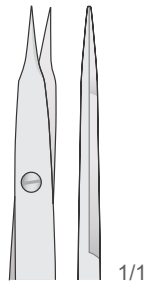
**NMI-FG-50**

Stumpf Gerade  
Blunt Straight  
Smussa Diritta  
Romas Rectas  
Mousse Droites



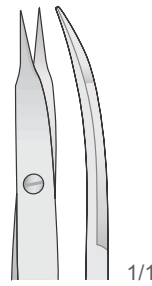
**NMI-FG-51**

Stumpf Gebogen  
Blunt Curved  
Smussa Curva  
Romas Curvas  
Mousse Courbes



**NMI-FG-52**

Spitz Gerade  
Sharp Straight  
Acuta Diritta  
Agudas Rectas  
Pointu Droites



**NMI-FG-53**

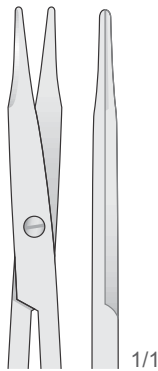
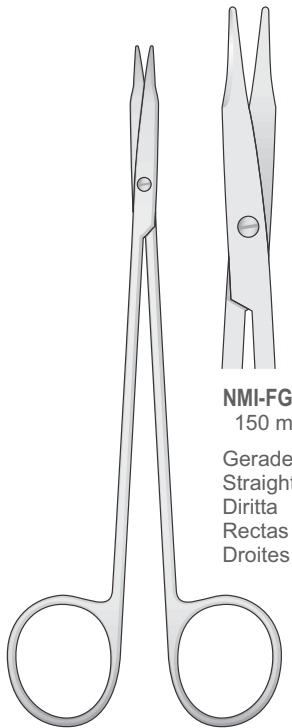
Spitz Gebogen  
Sharp Curved  
Acuta Curva  
Agudas Curvas  
Pointu Courbes

STEVENS

10 mm

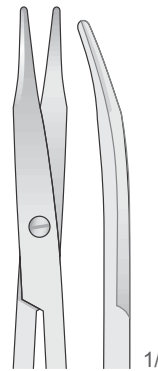
**NMI-FG-50/NMI-FG-53**

1



**NMI-FG-54**  
150 mm

Gerade  
Straight  
Diritta  
Rectas  
Droites



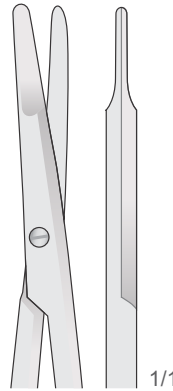
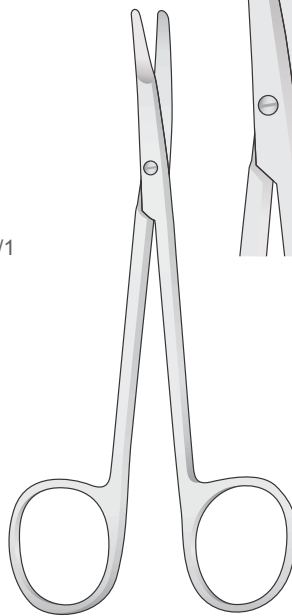
**NMI-FG-55**  
150 mm

Gebogen  
Curved  
Curva  
Curvas  
Courbes

Stumpf  
Blunt  
Smussa  
Romas  
Mousse

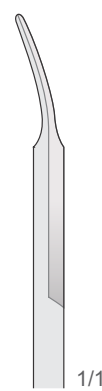
REYNOLDS

**NMI-FG-54/NMI-FG-55**



**NMI-FG-66**  
120 mm

Gerade  
Straight  
Diritta  
Rectas  
Droites



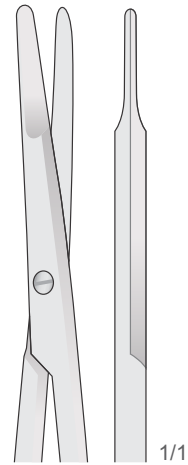
**NMI-FG-67**  
120 mm

Gebogen  
Curved  
Curva  
Curvas  
Courbes

Stumpf  
Blunt  
Smussa  
Romas  
Mousse

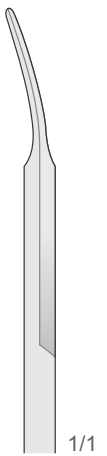
KILNER

**NMI-FG-19C/NMI-FG-67**



**NMI-FG-19R**  
135 mm

Gerade  
Straight  
Diritta  
Rectas  
Droites



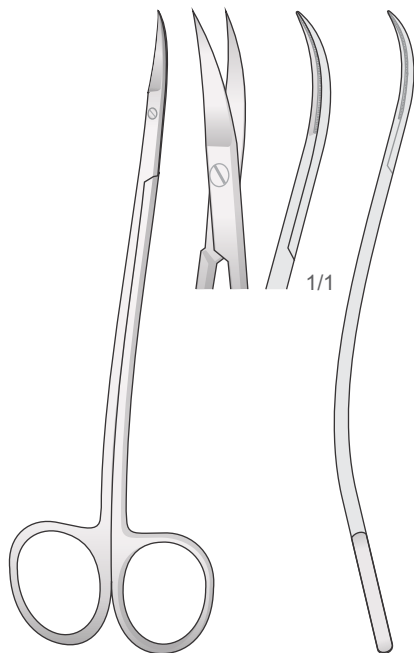
**NMI-FG-19C**  
135 mm

Gebogen  
Curved  
Curva  
Curvas  
Courbes



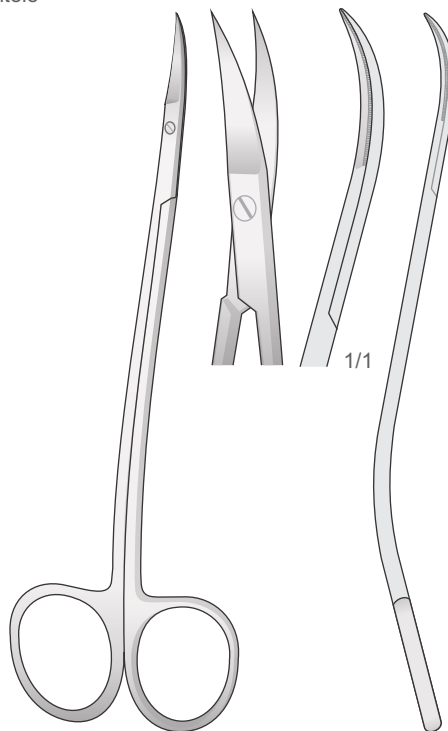
Scheren  
Scissors  
Forbici  
Tijeras  
Ciseaux

Gezahnt - Serrated  
Dentellata - Dentadas  
Dentelé



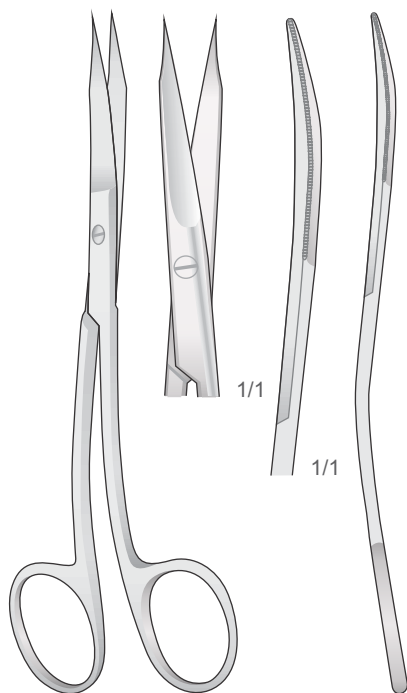
LA GRANGE  
**NMI-LG-1**  
1

15 mm

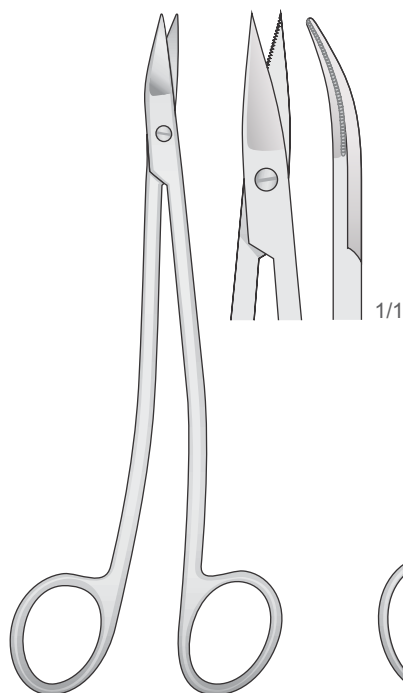


LA GRANGE  
**NMI-LG-6**  
155 mm

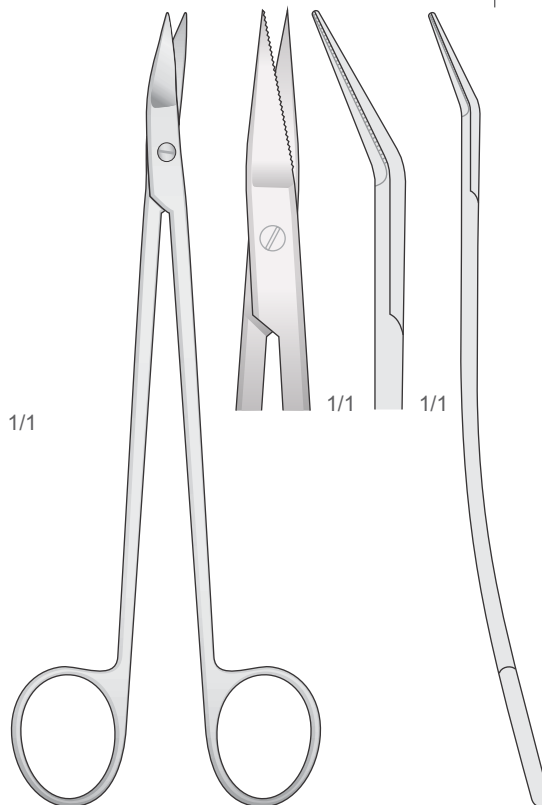
Gezahnt - Serrated  
Dentellata - Dentada  
Dentée



GOLDMAN-FOX S FORM  
**GFS**  
130 mm



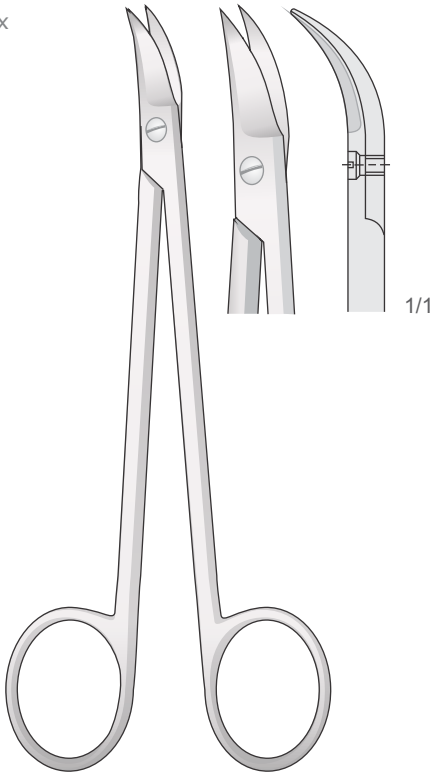
NEUMANN  
**NMI-FG-20**  
130 mm



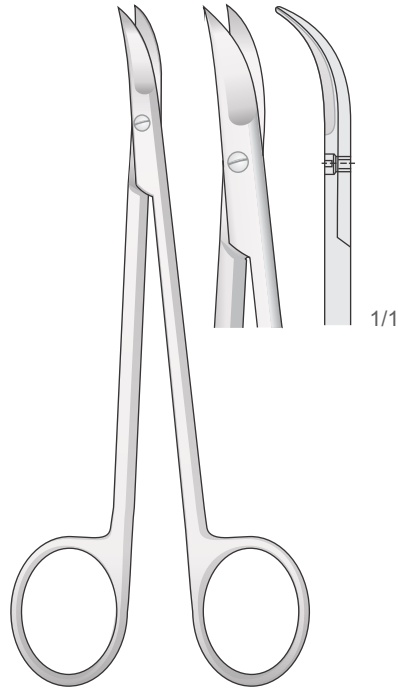
DEAN  
**DEAN**  
180 mm



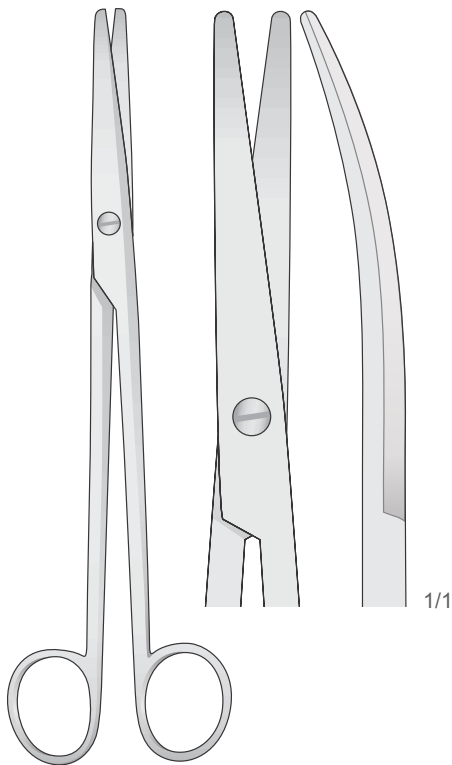
Scheren  
Scissors  
Forbici  
Tijeras  
Ciseaux



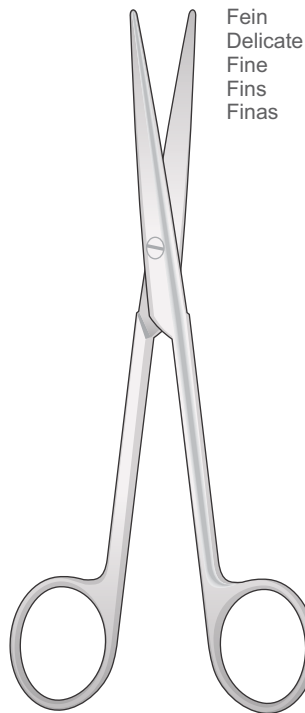
QUINBY  
NMI-FG-38  
130 mm



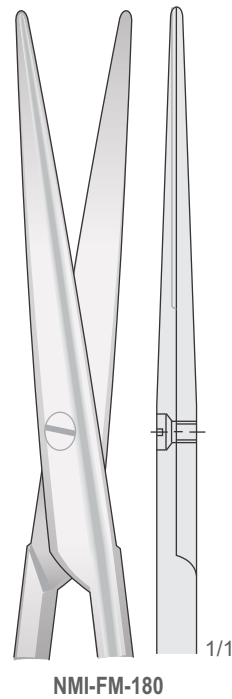
CHADWICK  
NMI-FG-39  
15 mm  
1



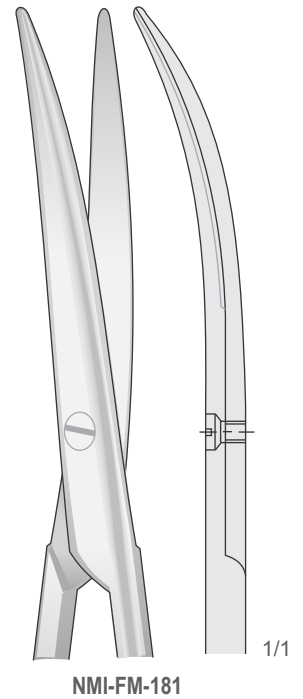
MAYO-LEXER  
NMI-FM-79  
165 mm



LEXER  
NMI-FM-180/NMI-FM-181  
165 mm



NMI-FM-180



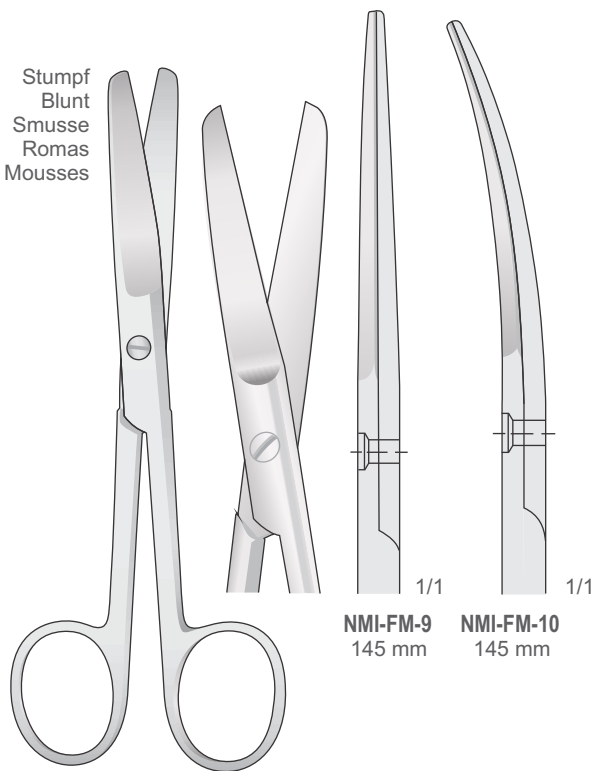
NMI-FM-181

Fein  
Delicate  
Fine  
Fins  
Finas



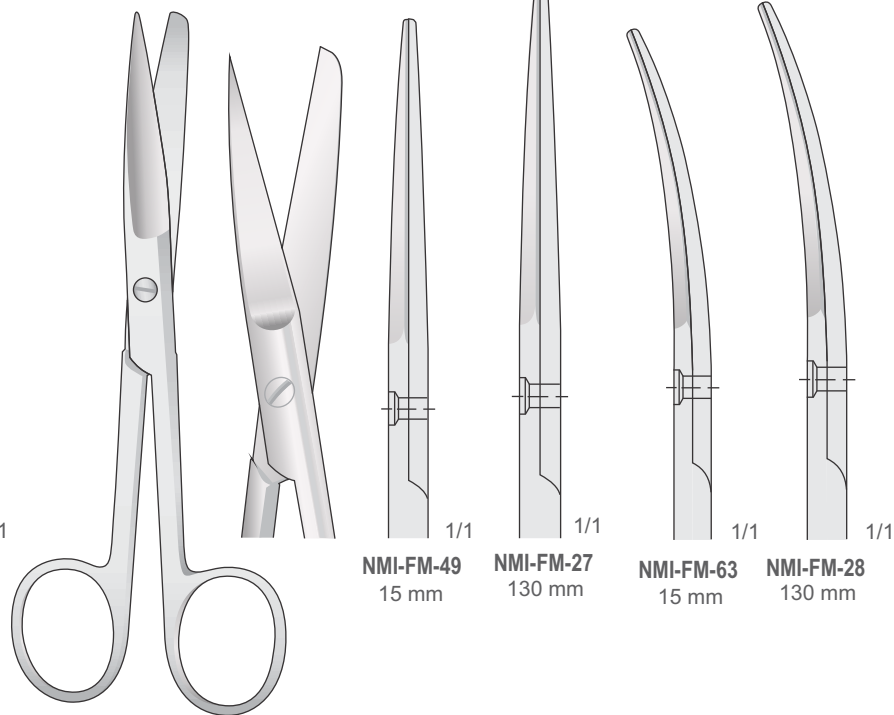
Scheren  
Scissors  
Forbici  
Tijeras  
Ciseaux

Stumpf  
Blunt  
Smusse  
Romas  
Mousses



**NMI-FM-9**  
145 mm

**NMI-FM-10**  
145 mm



**NMI-FM-49**  
15 mm

**NMI-FM-27**  
130 mm

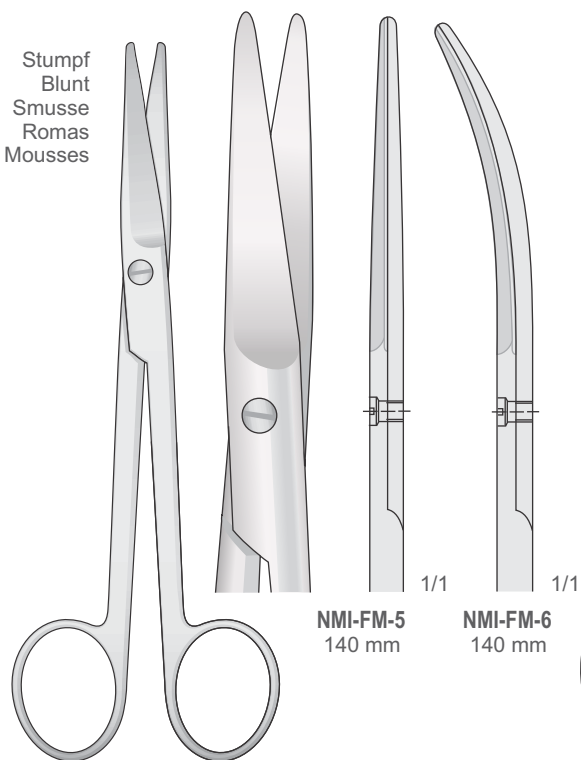
**NMI-FM-63**  
15 mm

**NMI-FM-28**  
130 mm

**NMI-FM-9/NMI-FM-10**  
145 mm

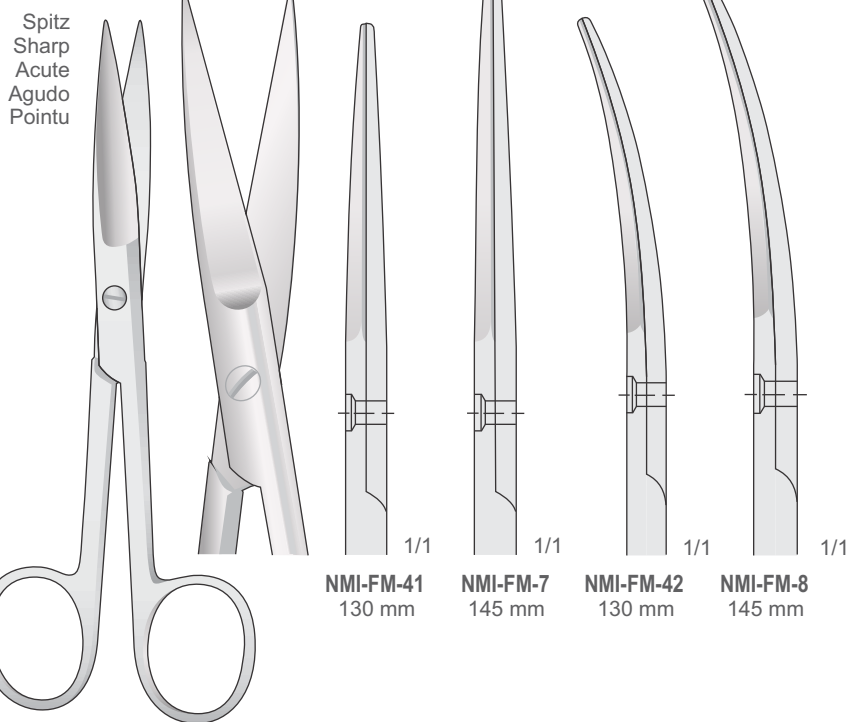
**NMI-FM-27/NMI-FM-63**

Stumpf  
Blunt  
Smusse  
Romas  
Mousses



**NMI-FM-5**  
140 mm

**NMI-FM-6**  
140 mm



**NMI-FM-41**  
130 mm

**NMI-FM-7**  
145 mm

**NMI-FM-42**  
130 mm

**NMI-FM-8**  
145 mm

**NMI-FM-7/NMI-FM-42**

MAYO  
**NMI-FM-5/NMI-FM-6**  
140 mm



Scheren  
Scissors  
Forbici  
Tijeras  
Ciseaux

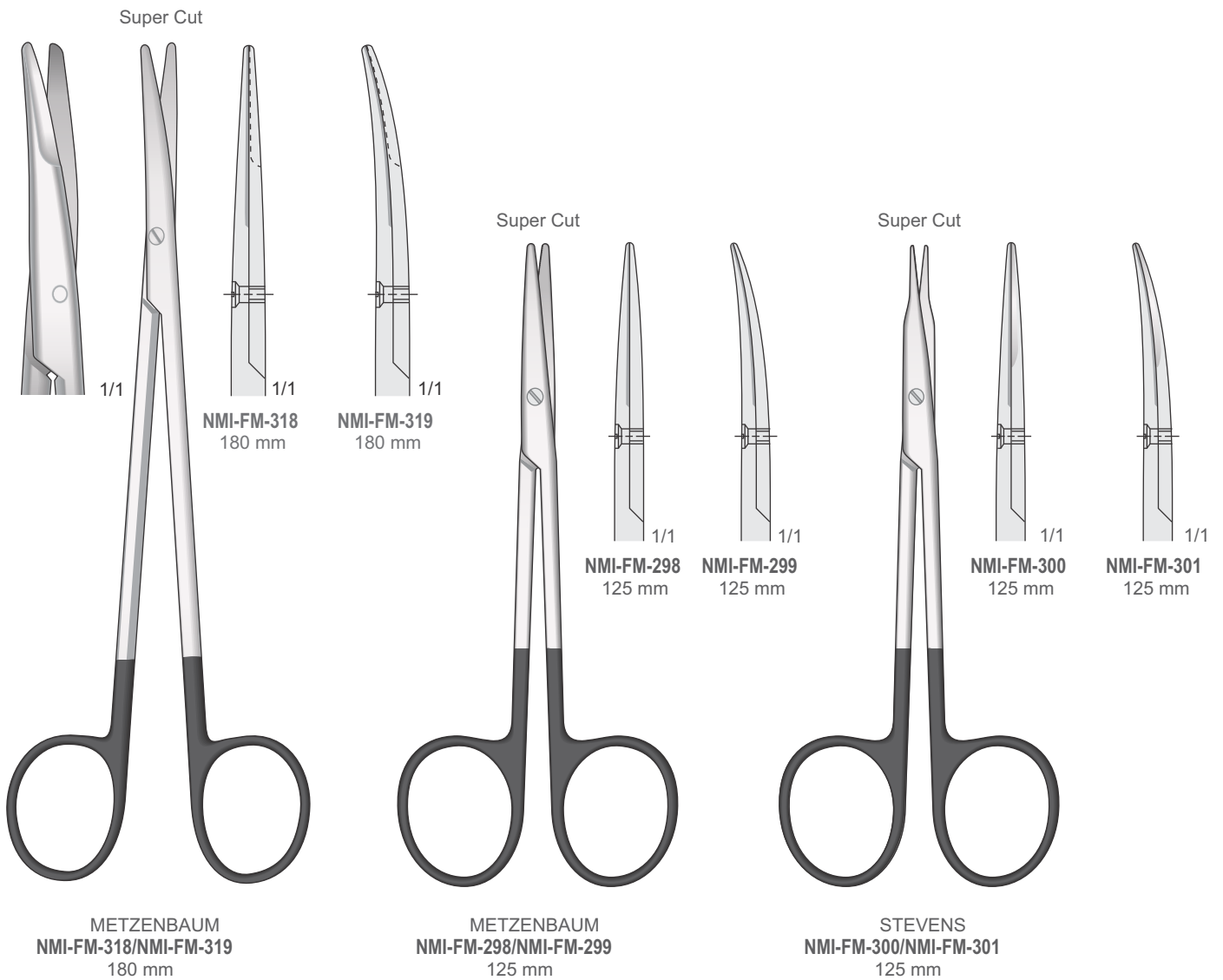
## SUPER CUT



Super Cut Scissors have specially designed cutting edges.  
One regular edge and **one sharp-knife edge**.

**Extremely Sharp Razor Edge / Atraumatic**  
Extrem Scharfe Spitzer Beck / Atraumatische  
Tranchant extrêmement aiguisée / Atraumatique  
Borde extremadamente alado / Atraumática  
Taglio estremamente alato / Atraumatica

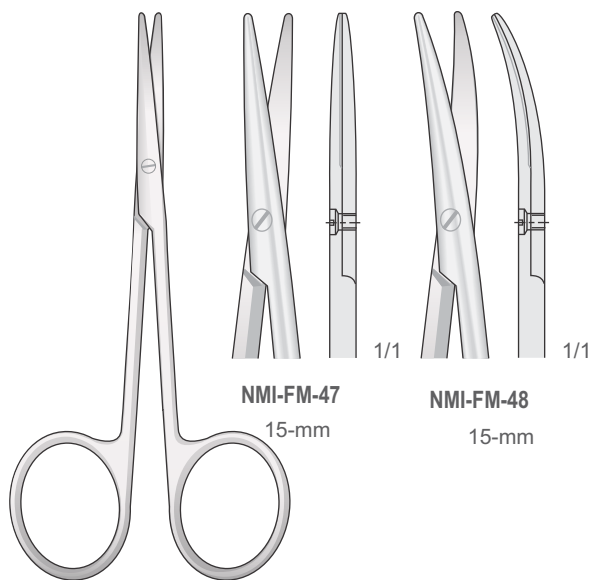
**One side serrated**  
Eine seite gezahnt  
Un côté dentelé  
Un lado dentado  
Un lato dentellato





Scheren  
Scissors  
Forbici  
Tijeras  
Ciseaux

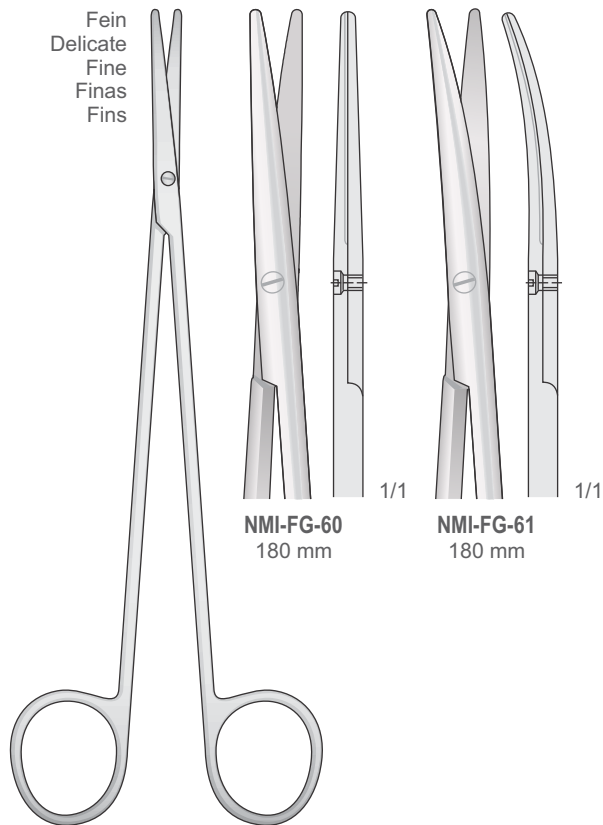
Fein  
Delicate  
Fine  
Finas  
Fins



**NMI-FM-47**  
15-mm

**NMI-FM-48**  
15-mm

BABY - METZENBAUM  
**NMI-FM-47/NMI-FM-48**  
1

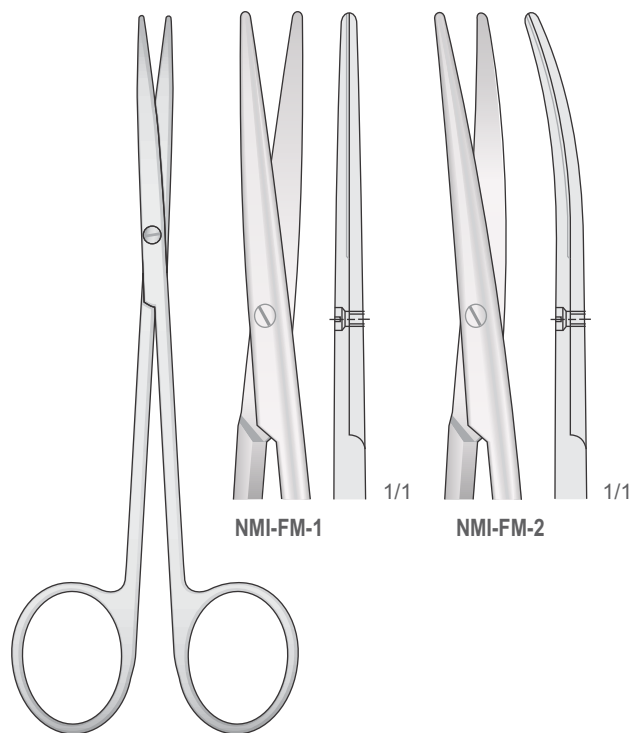


**NMI-FG-60**  
180 mm

**NMI-FG-61**  
180 mm

TOENNIS-ADSON  
**NMI-FG-60/NMI-FG-61**  
180 mm

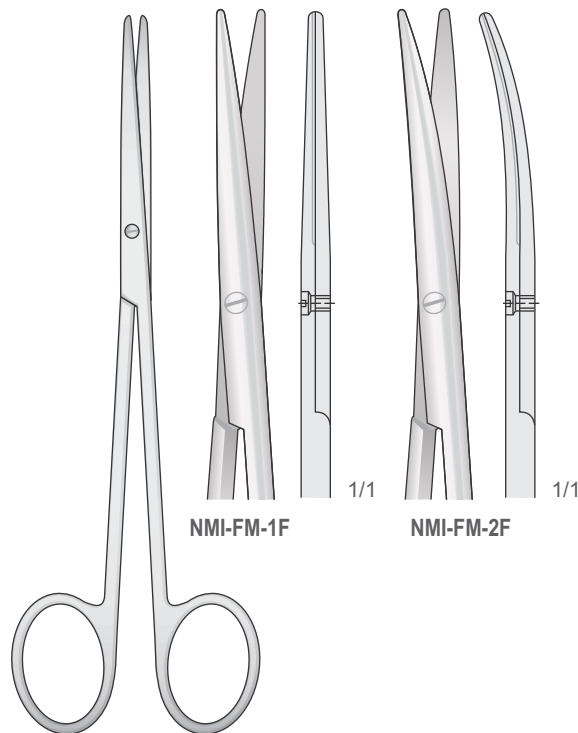
Präparierscheren - Dissecting Scissors  
Forbici per dissezione - Tijeras de disección - Ciseaux à dissection



**NMI-FM-1**

**NMI-FM-2**

METZENBAUM  
**NMI-FM-1/NMI-FM-2**  
145 mm



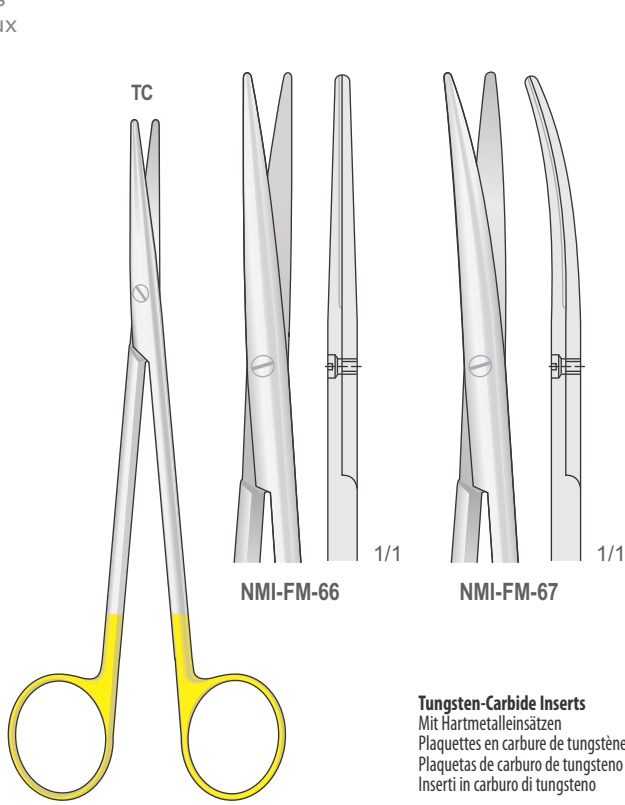
**NMI-FM-1F**

**NMI-FM-2F**

METZENBAUM-FINO  
**NMI-FM-1F/NMI-FM-2F**  
145 mm

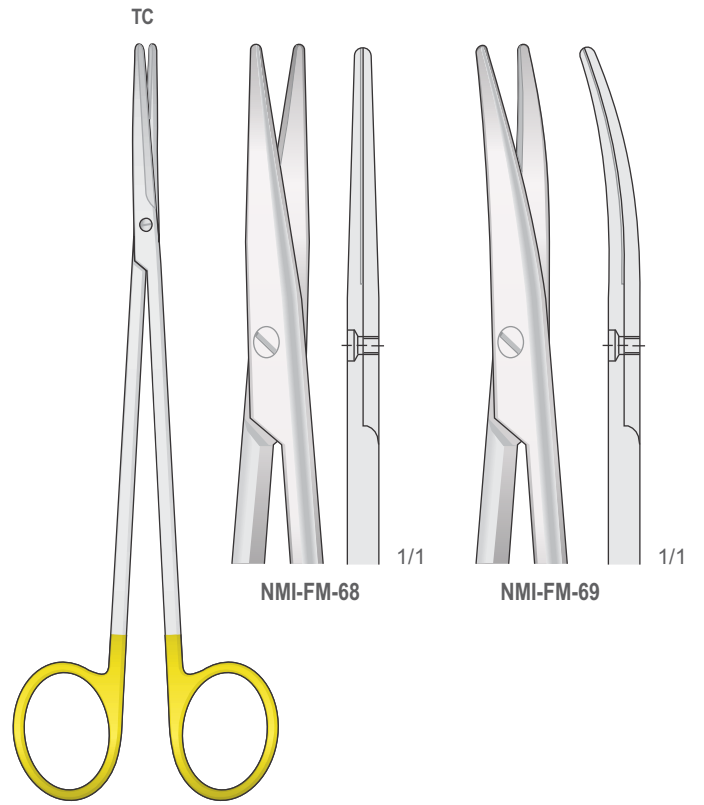


Scheren  
Scissors  
Forbici  
Tijeras  
Ciseaux

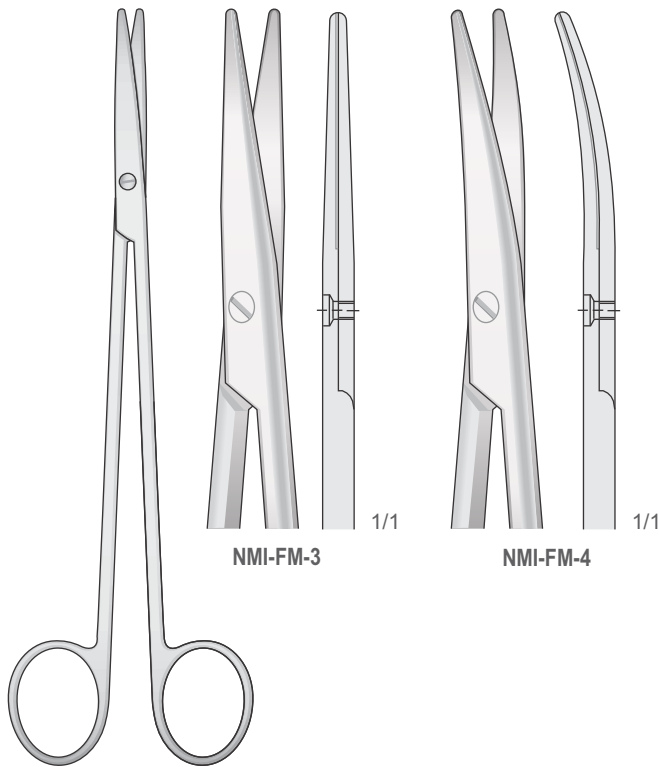


METZENBAUM  
NMI-FM-66/NMI-FM-67  
145 mm

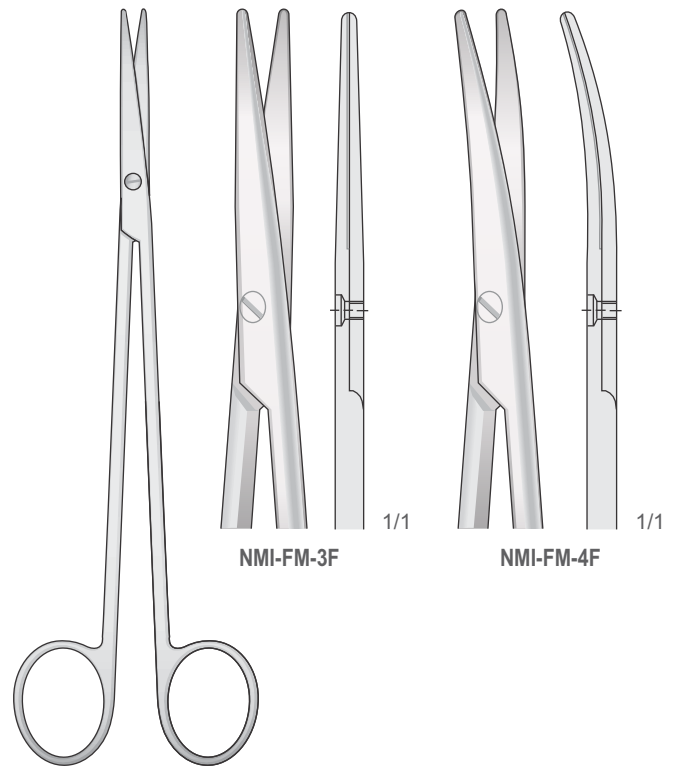
**Tungsten-Carbide Inserts**  
Mit Hartmetalleinsätzen  
Plaquettes en carbure de tungstène  
Plaquetas de carburo de tungsteno  
Inserti in carburo di tungsteno



METZENBAUM  
NMI-FM-68/NMI-FM-69  
185 mm



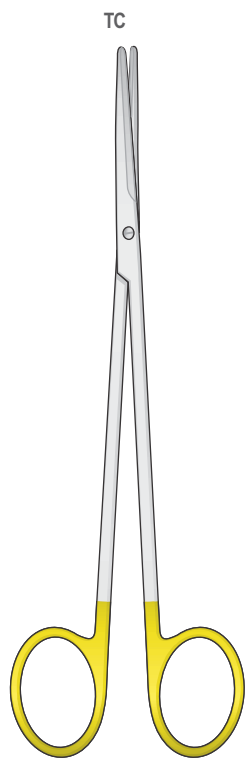
METZENBAUM  
NMI-FM-3/NMI-FM-4  
185 mm



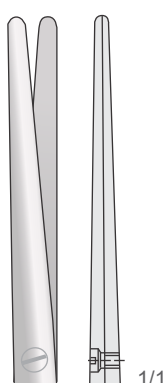
METZENBAUM-FINO  
NMI-FM-3F/NMI-FM-4F  
185 mm



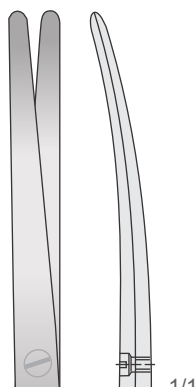
Scheren  
Scissors  
Forbici  
Tijeras  
Ciseaux



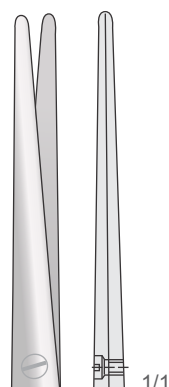
METZENBAUM-FINO  
NMI-FM-201/NMI-FM-204



**NMI-FM-201**  
140 mm



**NMI-FM-202**  
140 mm

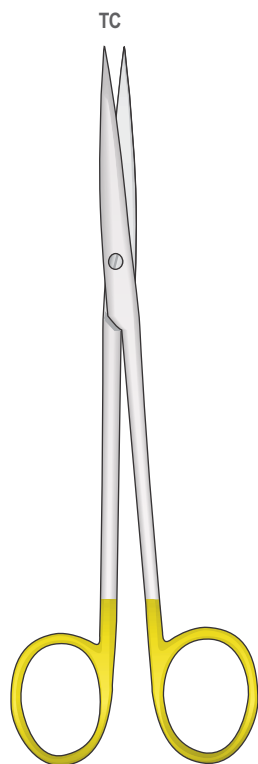


**NMI-FM-203**  
180 mm

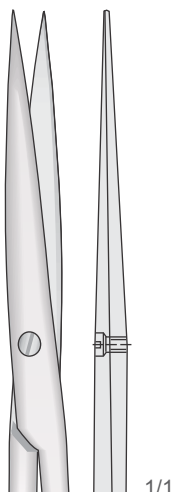


**NMI-FM-204**  
180 mm

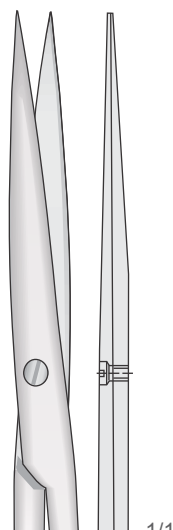
**Tungsten-Carbide Inserts**  
Mit Hartmetalleinsätzen  
Plaquettes en carbure de tungstène  
Plaquetas de carburo de tungsteno  
Inserti in carburo di tungsteno



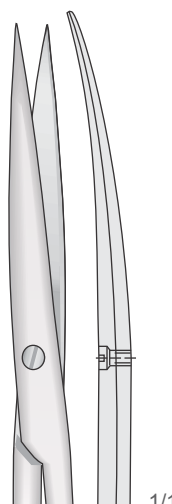
METZENBAUM-FINO  
NMI-FM-96/NMI-FM-99



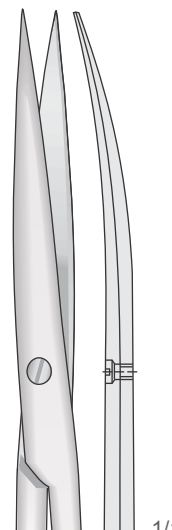
**NMI-FM-96**  
140 mm



**NMI-FM-97**  
180 mm



**NMI-FM-98**  
140 mm

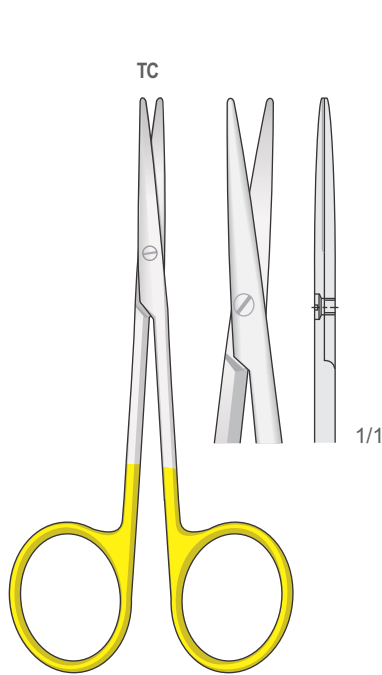


**NMI-FM-99**  
180 mm

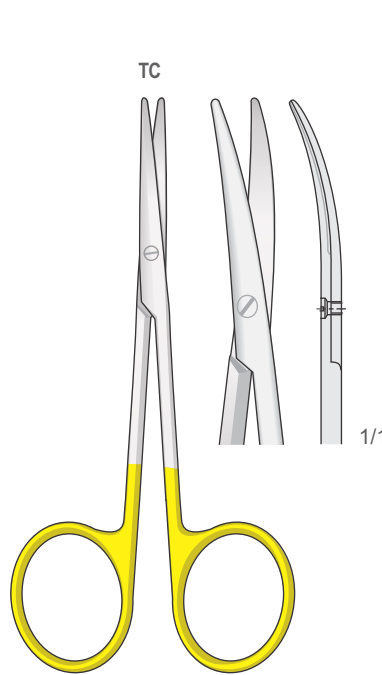


Scheren  
Scissors  
Forbici  
Tijeras  
Ciseaux

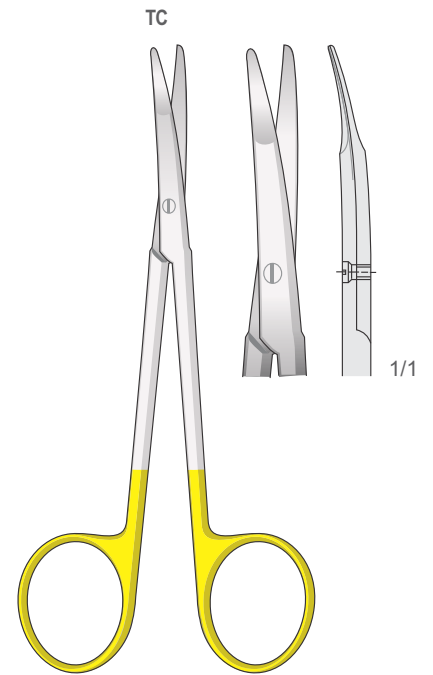
**Tungsten-Carbide Inserts**  
Mit Hartmetalleinsätzen  
Plaquettes en carbure de tungstène  
Plaquetas de carburo de tungsteno  
Inserti in carburo di tungsteno



LEXER-BABY (KNAPP)  
NMI-FM-1 18 15 mm  
1

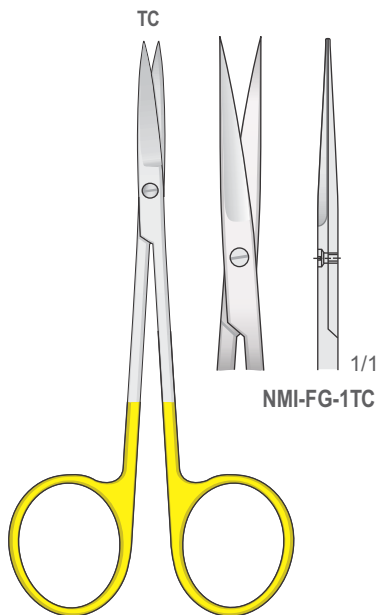


LEXER-BABY (KNAPP)  
NMI-FM-1 19 15 mm  
1

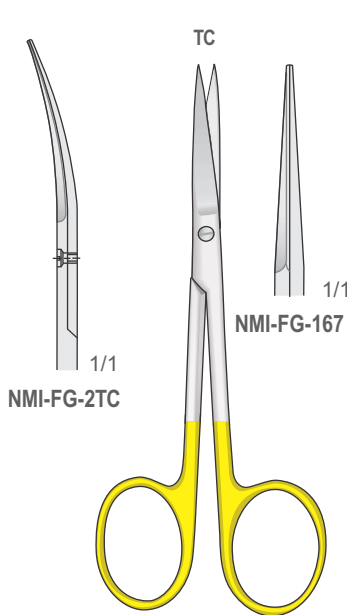


KILNER  
NMI-FM-350  
125 mm

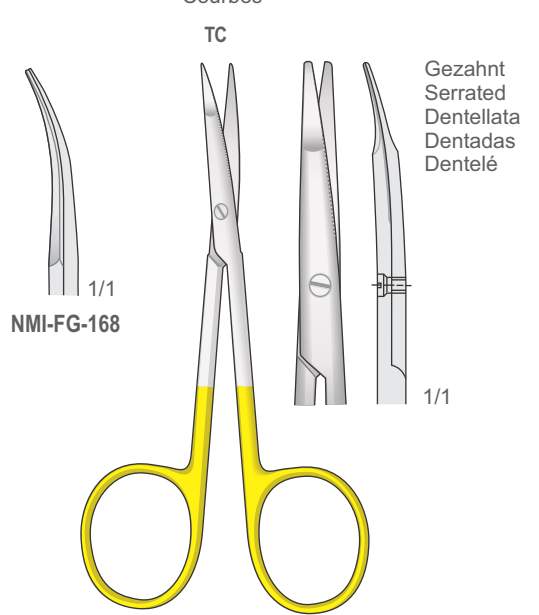
Gebogen - Curved  
Curva - Curvas  
Courbes



IRIS  
NMI-FG-1TC/NMI-FG-2TC  
1

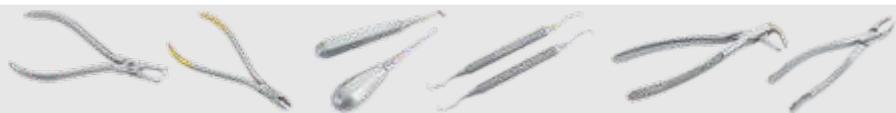


15 mm  
NMI-FG-167/NMI-FG-168  
1

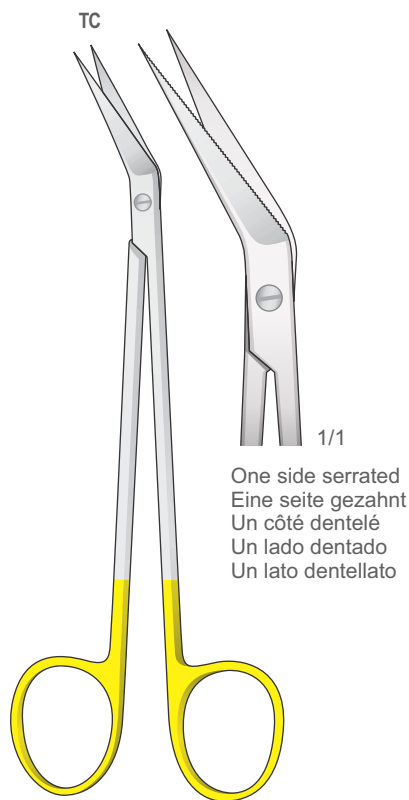


10 mm GREENBERG-PAR  
NMI-FM-317  
15 mm  
1

Gezahnt  
Serrated  
Dentellata  
Dentadas  
Dentelé

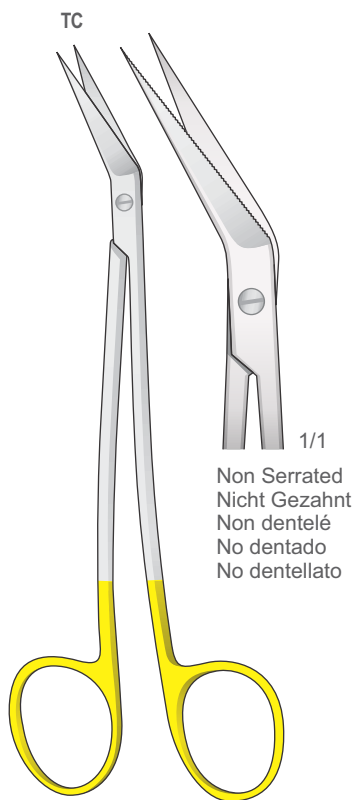


Scheren  
Scissors  
Forbici  
Tijeras  
Ciseaux



**NMI-LK-10**  
160 mm

One side serrated  
Eine seite gezahnt  
Un côté dentelé  
Un lado dentado  
Un lato dentellato

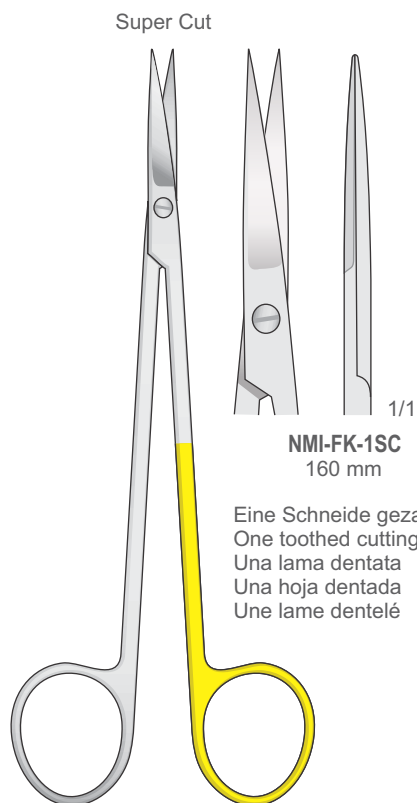


**NMI-LK-12**  
160 mm

Non Serrated  
Nicht Gezahnt  
Non dentelé  
No dentado  
No dentellato

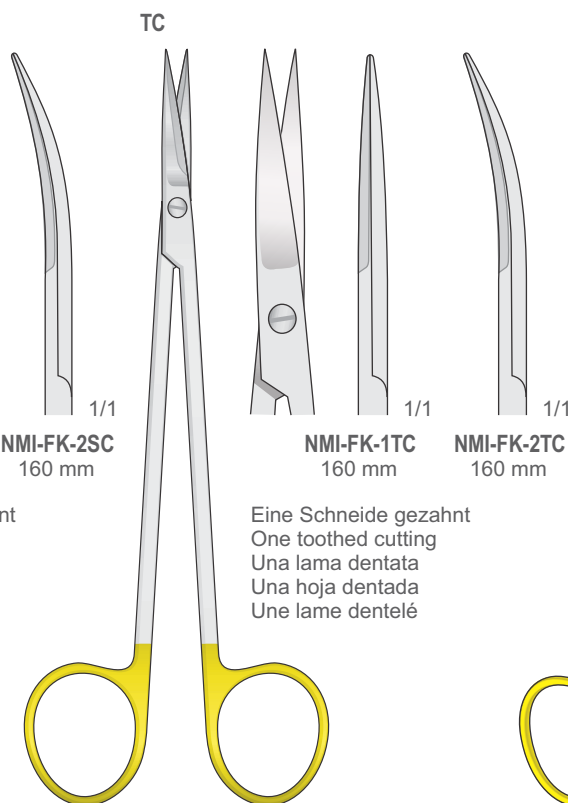
**Tungsten-Carbide Inserts**  
Mit Hartmetalleinsätzen  
Plaquettes en carbure de tungstène  
Plaquetas de carburo de tungsteno  
Inserti in carburo di tungsteno

Eine Schneide gezahnt S-förmig gebogen  
One toothed cutting edge S-shaped  
Una lama dentata curva a forma S  
Una hoja dentada forma S  
Une lame dentelée courbés en S



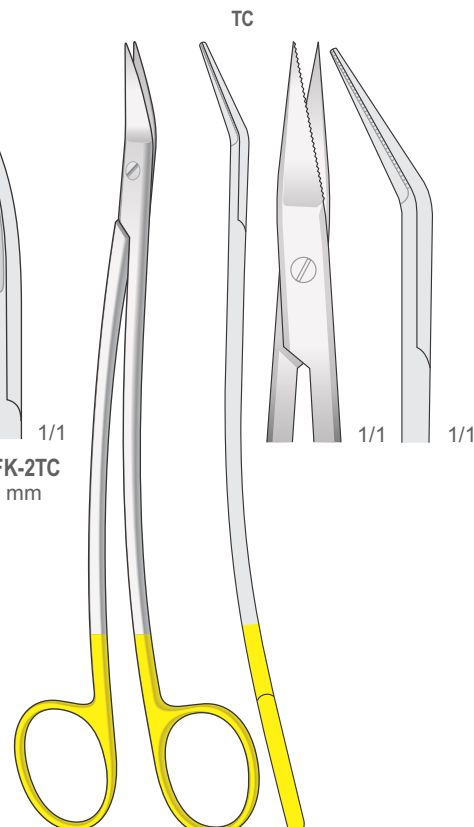
**KELLY**  
**NMI-FK-1SC/NMI-FK-2SC**  
160 mm

Eine Schneide gezahnt  
One toothed cutting  
Una lama dentata  
Una hoja dentada  
Une lame dentelé

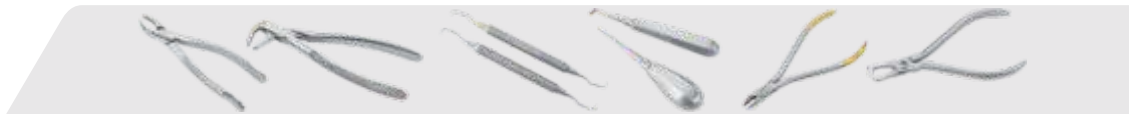


**KELLY**  
**NMI-FK-1TC / NMI-FK-2TC**  
160 mm

Eine Schneide gezahnt  
One toothed cutting  
Una lama dentata  
Una hoja dentada  
Une lame dentelé



**DEAN-TC**  
175 mm



Scheren  
Scissors  
Forbici  
Tijeras  
Ciseaux

Wellenschliff  
TC

Links Scheren  
Left Scissors  
Forbici per mancini  
Tijeras para zurdos  
Gauche Ciseaux

IRIS  
NMI-FM-100L  
1

10 mm

**Tungsten-Carbide Inserts**  
Mit Hartmetalleinsätzen  
Plaquettes en carbure de tungstène  
Plaquetas de carburo de tungsteno  
Inserti in carburo di tungsteno

Wellenschliff  
TC

IRIS  
NMI-FM-100  
1

10 mm

Wellenschliff  
TC

METZENBAUM  
NMI-FM-102  
145 mm

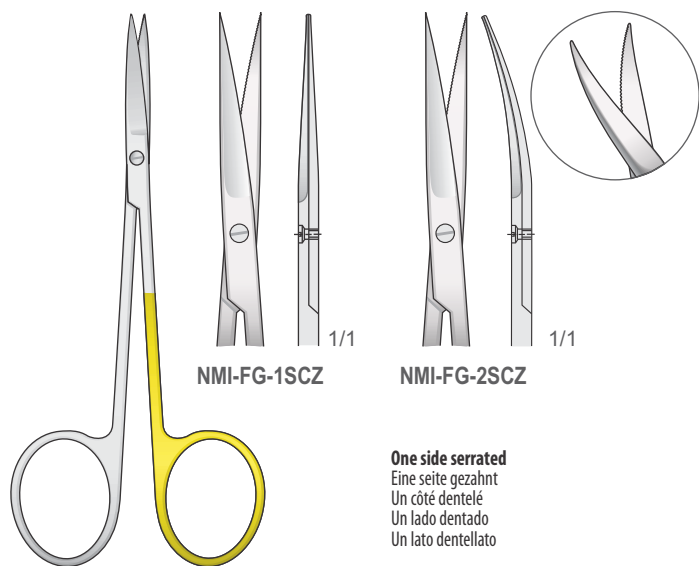
Wellenschliff  
TC

METZENBAUM  
NMI-FM-104  
185 mm



Scheren  
Scissors  
Forbici  
Tijeras  
Ciseaux

**Extremely Sharp Razor Edge / Atraumatic**  
Extrem Scharfe Spitzer Beck / Atraumatische  
Tranchant extrêmement aiguïssée / Atraumatique  
Borde extremadamente alado / Atraumática  
Taglio estremamente alato / Atraumatica



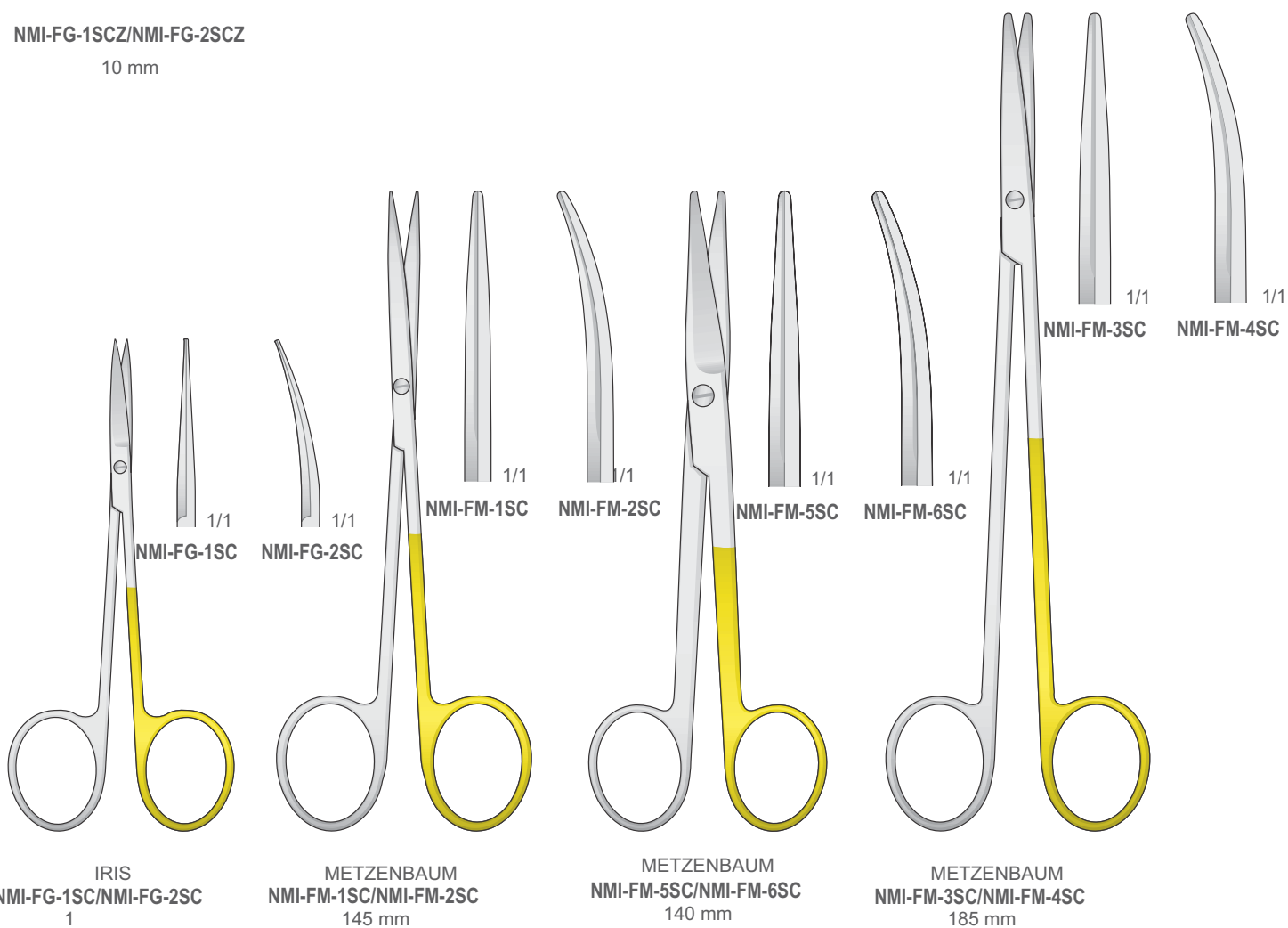
NMI-FG-1SCZ

NMI-FG-2SCZ

**One side serrated**  
Eine seite gezahnt  
Un côté dentelé  
Un lado dentado  
Un lato dentellato

NMI-FG-1SCZ/NMI-FG-2SCZ

10 mm



NMI-FG-1SC

NMI-FG-2SC

NMI-FM-1SC

NMI-FM-2SC

NMI-FM-5SC

NMI-FM-6SC

NMI-FM-3SC

NMI-FM-4SC

IRIS  
NMI-FG-1SC/NMI-FG-2SC  
1

METZENBAUM  
NMI-FM-1SC/NMI-FM-2SC  
145 mm

METZENBAUM  
NMI-FM-5SC/NMI-FM-6SC  
140 mm

METZENBAUM  
NMI-FM-3SC/NMI-FM-4SC  
185 mm



**SUPER CUT**



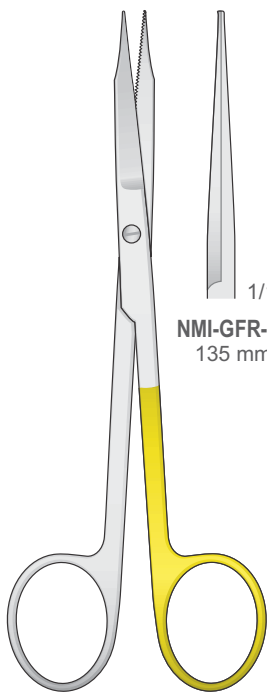
Super Cut Scissors have specially designed cutting edges.  
One regular edge and **one sharp-knife edge.**



**Extremely Sharp Razor Edge / Atraumatic**  
Extrem Scharfe Spitzer Beck / Atraumatische  
Tranchant extrêmement aiguisée / Atraumatique  
Borde extremadamente alado / Atraumática  
Taglio estremamente alato / Atraumatica

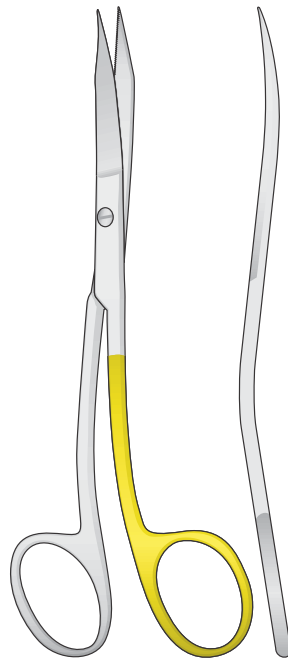


**One side serrated**  
Eine seite gezahnt  
Un côté dentelé  
Un lado dentado  
Un lato dentellato

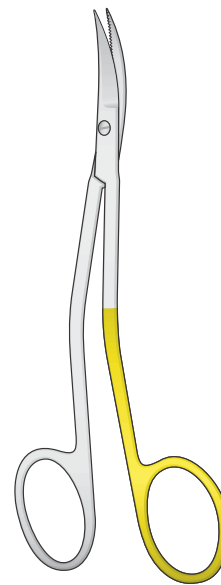


NMI-GFR-SC NMI-GFC-SC  
135 mm 135 mm

GOLDMAN-FOX  
NMI-GFR-SC/NMI-GFC-SC  
135 mm



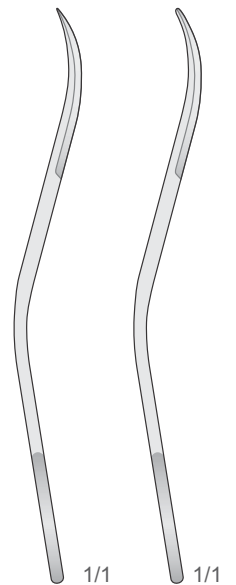
GOLDMAN-FOX S FORM  
GFS-SC  
130 mm



LA GRANGE  
NMI-LG-1SC/NMI-LG-2SC  
1

Spitz  
Sharp  
Acute  
Agudas  
Pointu

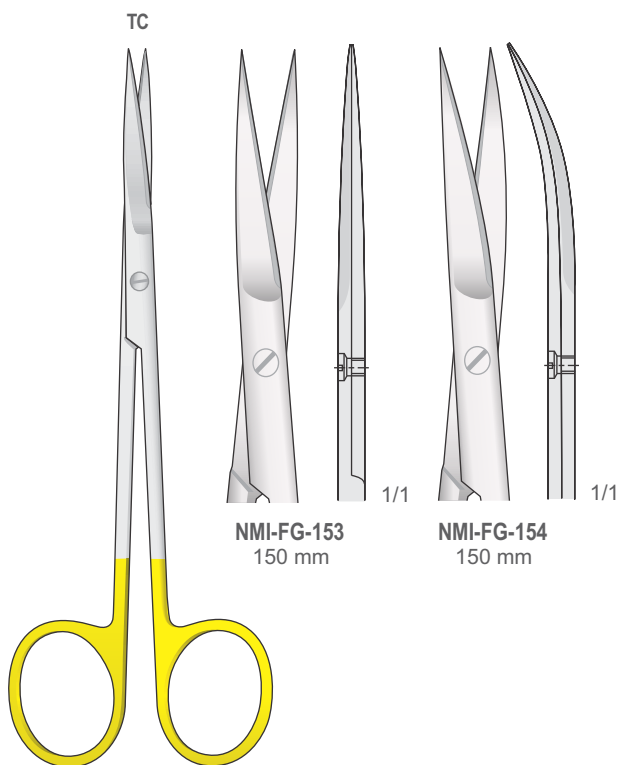
Stumpf  
Blunt  
Smusse  
Romas  
Mousse



LA GRANGE  
NMI-LG-1SC NMI-LG-2SC



Scheren  
Scissors  
Forbici  
Tijeras  
Ciseaux



JOSEPH  
NMI-FG-153/NMI-FG-154  
150 mm

**TC**  
TUNGSTEN  
CARBIDE

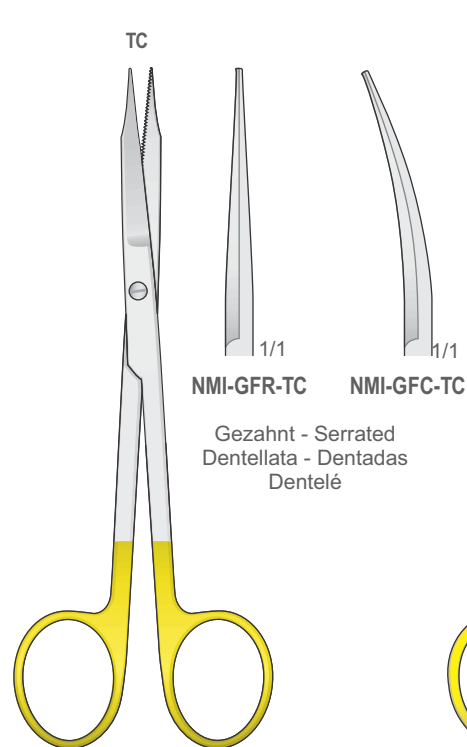
**Tungsten-Carbide Inserts**  
Mit Hartmetalleinsätzen  
Plaquettes en carbure de tungstène  
Plaquetas de carburo de tungsteno  
Inserti in carburo di tungsteno

**ONE SIDE  
SERRATED**

**One side serrated**  
Eine seite gezahnt  
Un côté dentelé  
Un lado dentado  
Un lato dentellato

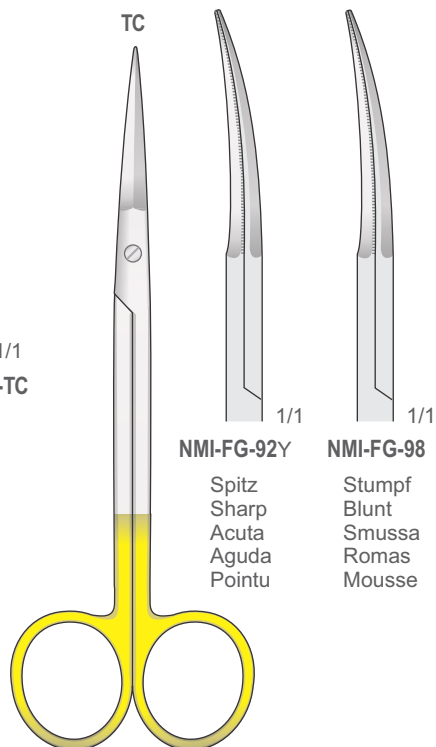
**ONE SIDE  
SERRATED**

**One side serrated**  
Eine seite gezahnt  
Un côté dentelé  
Un lado dentado  
Un lato dentellato



GOLDMAN-FOX  
NMI-GFC-TC/NMI-GFR-TC  
135 mm

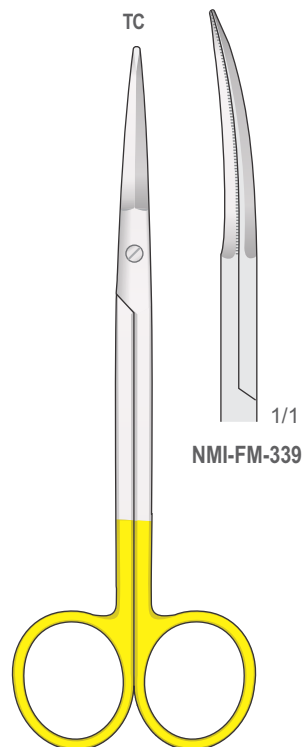
Gezahnt - Serrated  
Dentellata - Dentadas  
Dentelé



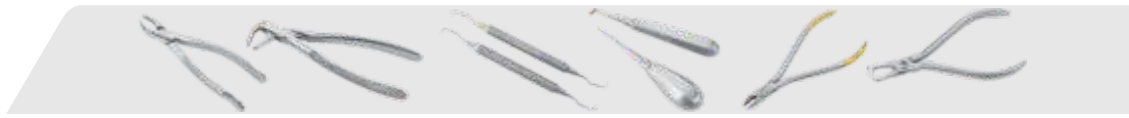
PECK-JOSEPH  
NMI-FG-92/NMI-FG-98  
140 mm

NMI-FG-92Y      NMI-FG-98

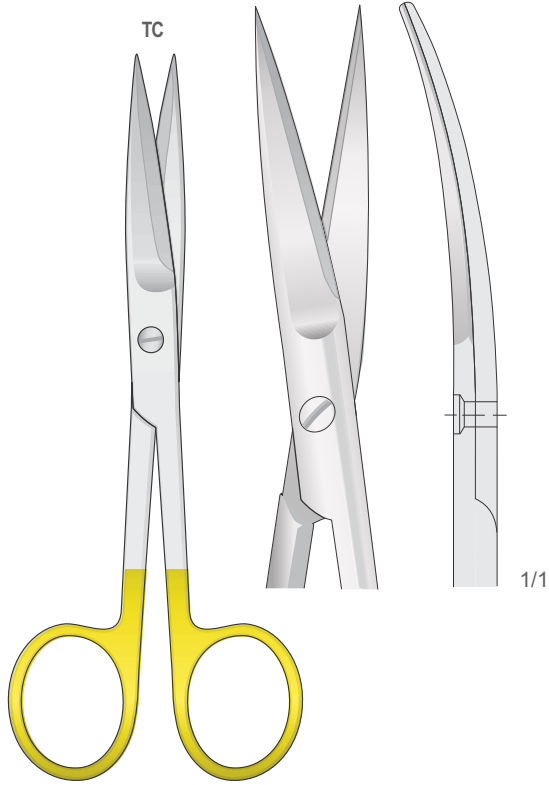
Spitz      Stumpf  
Sharp      Blunt  
Acuta      Smussa  
Aguda      Romas  
Pointu      Mousse



GREGOR  
NMI-FM-339  
140 mm



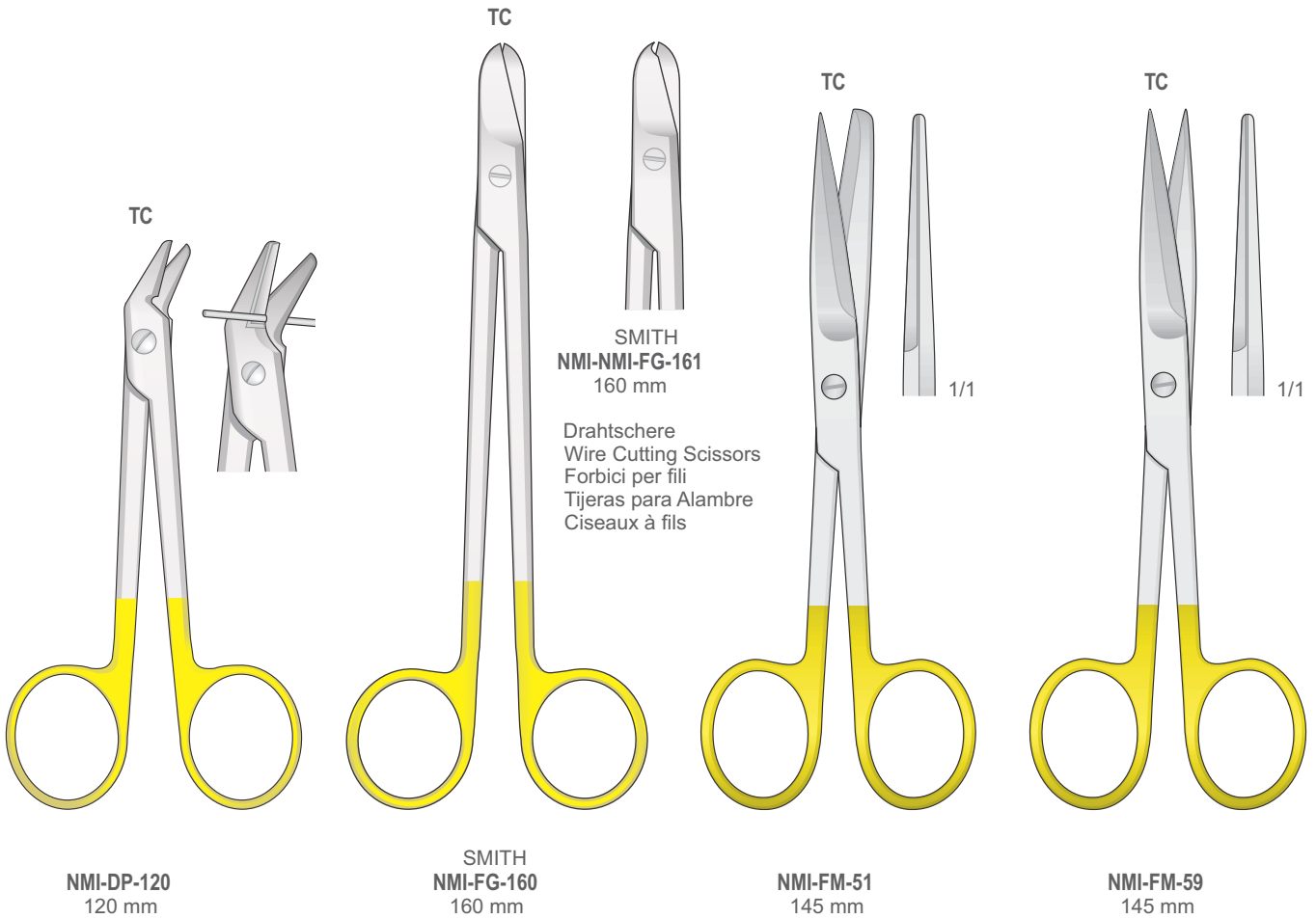
Scheren  
Scissors  
Forbici  
Tijeras  
Ciseaux



**TC**  
TUNGSTEN  
CARBIDE

**Tungsten-Carbide Inserts**  
Mit Hartmetalleinsätzen  
Plaquettes en carbure de tungstène  
Plaquetas de carburo de tungsteno  
Inserti in carburo di tungsteno

**NMI-FM-146**  
145 mm



**NMI-DP-120**  
120 mm

**SMITH  
NMI-FG-160**  
160 mm

**NMI-FM-51**  
145 mm

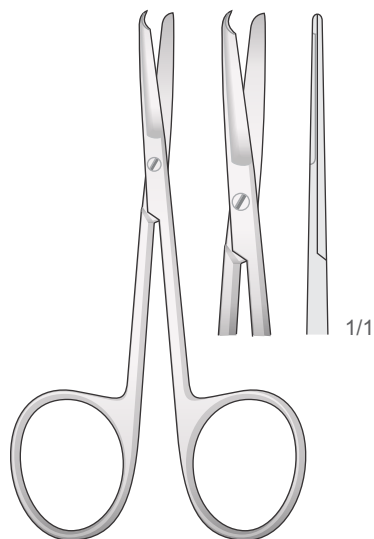
**NMI-FM-59**  
145 mm

**SMITH  
NMI-NMI-FG-161**  
160 mm

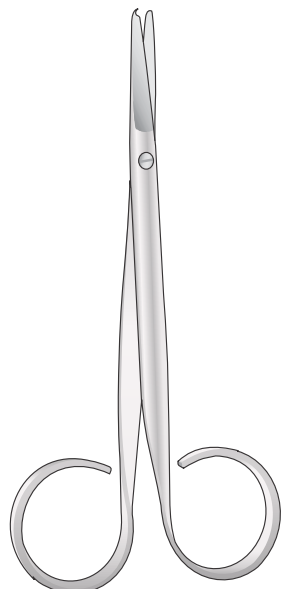
Drahtschere  
Wire Cutting Scissors  
Forbici per fili  
Tijeras para Alambre  
Ciseaux à fils



Ligatur Scheren  
Ligature Scissors  
Forbici per legature  
Tijeras para ligaduras  
Ciseaux à ligatures

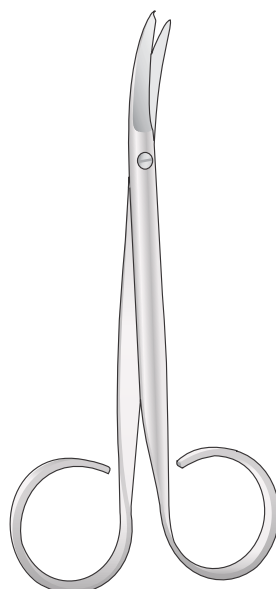


SPENCER  
NMI-SC-9  
90 mm



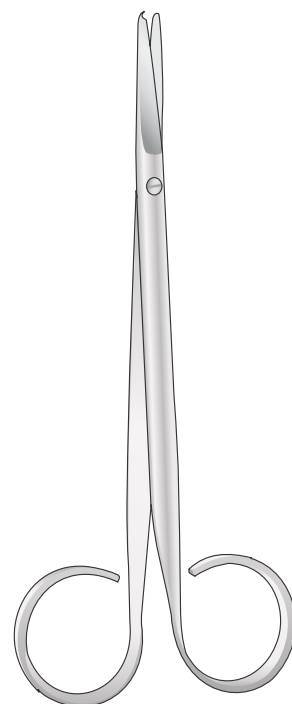
SPENCER  
NMI-SC-1  
1

10 mm

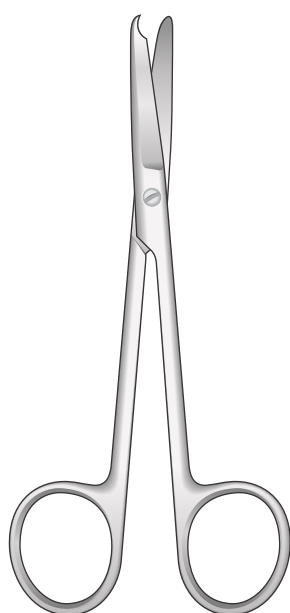


SPENCER  
NMI-SC-5  
1

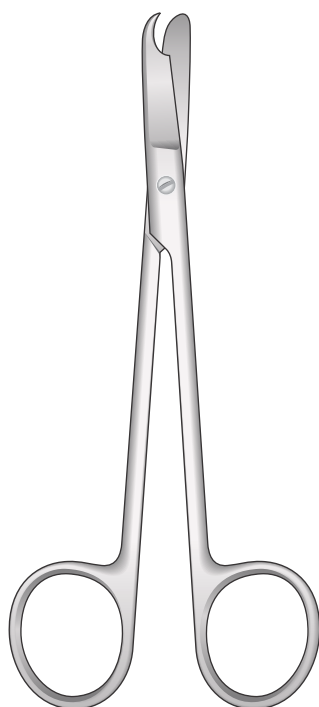
10 mm



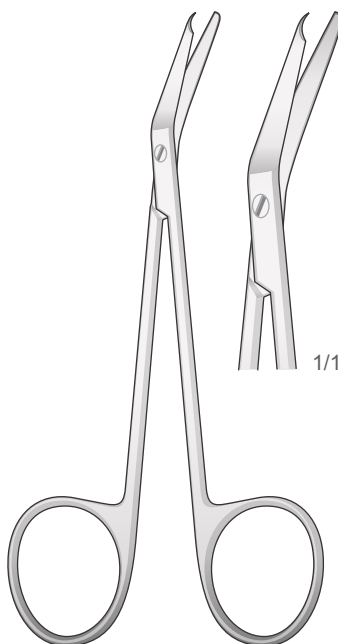
SPENCER  
NMI-SC-2  
145 mm



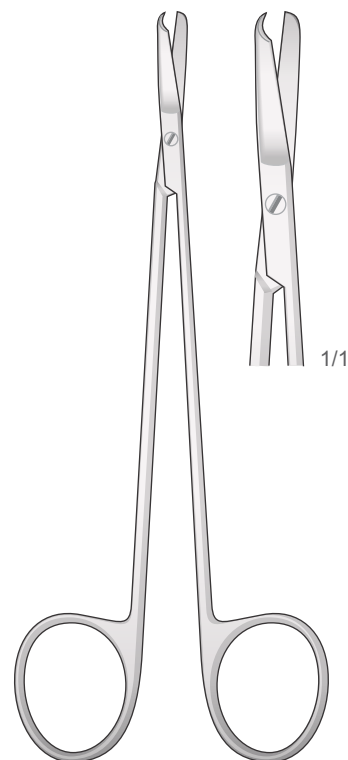
SPENCER  
NMI-SC-14  
120 mm



LITTAUER  
NMI-SC-15  
140 mm



SPENCER  
NMI-SC-13  
130 mm

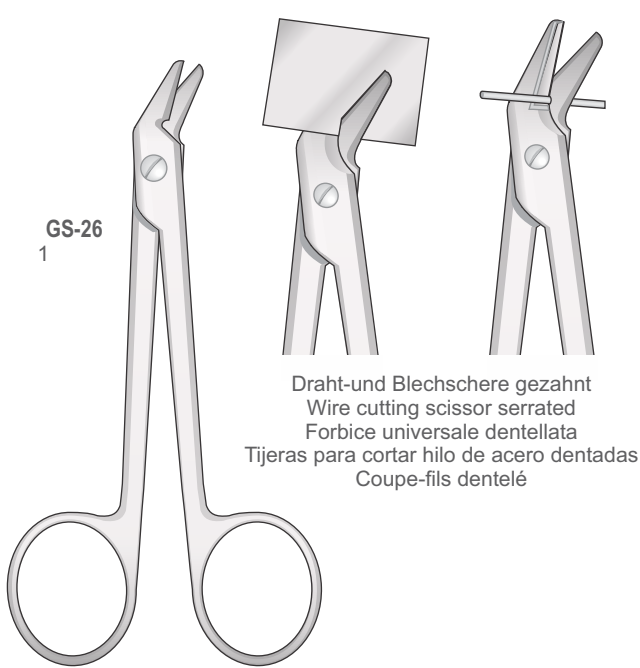


KELLY  
NMI-SC-16  
150 mm



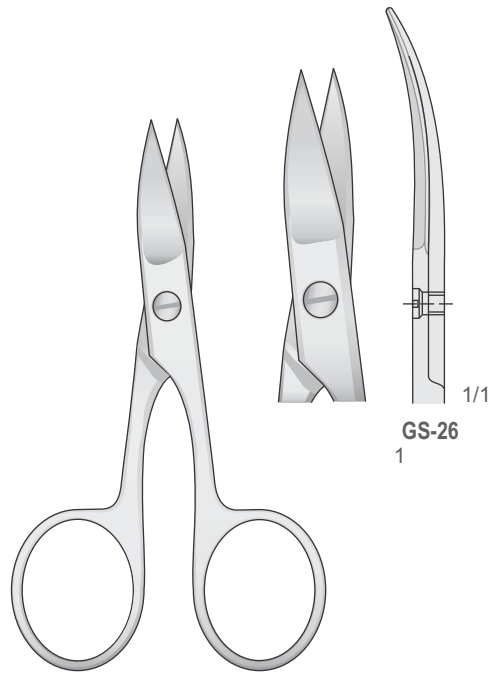
Draht und blehscheren  
Wire and plate cutting scissors  
Forbici per fili metallici  
Tijeras para cortar alambre  
Ciseaux coupe-fils métalliques

10 mm 10 mm



**GS-26**  
1

Draht-und Blehschere gezahnt  
Wire cutting scissor serrated  
Forbice universale dentellata  
Tijeras para cortar hilo de acero dentadas  
Coupe-fils dentelé

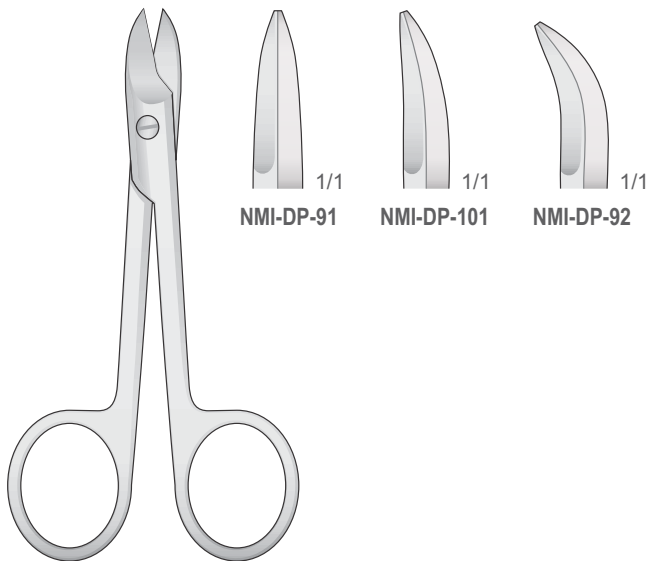


**GS-26**  
1

**NMI-DP-90**  
120 mm

Spitz  
Sharp  
Acute  
Agudas  
Pointu

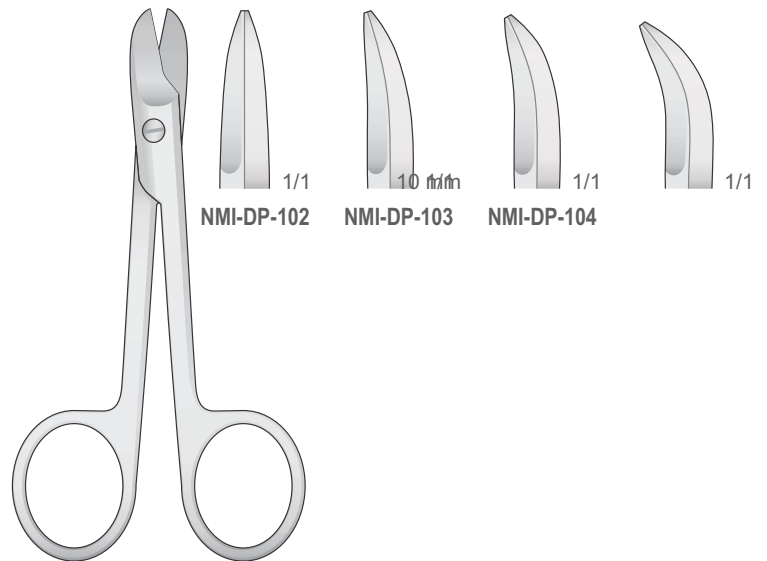
Stumpf  
Blunt  
Smusse  
Romas  
Mousse



**NMI-DP-91**

**NMI-DP-101**

**NMI-DP-92**



**NMI-DP-102**

**NMI-DP-103**

**NMI-DP-104**

BEEBE  
**NMI-DP-91/NMI-DP-101**  
1

# DENTAL Instruments

Extracting Forceps

Root Elevators

Scalpel Blades and Handles

Surgical Scissors

Tissue and Dressing Forceps

Needle Holders

Hemostatic Forceps | Towel Clamps

Retractors | Mouth Gags

Implantology

Periosteal | Curettes | Rongeurs

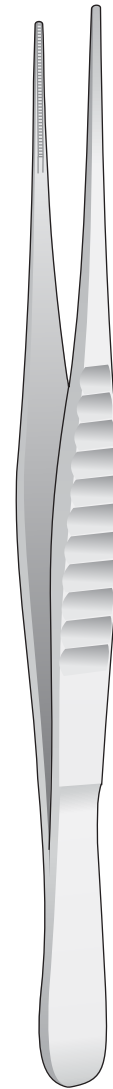
Dental Restoration | Periodontology

Suction Tube

Orthodontics

Crown Instruments | Laboratory

Instrument Maintenance | Sterilization



110-136

**Tissue and Dressing Forceps**

Chirurgische und Anatomische Pinzetten

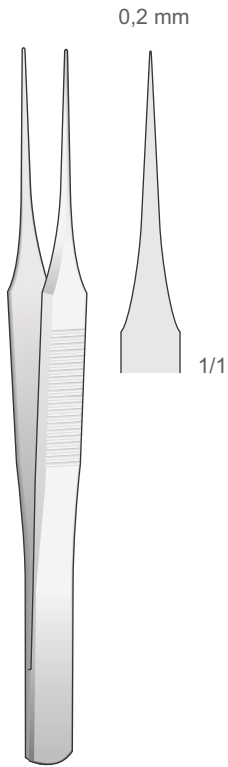
Pinces à tissu et à pansement

Pinzas quirúrgicas y anatómicas

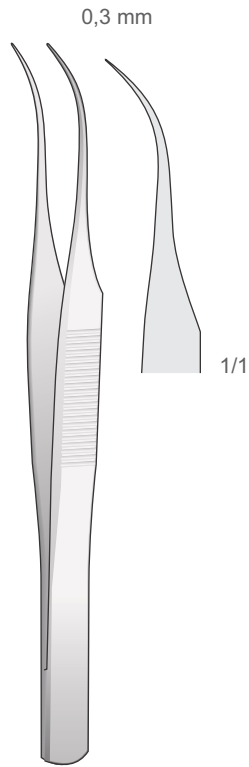
Pinzette chirurgiche e anatomiche



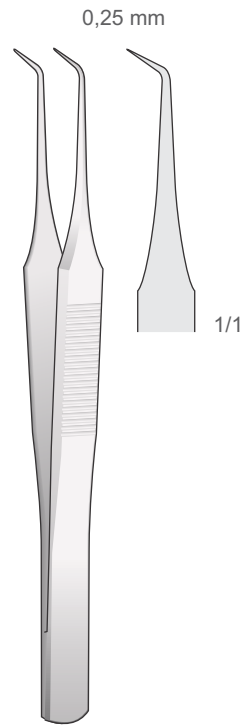
Mikro Pinzetten  
Delicate Forceps  
Micro Pinzette  
Pinzas finas  
Micro Pincers



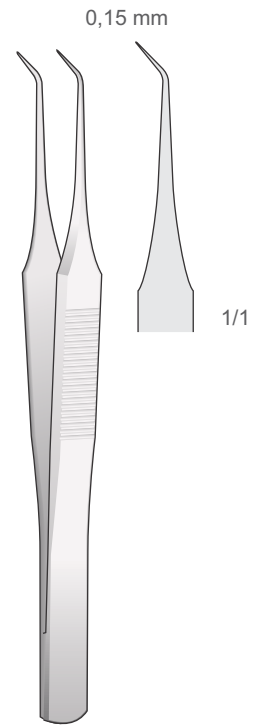
**NMI-BD-360**  
100 mm



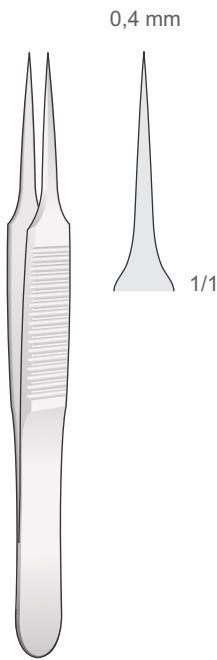
**NMI-BD-361**  
100 mm



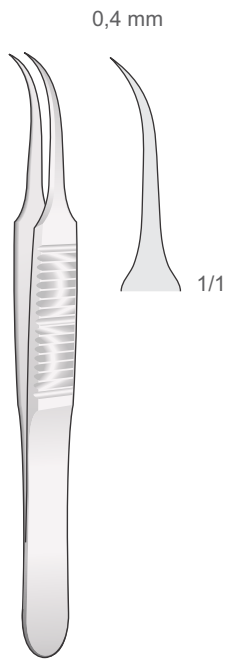
**NMI-BD-362**  
100 mm



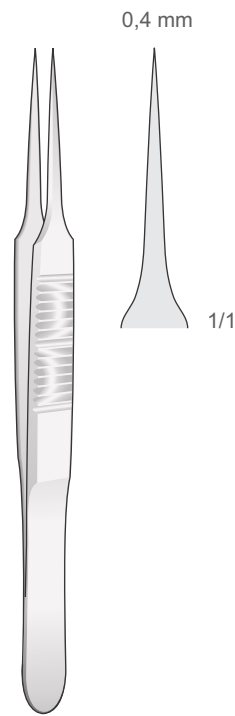
**NMI-BD-363**  
100 mm



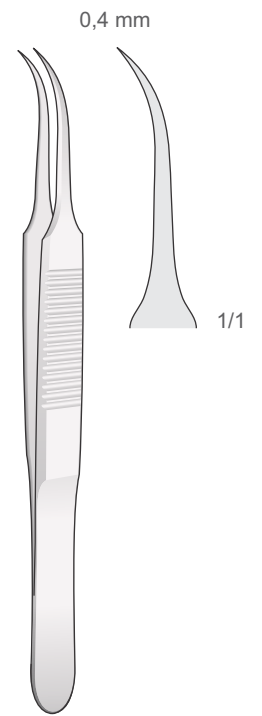
**NMI-BD-364** 10 mm  
1



**NMI-BD-365**  
10 mm 1



**NMI-BD-366**  
130 mm



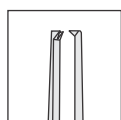
**NMI-BD-367**  
130 mm



Mikro Pinzetten  
Delicate Forceps  
Micro Pinzette  
Pinzas finas  
Micro Pincers

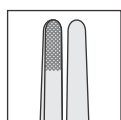
**Diamond Tip**  
Diamantiert  
Punta diamantata  
Punta de diamante  
Pointe de diamant

Tissue Forceps  
1x2 Teeth



BISHOP-HARMON  
NMI-MF-177 1,2 mm  
85 mm

Dressing Forceps  
criss-cross serrated tips



BISHOP-HARMON  
NMI-MF-249 1,2 mm  
85 mm



1/1

1x2 Zähne  
1x2 Teeth  
1x2 Denti  
1x2 Dientes  
1x2 Dents



CASTROVIEJO  
NMI-BD-348 0,9 mm  
120 mm



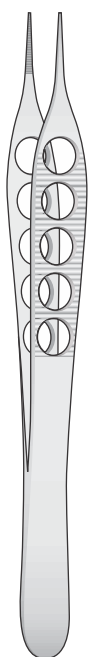
1/1

9x9 Zähne  
9x9 Teeth  
9x9 Denti  
9x9 Dientes  
9x9 Dents

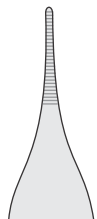


BROWN  
NMI-BD-349  
120 mm

1,2 mm

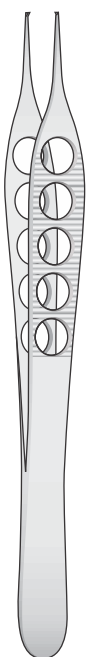


ADSON  
NMI-BD-207  
120 mm

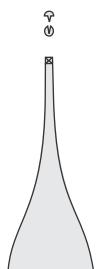


1/1

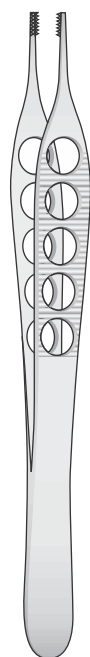
1,2 mm



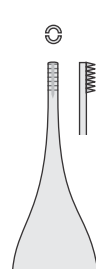
ADSON  
NMI-BD-208  
120 mm



1/1



ADSON-BROWN  
NMI-BD-209  
120 mm

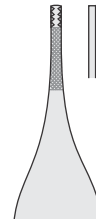


1/1

7x7 Zähne  
7x7 Teeth  
7x7 Denti  
7x7 Dientes  
7x7 Dents



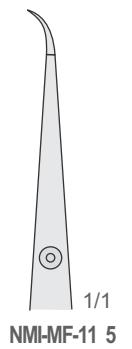
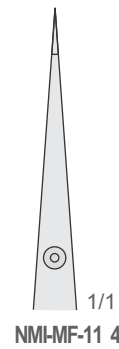
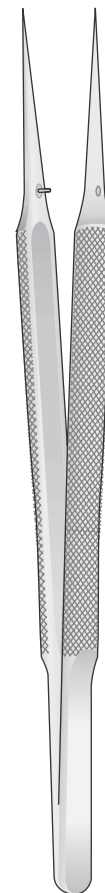
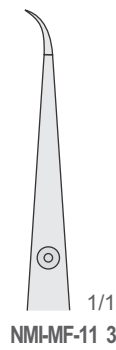
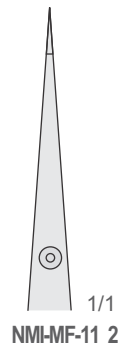
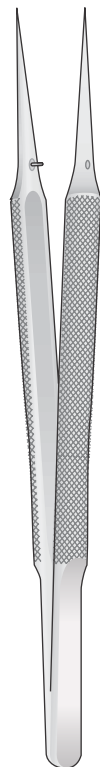
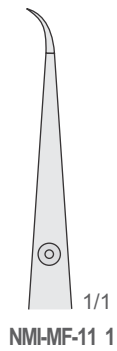
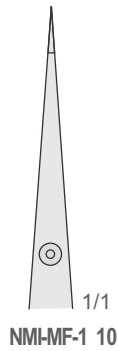
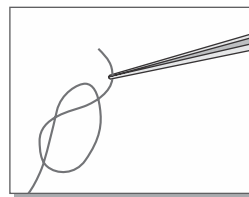
ADSON-BROWN  
NMI-BD-253  
120 mm



1/1



Mikro Pinzetten  
Delicate Forceps  
Micro Pinzette  
Pinzas finas  
Micro Pincers



NMI-MF-110/NMI-MF-111  
120 mm

NMI-MF-112/NMI-MF-113  
150 mm

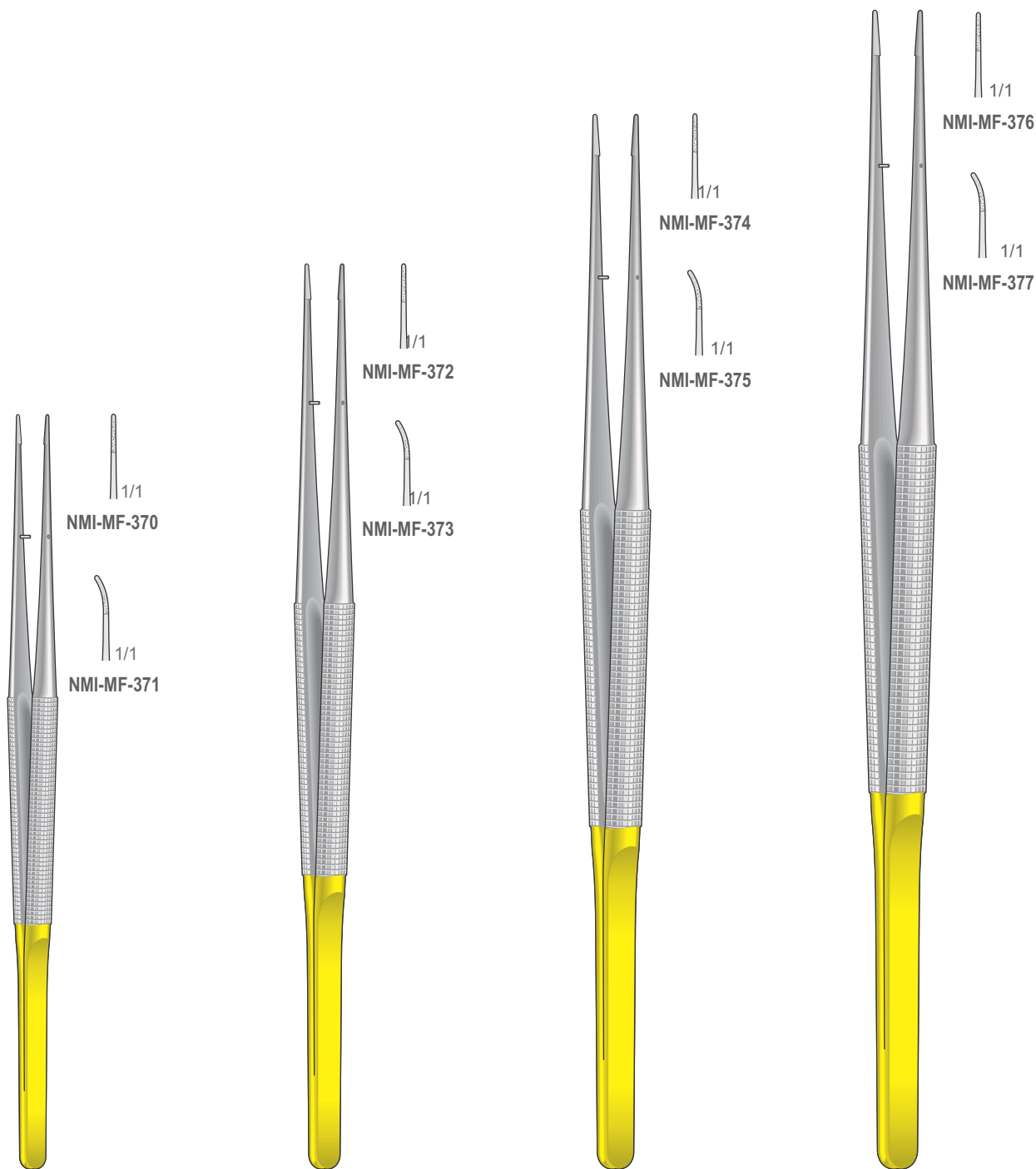
NMI-MF-114/NMI-MF-115  
180 mm



Mikro Pinzette - Rundgriff Ø 8 mm  
Mit Führungsstift diamantiert  
Fadenplatte 6x0,7 mm

Mikro Pinzetten  
Micro Forceps  
Micro Pinzette  
Micro Pinzas  
Micro Pincas

**Diamond Tip**  
Diamantiert  
Punta diamantata  
Punta de diamante  
Pointe de diamant



NMI-MF-370/NMI-MF-371  
150 mm

NMI-MF-372/NMI-MF-373  
180 mm

NMI-MF-374/NMI-MF-375  
210 mm

NMI-MF-376/NMI-MF-377  
230 mm



Mikro Pinzetten  
Micro Forceps  
Micro Pinzette  
Micro Pinzas  
Micro Pincas

Mikro Pinzette - Rundgriff Ø 8 mm  
Mit Führungsstift diamantiert  
Fadenplatte 6x0,7 mm

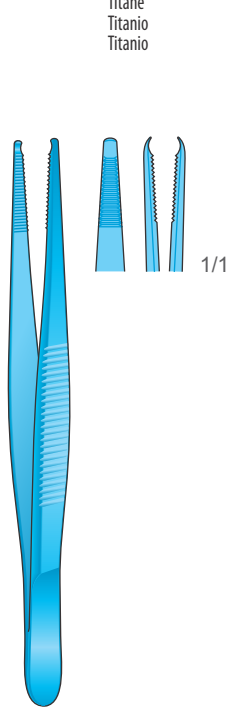
**Diamond Tip**  
Diamantiert  
Punta diamantata  
Punta de diamante  
Pointe de diamant

<p>1x2 Zähne 1x2 Teeths 1x2 Denti 1x2 Dientes 1x2 Dents</p> <p>NMI-MF-378 1/1 NMI-MF-379 1/1</p>	<p>1x2 Zähne 1x2 Teeths 1x2 Denti 1x2 Dientes 1x2 Dents</p> <p>NMI-MF-380 1/1 NMI-MF-381 1/1</p>	<p>1x2 Zähne 1x2 Teeths 1x2 Denti 1x2 Dientes 1x2 Dents</p> <p>NMI-MF-382 1/1 NMI-MF-383 1/1</p>	<p>1x2 Zähne 1x2 Teeths 1x2 Denti 1x2 Dientes 1x2 Dents</p> <p>NMI-MF-384 1/1 NMI-MF-385 1/1</p>
<p>NMI-MF-378/NMI-MF-379 150 mm</p>	<p>NMI-MF-380/NMI-MF-381 180 mm</p>	<p>NMI-MF-382/NMI-MF-383 210 mm</p>	<p>NMI-MF-384/NMI-MF-385 230 mm</p>

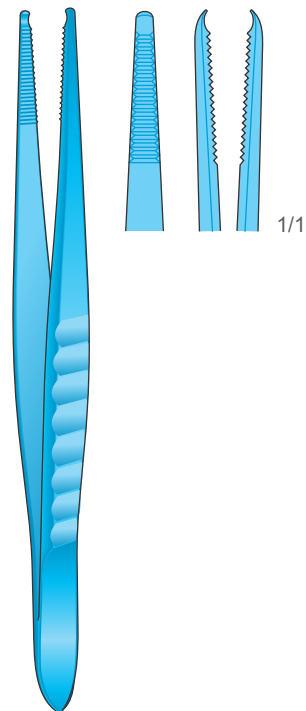


Titan-Pinzetten  
Titanium Tissue Forceps  
Pinzette in titanio  
Pinzas de titanio  
Pincas en titane

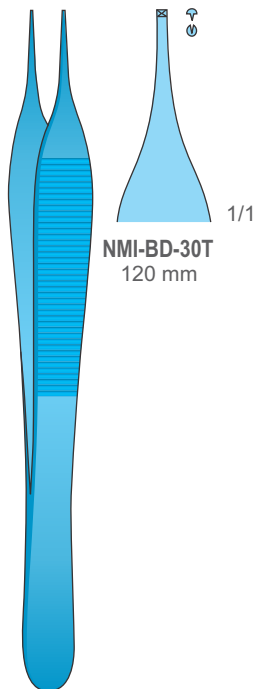
Titanium  
Titan  
Titane  
Titanio  
Titano



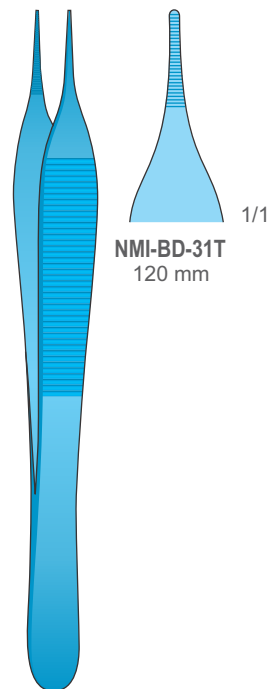
**NMI-BD-285T**  
90 mm



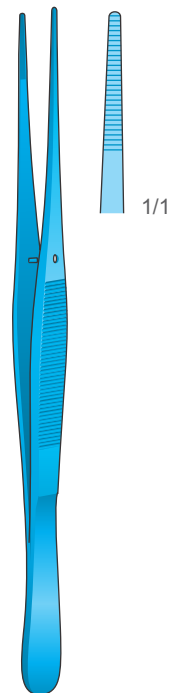
**NMI-BD-270T**  
130 mm



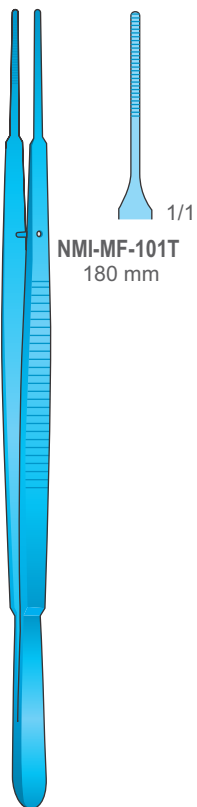
ADSON  
**NMI-BD-30T**  
120 mm



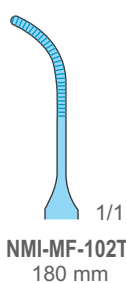
ADSON  
**NMI-BD-31T**  
120 mm



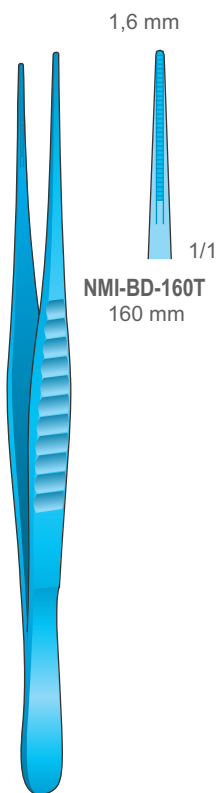
**NMI-BD-09T**  
130 mm



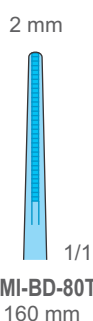
GERALD  
**NMI-MF-101T/NMI-MF-102T**  
180 mm



**NMI-MF-102T**  
180 mm



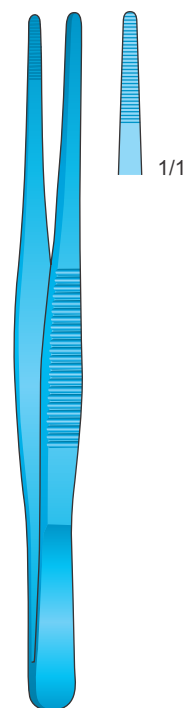
DE BAKEY  
**NMI-BD-80T/NMI-BD-160T**



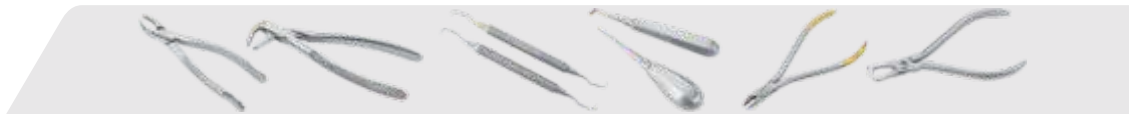
**NMI-BD-80T**  
160 mm



NMI-COLLEGE  
**NMI-TT-01**  
150 mm

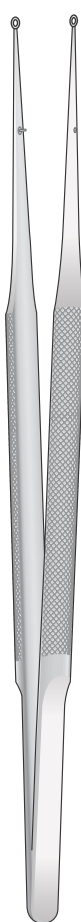






**NMI-BD-75T**  
145 mm



Mikro Pinzetten  
Delicate Forceps  
Micro Pinzette  
Pinzas finas  
Micro Pincas

Rund-Griffe Ø 8 mm  
Round handle Ø 8 mm  
Manico rotondo Ø 8 mm  
Mango redondo Ø 8 mm  
Manche rond Ø 8 mm

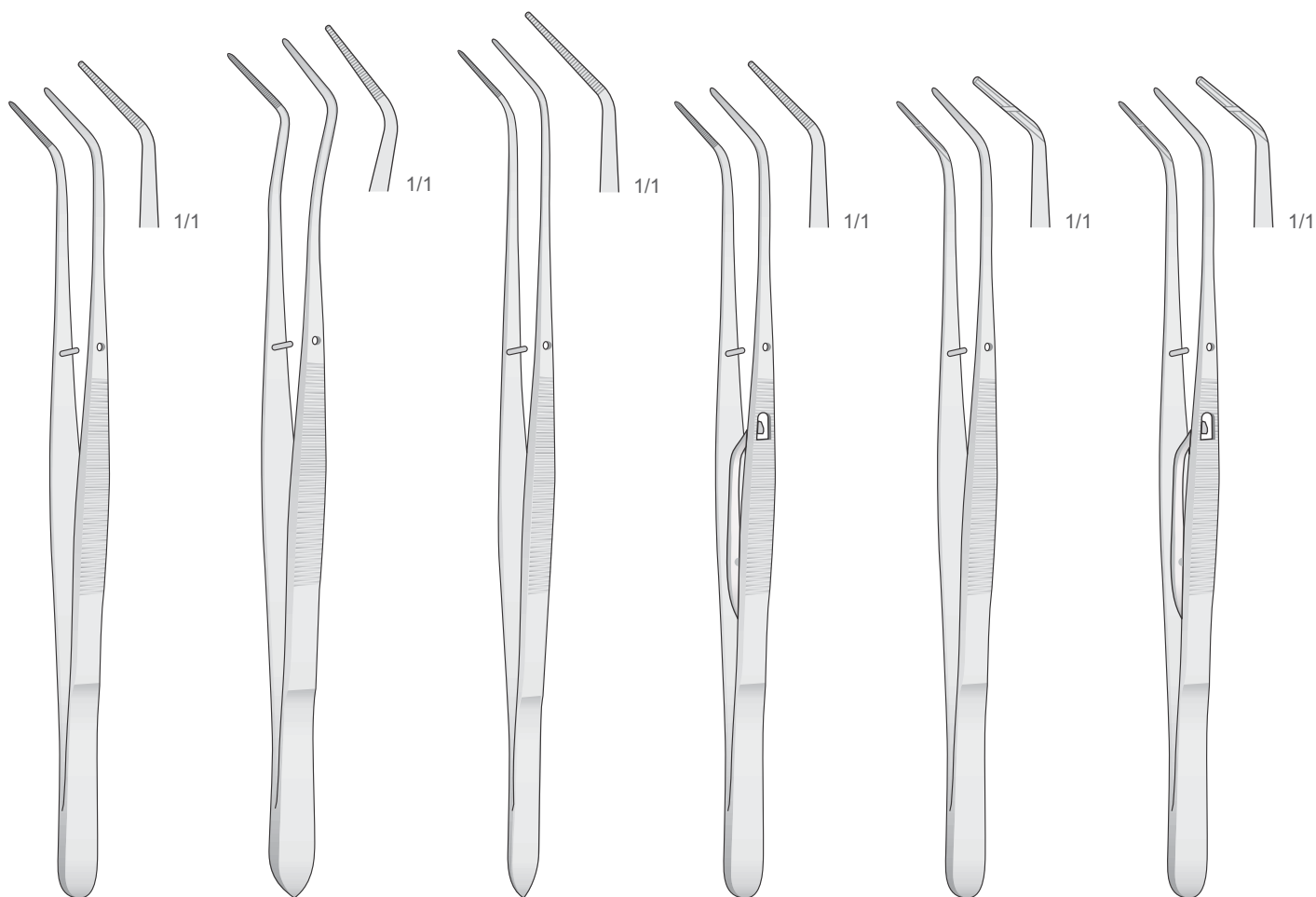
	Ø 1 mm	Ø 2 mm	Titan Titanium Titanio Titanio Titane	Ø 1 mm	Ø 2 mm	
						
	<b>NMI-MF-124</b> - 150 mm	<b>NMI-MF-127</b> - 150 mm		<b>NMI-MF-142T</b> - 150 mm	<b>NMI-MF-145T</b> - 150 mm	
	<b>NMI-MF-125</b> - 180 mm	<b>NMI-MF-128</b> - 180 mm		<b>NMI-MF-143T</b> - 180 mm	<b>NMI-MF-146T</b> - 180 mm	
	<b>NMI-MF-126</b> - 210 mm	<b>NMI-MF-129</b> - 210 mm		<b>NMI-MF-144T</b> - 210 mm	<b>NMI-MF-147T</b> - 210 mm	
						<b>Titanium</b> Titan Titane Titanio Titanio

NMI-MF-124/NMI-MF-129

NMI-MF-142T/NMI-MF-147T



Zahnpinzetten  
Cotton and Dressing Pliers  
Pinzette per medicazione  
Pinzas para vendajes  
Précelles pour cotton



**NMI-COLLEGE**  
150 mm

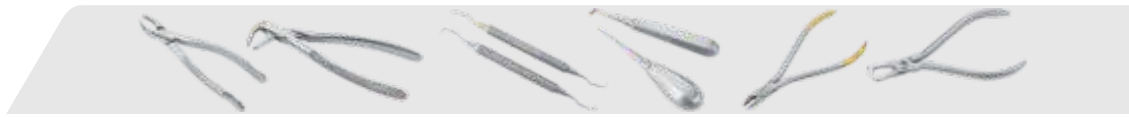
**NMI-MERIAM**  
160 mm

**NMI-FALGG**  
160 mm

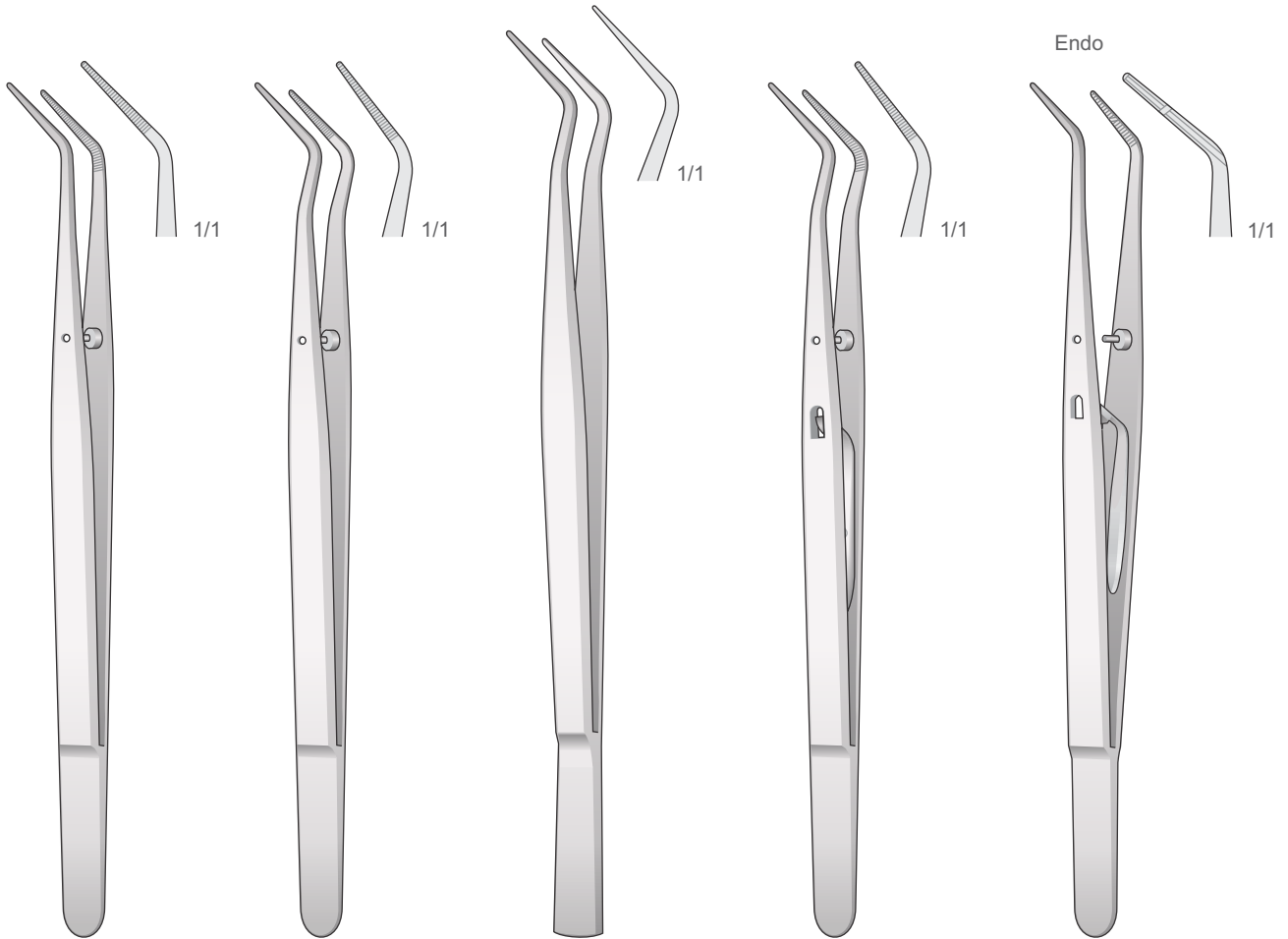
**NMI-COLLEGE-S**  
150 mm

**NMI-DA-04**  
150 mm

**NMI-DA-05**  
150 mm



Zahnpinzetten  
Cotton and Dressing Pliers  
Pinzette per medicazione  
Pinzas para vendajes  
Précèlles pour cotton



**NMI-COLLEGE**  
**NMI-BD-01** Fig.17  
150 mm

**NMI-MERIAM**  
**NMI-BD-02** Fig.18  
150 mm

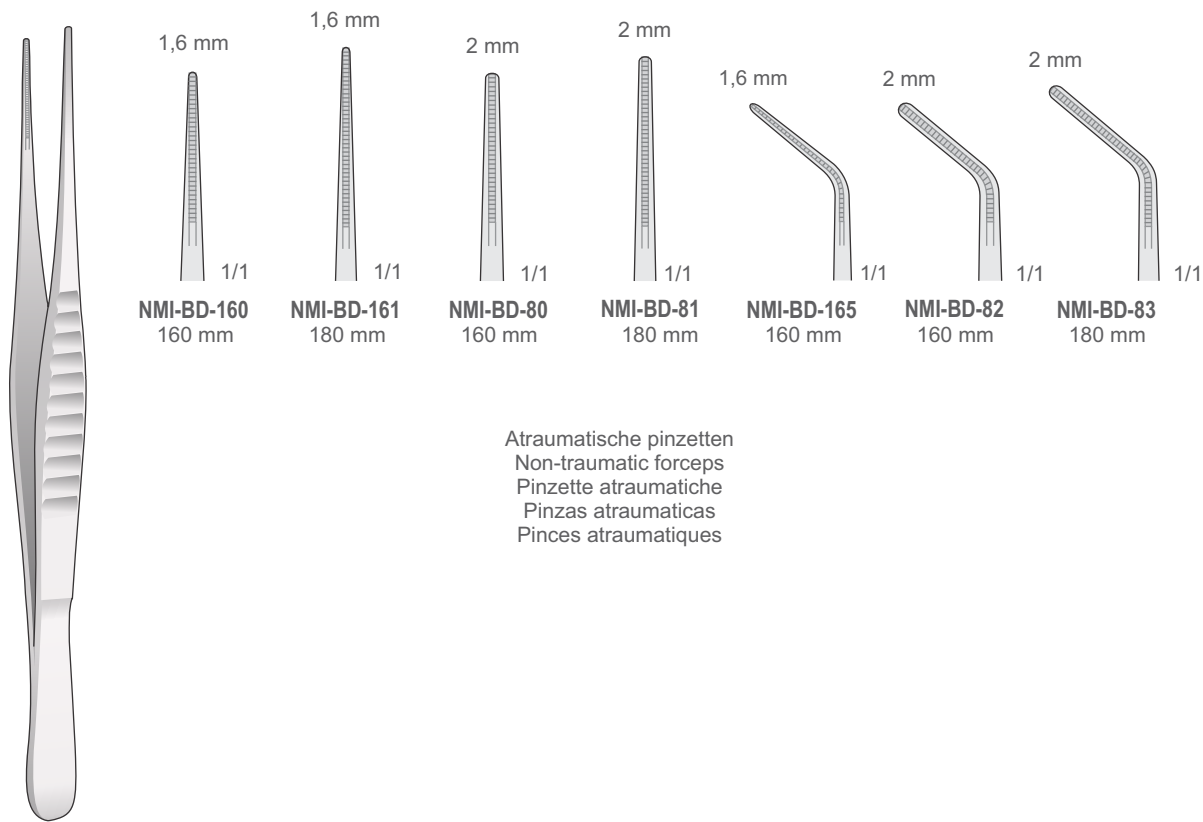
**CAULK**  
**NMI-BD-1** 1  
160 mm

**LOCKING**  
**NMI-BD-03** Fig.18L  
150 mm

**NMI-DA-09**  
Endo  
150 mm



Chirurgische und Anatomische Pinzetten  
Tissue and Dressing Forceps  
Pinzette anatomiche e chirurgiche  
Pinzas de diseccion y quirúrgicas  
Pinces anatomiques chirurgicales



**NMI-BD-160**  
160 mm

**NMI-BD-161**  
180 mm

**NMI-BD-80**  
160 mm

**NMI-BD-81**  
180 mm

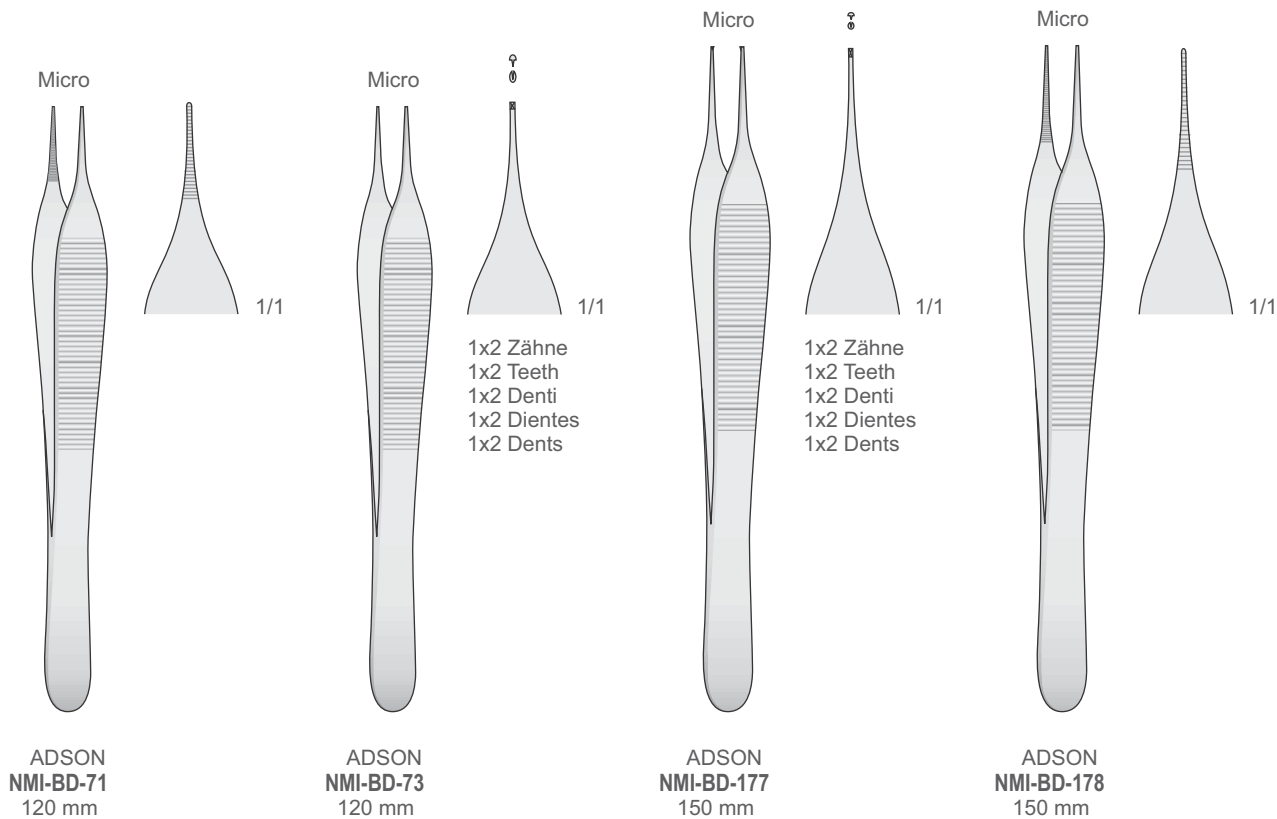
**NMI-BD-165**  
160 mm

**NMI-BD-82**  
160 mm

**NMI-BD-83**  
180 mm

Atraumatische pinzetten  
Non-traumatic forceps  
Pinzette atraumatiche  
Pinzas atraumaticas  
Pinces atraumatiques

DE BAKEY  
NMI-BD-80/NMI-BD-165



**ADSON**  
**NMI-BD-71**  
120 mm

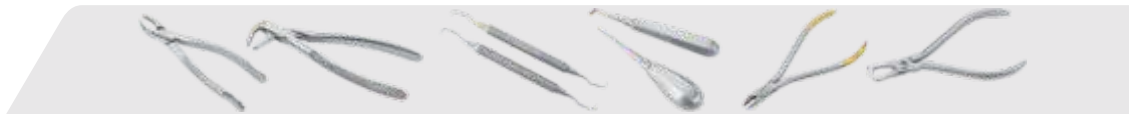
**ADSON**  
**NMI-BD-73**  
120 mm

**ADSON**  
**NMI-BD-177**  
150 mm

**ADSON**  
**NMI-BD-178**  
150 mm

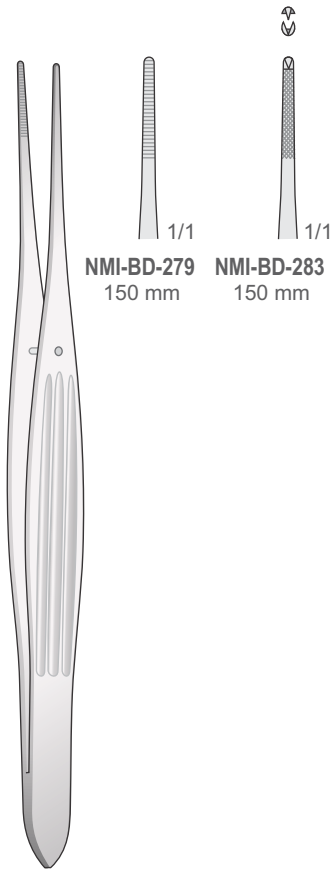
1x2 Zähne  
1x2 Teeth  
1x2 Denti  
1x2 Dientes  
1x2 Dents

1x2 Zähne  
1x2 Teeth  
1x2 Denti  
1x2 Dientes  
1x2 Dents

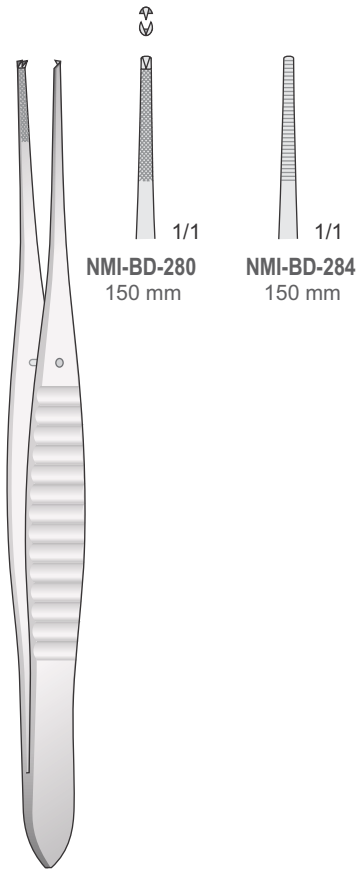


Chirurgische Pinzetten  
Tissue Forceps  
Pinzette chirurgiche  
Pinzas quirùrgicas  
Pincas chirurgicales

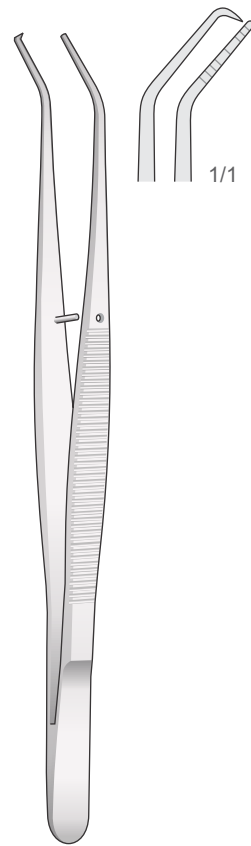
Taschenmarkierungspinzetten  
Pocket markers  
Pinzette segnatasche  
Pinzas para marcar el sulco periodontal  
Pincas à marquer la poche



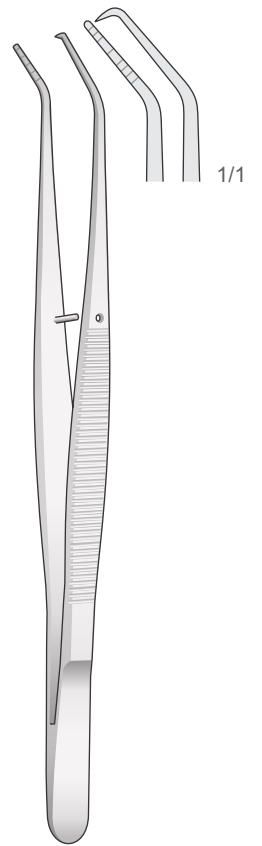
McINDOE  
NMI-BD-279/NMI-BD-283  
150 mm



GILLIES  
NMI-BD-280/NMI-BD-284  
150 mm



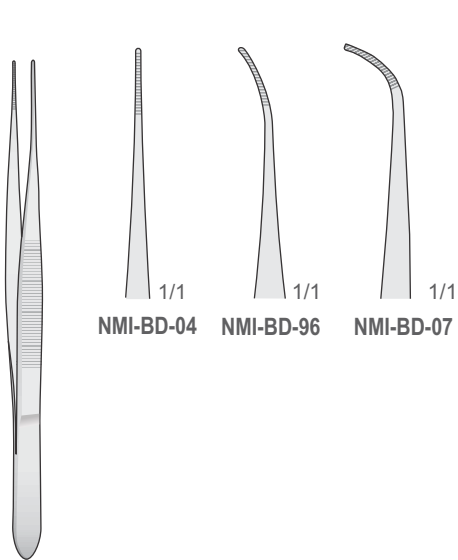
CRANE-CAPLAN  
NMI-DB-01  
150 mm



CRANE-CAPLAN  
NMI-DB-02  
150 mm

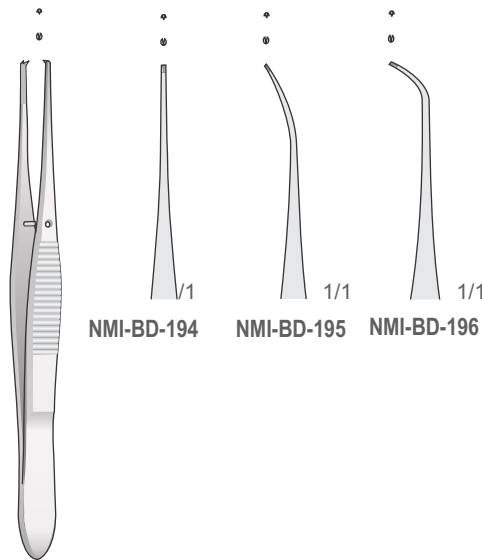


Chirurgische Pinzetten  
Tissue Forceps  
Pinzette chirurgiche  
Pinzas quirúrgicas  
Pincas quirúrgicas



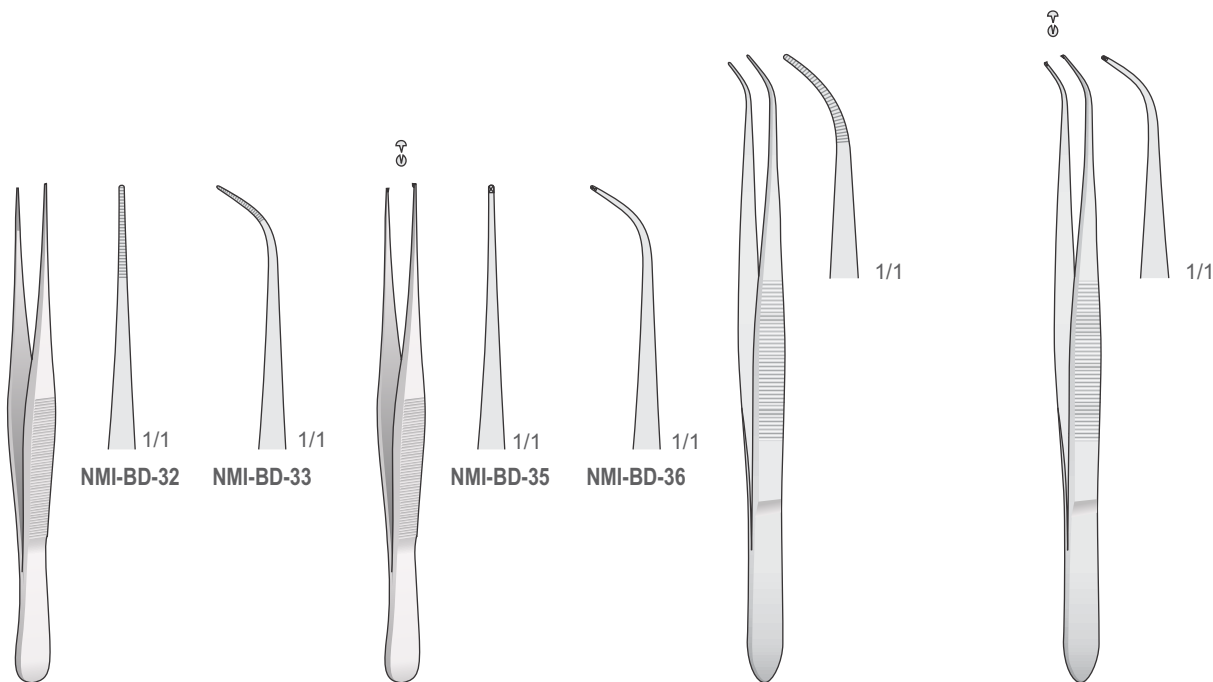
NMI-BD-04 NMI-BD-96 NMI-BD-07

GRAEFE  
NMI-BD-04/NMI-BD-96  
100 mm



NMI-BD-194 NMI-BD-195 NMI-BD-196

GRAEFE  
NMI-BD-194/NMI-BD-196  
100 mm



NMI-BD-32/NMI-BD-33  
100 mm

NMI-BD-35/NMI-BD-36  
100 mm

PERRY  
NMI-BD-05  
125 mm

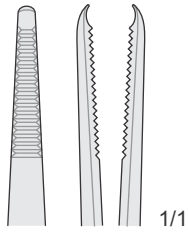
NMI-BD-06  
125 mm



Anatomische Pinzetten  
Dressing Forceps  
Pinzette anatomiche  
Pinzas de diseccion  
Pincas anatomiques



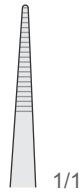
**NMI-BD-270**  
130 mm



1/1



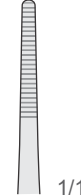
**NMI-BD-145**  
130 mm



1/1

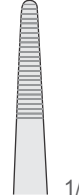


**NMI-BD-16/NMI-BD-148**  
160 mm



1/1

**NMI-BD-16**  
160 mm

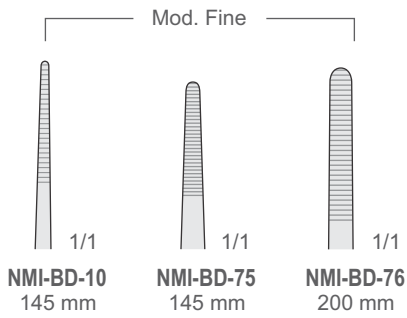


1/1

**NMI-BD-148**  
160 mm



**NMI-BD-10/NMI-BD-76**



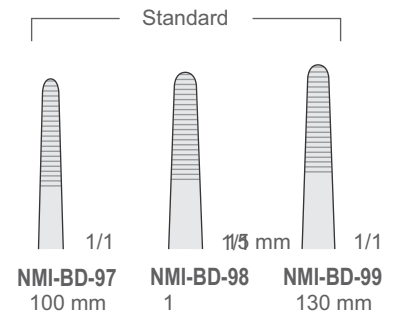
**NMI-BD-10**  
145 mm

**NMI-BD-75**  
145 mm

**NMI-BD-76**  
200 mm



**NMI-BD-97/NMI-BD-99**



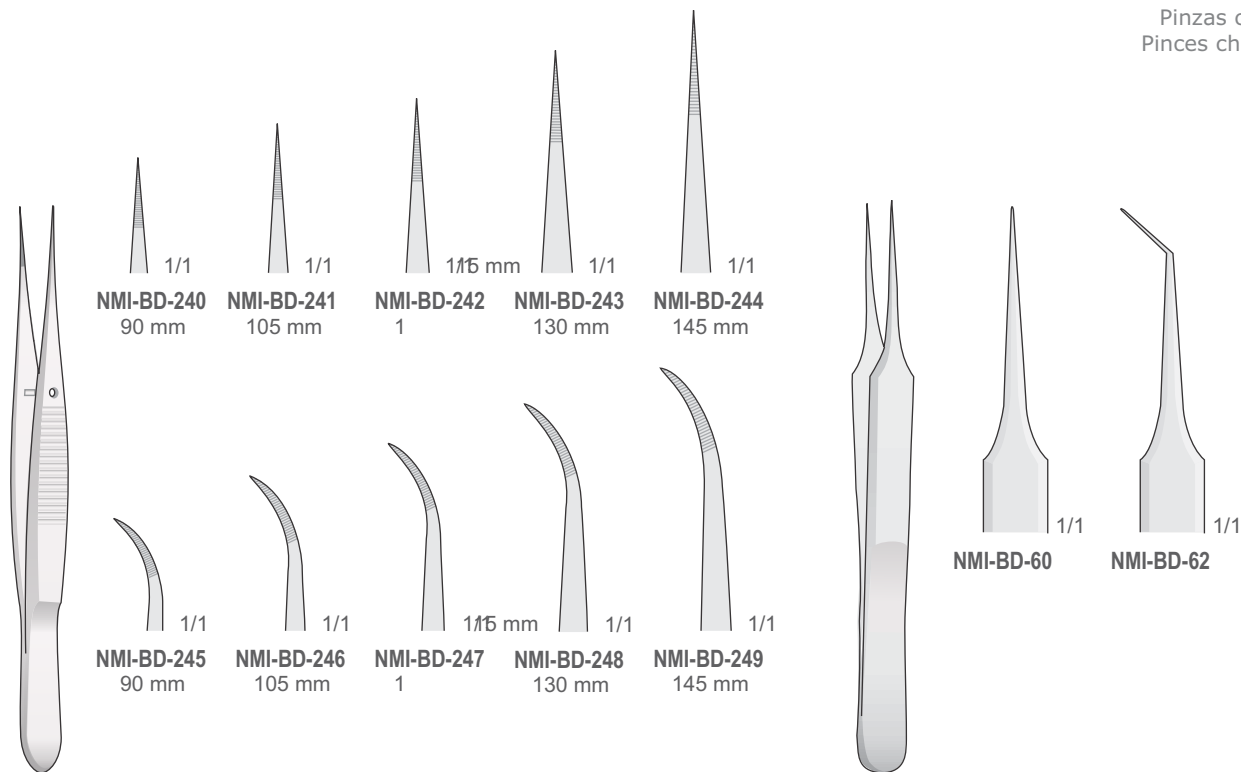
**NMI-BD-97**  
100 mm

**NMI-BD-98**  
1

**NMI-BD-99**  
130 mm

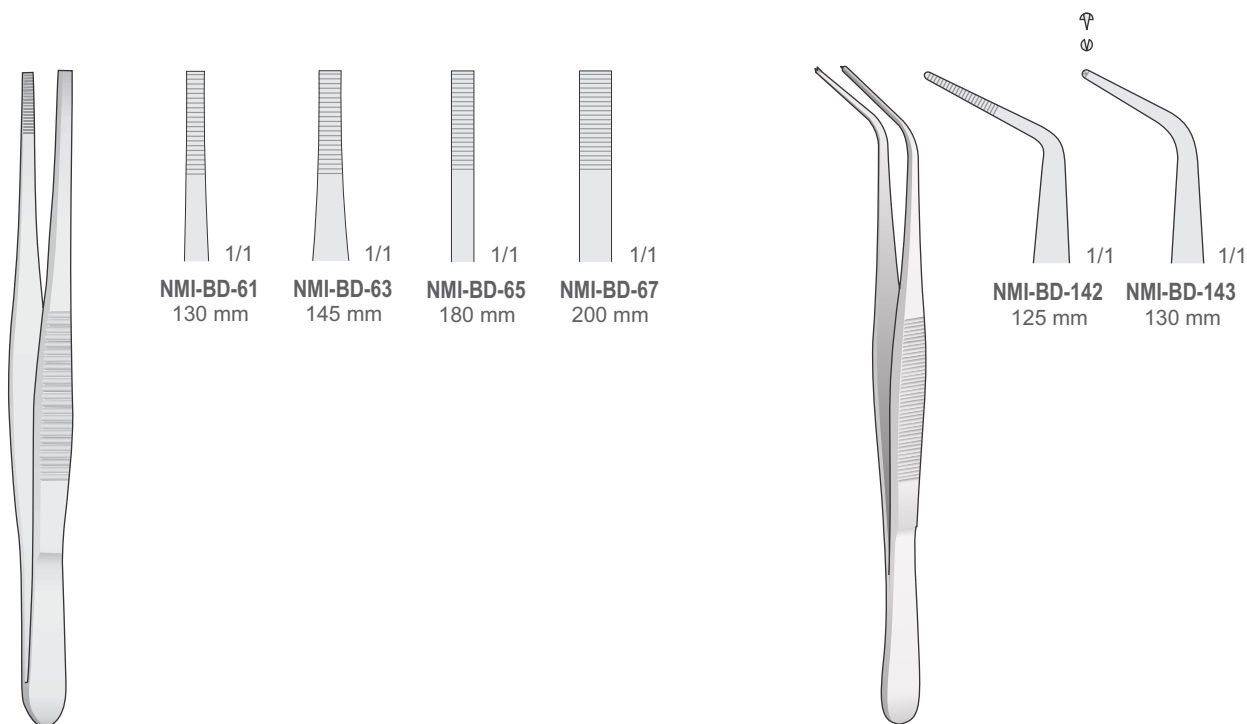


Chirurgische Pinzetten  
Tissue Forceps  
Pinzette chirurgiche  
Pinzas chirùrgicas  
Pincas chirurgicales



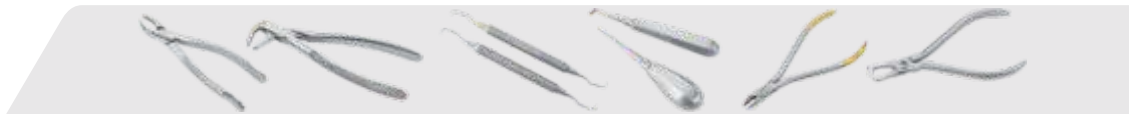
NMI-BD-240/NMI-BD-249

NMI-BD-60/NMI-BD-62 10 mm  
1



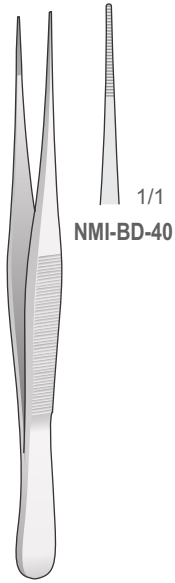
STILLE  
NMI-BD-61/NMI-BD-67

NMI-BD-142/NMI-BD-143

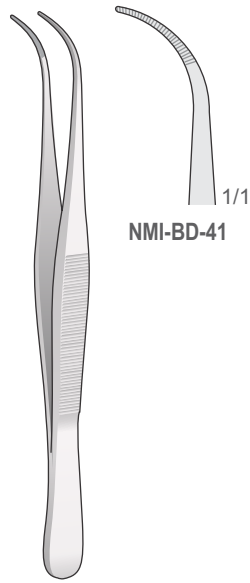


Chirurgische Pinzetten  
Tissue Forceps  
Pinzette chirurgische  
Pinzas quirúrgicas  
Pincas quirúrgicas

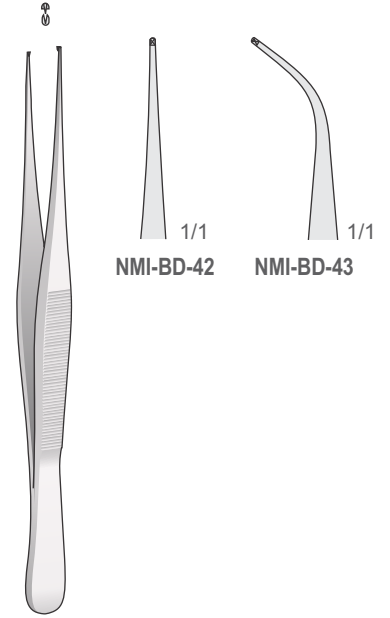
10 mm



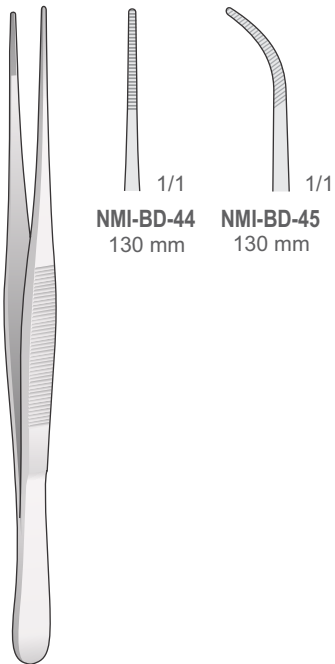
**NMI-BD-40**  
1



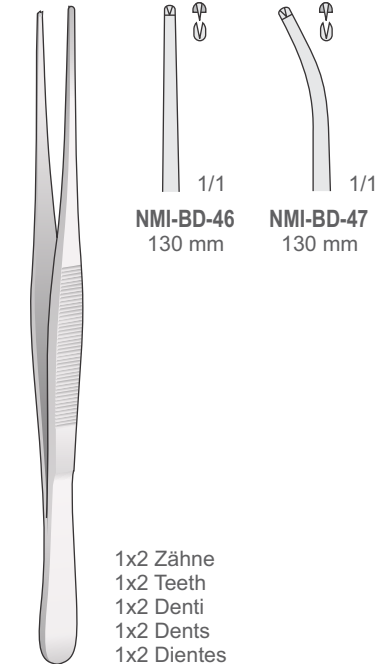
**NMI-BD-41** 10 mm  
1



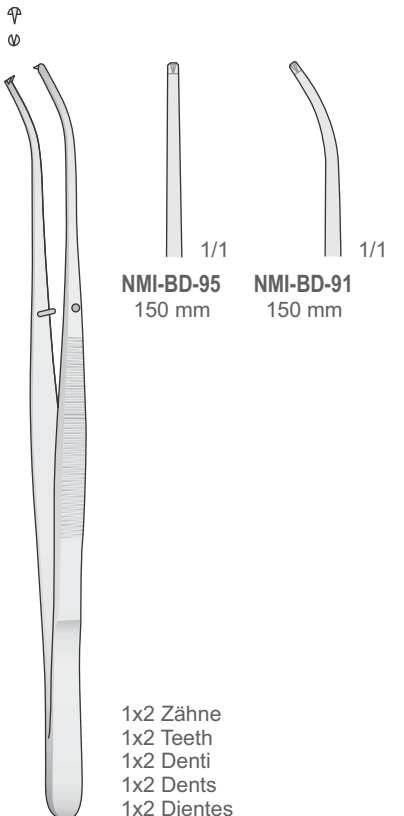
**NMI-BD-42/NMI-BD-43** 10 mm  
1



SEMKEN  
**NMI-BD-44/NMI-BD-45**  
130 mm



SEMKEN  
**NMI-BD-46/NMI-BD-47**  
130 mm



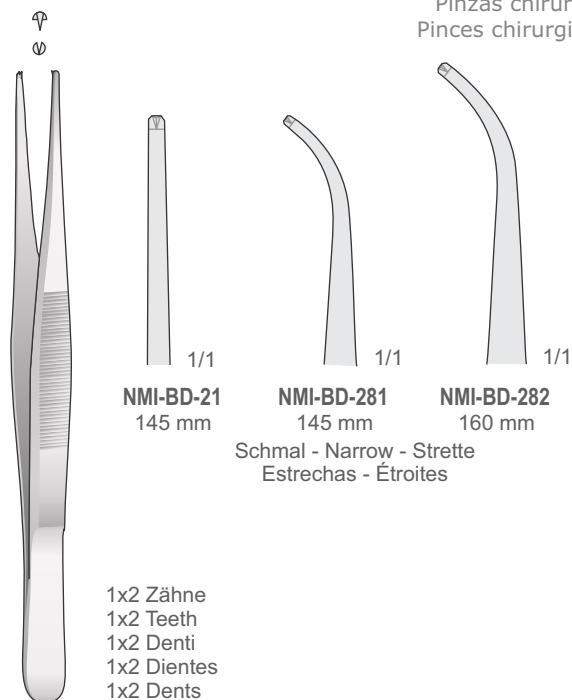
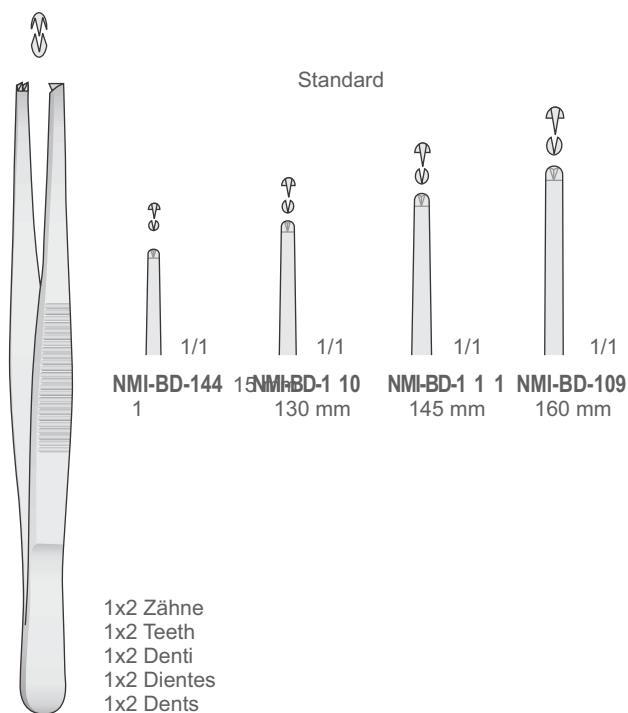
SEMKEN  
**NMI-BD-91/NMI-BD-95**  
150 mm

1x2 Zähne  
1x2 Teeth  
1x2 Denti  
1x2 Dents  
1x2 Dientes

1x2 Zähne  
1x2 Teeth  
1x2 Denti  
1x2 Dents  
1x2 Dientes



Chirurgische Pinzetten  
Tissue Forceps  
Pinzette chirurgiche  
Pinzas chirùrgicas  
Pinces chirurgicales



NMI-BD-109/NMI-BD-144

NMI-BD-21/NMI-BD-282

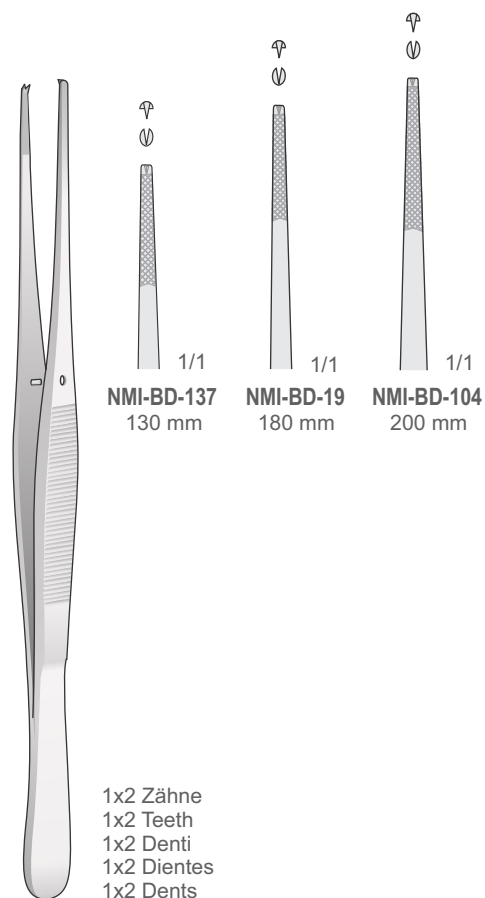
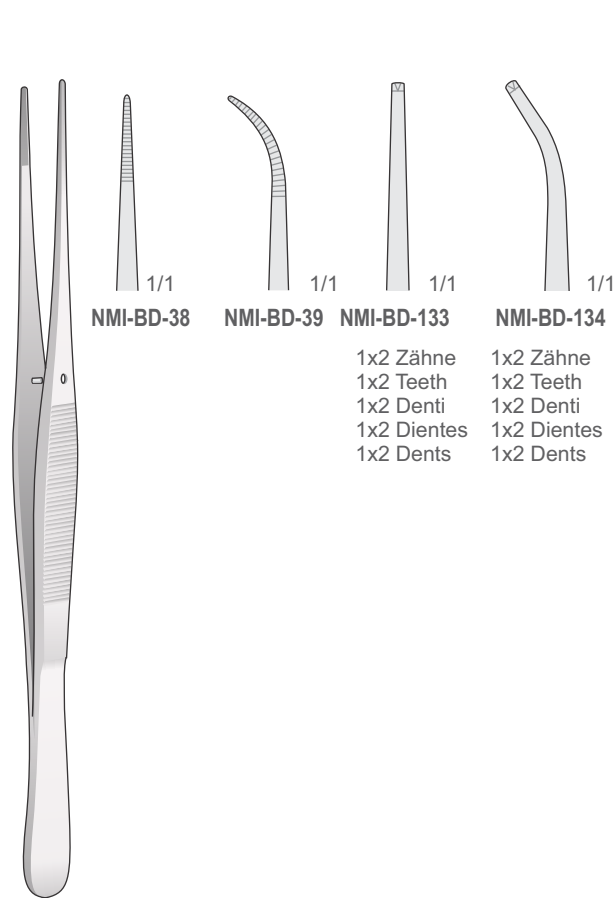
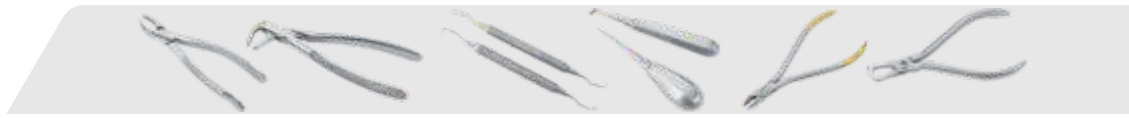
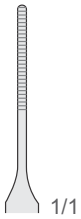


Fig.17  
NMI-BD-38/NMI-BD-134  
200 mm

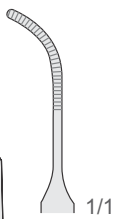
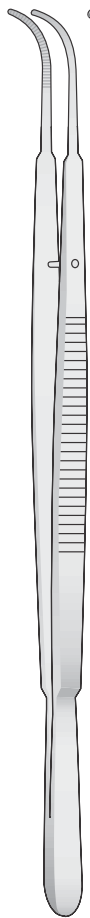
NMI-BD-19/NMI-BD-137



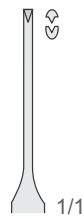
Chirurgische Pinzetten  
Tissue Forceps  
Pinzette chirurgiche  
Pinzas quirùrgicas  
Pincas quirurgicales



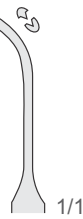
GERALD  
NMI-MF-101  
180 mm



GERALD  
NMI-MF-102  
180 mm



GERALD  
NMI-MF-103  
180 mm



GERALD  
NMI-MF-104  
180 mm

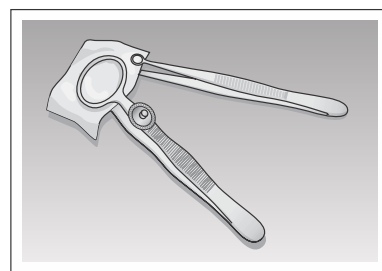
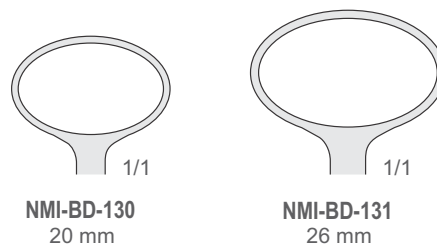
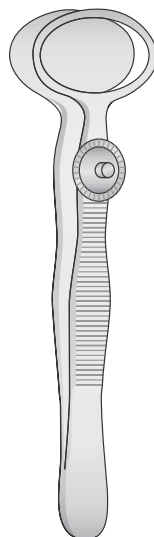
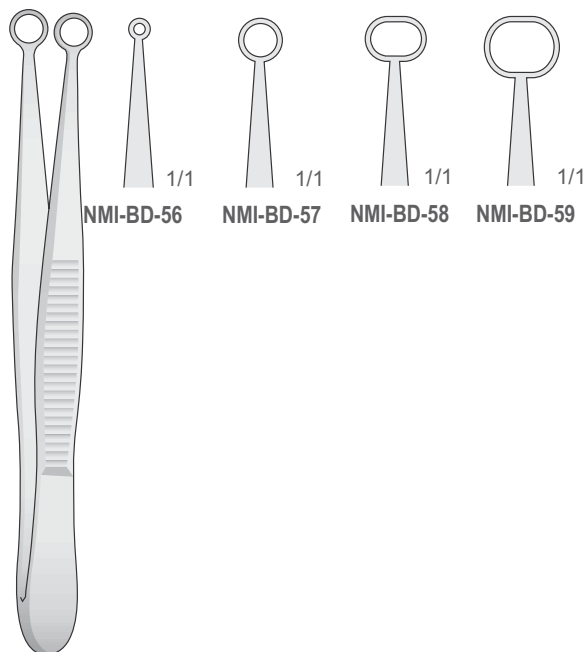


GERALD-BROWN  
NMI-MF-105  
180 mm



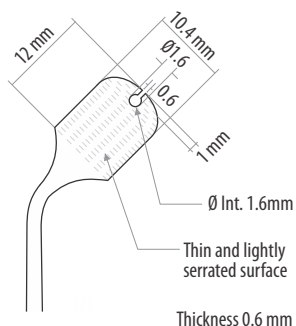
Chirurgische Pinzetten  
Tissue Forceps  
Pinzette chirurgiche  
Pinzas quirùrgicas  
Pinces chirurgicales

Membrane Forceps  
with delicate Ring tip

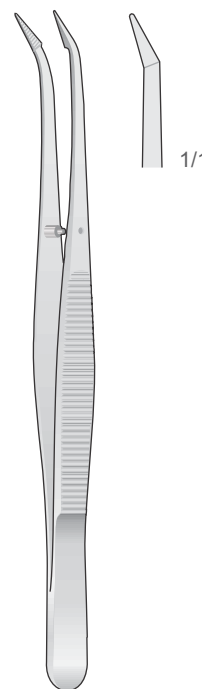
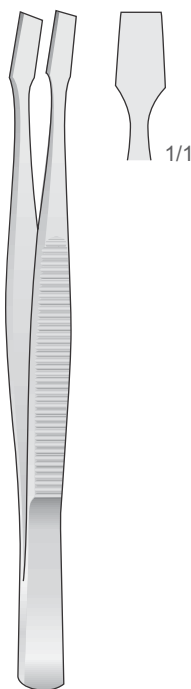
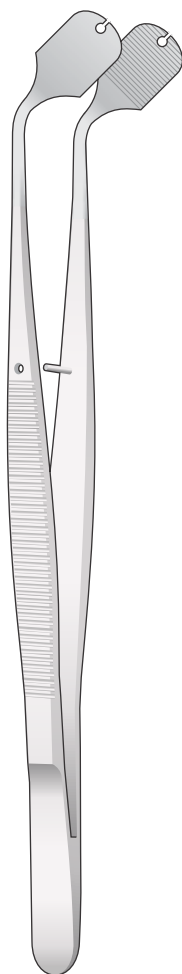


**NMI-BD-56/NMI-BD-59**  
100 mm

**DESMARRES**  
**NMI-BD-130/NMI-BD-131**  
90 mm



Pinzetten zum Halten Membranen  
Membrane Holding forceps  
Pinza per fissaggio membrane  
Pinza para sostener membranas  
Pince pour le maintien membranes



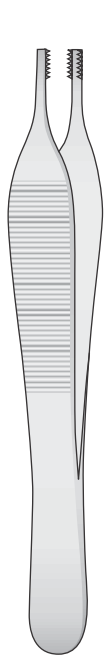
**NMI-TASO-9**  
150 mm

**KÜHNE**  
**NMI-ES-44**  
105 mm

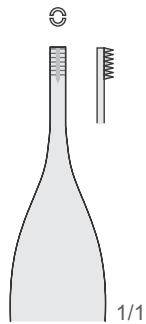
**BARRAQUER**  
**NMI-ES-65**  
105 mm



Chirurgische Pinzetten  
Tissue Forceps  
Pinzette chirurgische  
Pinzas quirúrgicas  
Pincas quirúrgicas

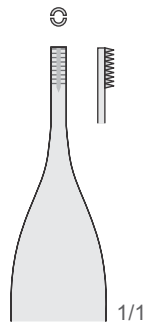


ADSON-BROWN  
NMI-BD-92/NMI-BD-141  
120 mm



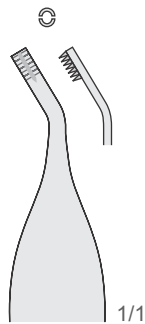
**NMI-BD-92**  
120 mm

6x6 Zähne  
6x6 Teeth  
6x6 Denti  
6x6 Dientes  
6x6 Dents



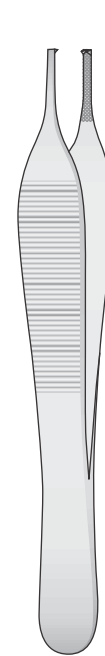
**NMI-BD-141**  
120 mm

9x9 Zähne  
9x9 Teeth  
9x9 Denti  
9x9 Dientes  
9x9 Dents

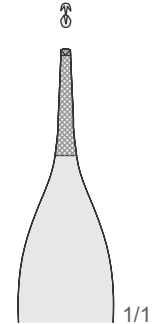


**NMI-BD-93**  
120 mm

6x6 Zähne  
6x6 Teeth  
6x6 Denti  
6x6 Dientes  
6x6 Dents



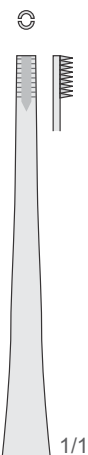
ADSON  
NMI-BD-90  
120 mm



**NMI-BD-90**  
120 mm



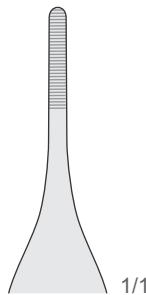
BROWN  
NMI-BD-94  
150 mm



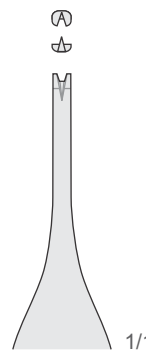
8x8 Zähne  
8x8 Teeth  
8x8 Denti  
8x8 Dientes  
8x8 Dents



ADSON  
NMI-BD-380  
150 mm



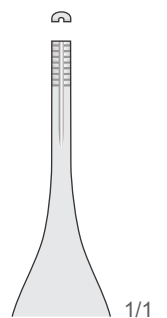
ADSON  
NMI-BD-381  
150 mm



1x2 Zähne  
1x2 Teeth  
1x2 Denti  
1x2 Dientes  
1x2 Dents



ADSON-BROWN  
NMI-BD-382  
150 mm

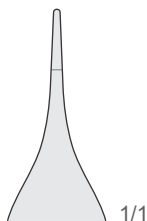


9x9 Zähne  
9x9 Teeth  
9x9 Denti  
9x9 Dientes  
9x9 Dents



Chirurgische Pinzetten  
Tissue Forceps  
Pinzette chirurgiche  
Pinzas chirùrgicas  
Pincas chirurgicales

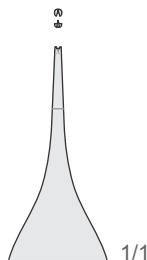
1,0 mm



Mit Fadenplatte  
With tying platform  
Con piano prendifilo  
Con plataforma  
Avec plateaux pour monofil

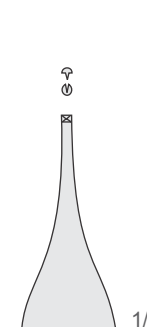
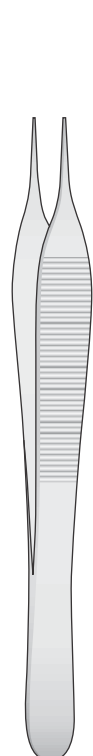
ADSON  
NMI-BD-370  
120 mm

1,0 mm

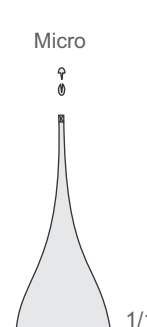


Mit Fadenplatte  
With tying platform  
Con piano prendifilo  
Con plataforma  
Avec plateaux pour monofil  
1x2 Zähne  
1x2 Teeth  
1x2 Denti  
1x2 Dientes  
1x2 Dents

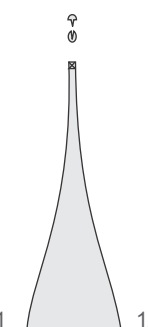
ADSON  
NMI-BD-371  
120 mm



NMI-BD-30  
120 mm

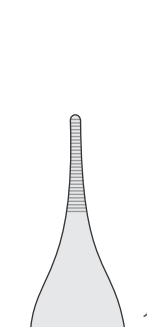


NMI-BD-73  
120 mm

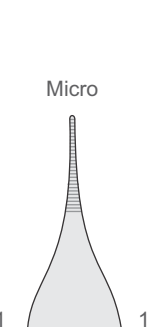


NMI-BD-70  
150 mm

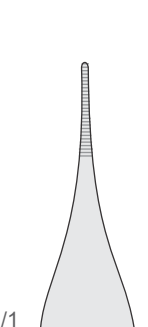
ADSON  
NMI-BD-30/NMI-BD-73



NMI-BD-31  
120 mm



NMI-BD-71  
120 mm

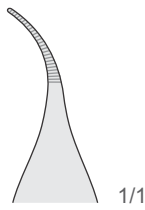


NMI-BD-72  
150 mm

ADSON  
NMI-BD-31/NMI-BD-72



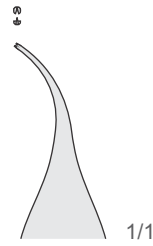
Chirurgische Pinzetten - Anatomische Pinzetten  
Tissue Forceps - Dressing forceps  
Pinzette chirurgiche - Pinzette anatomiche  
Pinzas quirúrgicas - Pinzas de diseccion  
Pincas quirurgicales - Pincas anatomiques



Extra fein  
Extra fine  
Extra fine  
Extra finas  
Extra fins

Gebogen  
Curved  
Curva  
Curvas  
Courbé

**MICRO-ADSON**  
**NMI-BD-372**  
120 mm

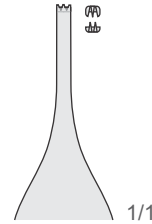


Extra fein  
Extra fine  
Extra fine  
Extra finas  
Extra fins

Gebogen  
Curved  
Curva  
Curvas  
Courbé

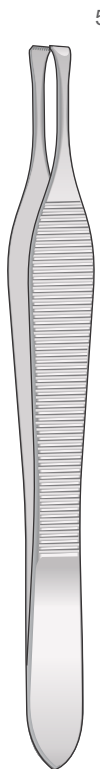
1x2 Zähne  
1x2 Teeth  
1x2 Denti  
1x2 Dientes  
1x2 Dents

**MICRO-ADSON**  
**NMI-BD-373**  
120 mm



2x3 Zähne  
2x3 Teeth  
2x3 Denti  
2x3 Dientes  
2x3 Dents

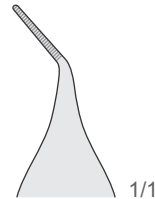
**ADSON**  
**NMI-BD-377**  
120 mm



**BEASLEY-BABCOCK**  
**NMI-BD-51**  
120 mm



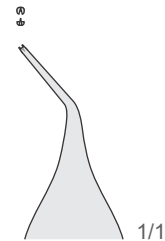
**GRAEFE**  
**NMI-BD-135**  
1



Gerieft  
Serrated  
Zigrinata  
Estrada  
Striée

Abgewinkelt  
Angled  
Angolata  
Angulada  
Coudée en haut

10 mm **ADSON**  
**NMI-BD-378**  
120 mm



1x2 Zähne  
1x2 Teeth  
1x2 Denti  
1x2 Dientes  
1x2 Dents

Abgewinkelt  
Angled  
Angolata  
Angulada  
Coudée en haut

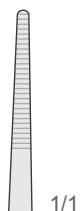
**ADSON**  
**NMI-BD-379**  
120 mm



Chirurgische Pinzetten - Anatomische Pinzetten  
Tissue Forceps - Dressing forceps  
Pinzette chirurgiche - Pinzette anatomiche  
Pinzas quirùrgicas - Pinzas de diseccion  
Pincas chirurgicales - Pincas anatomiques

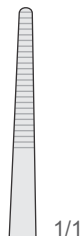


**NMI-BD-09**  
130 mm



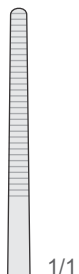
1/1

**NMI-BD-18**  
180 mm



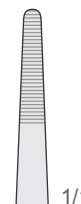
1/1

**NMI-BD-20**  
200 mm



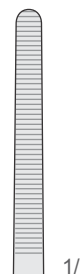
1/1

**NMI-BD-23**  
230 mm



1/1

**NMI-BD-25**  
250 mm



1/1

**NMI-BD-26**  
300 mm

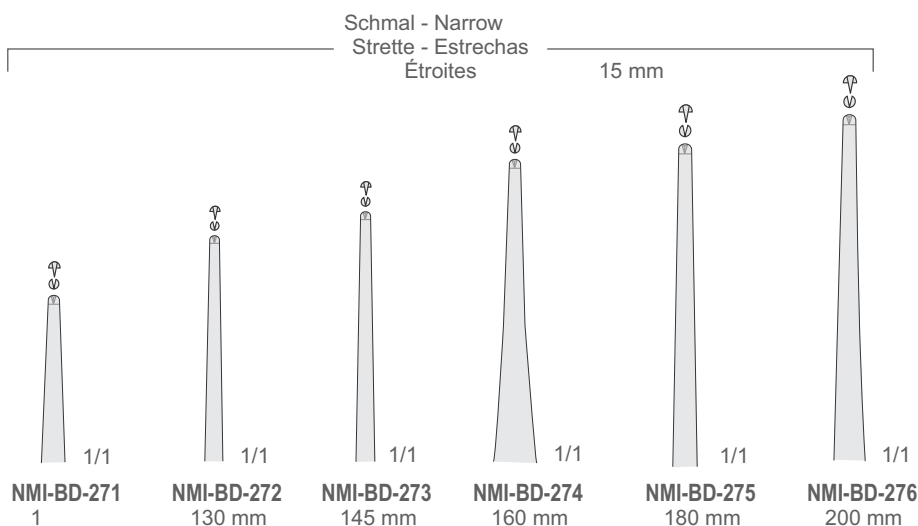


**NMI-BD-09/NMI-BD-20**

**NMI-BD-23/NMI-BD-26**



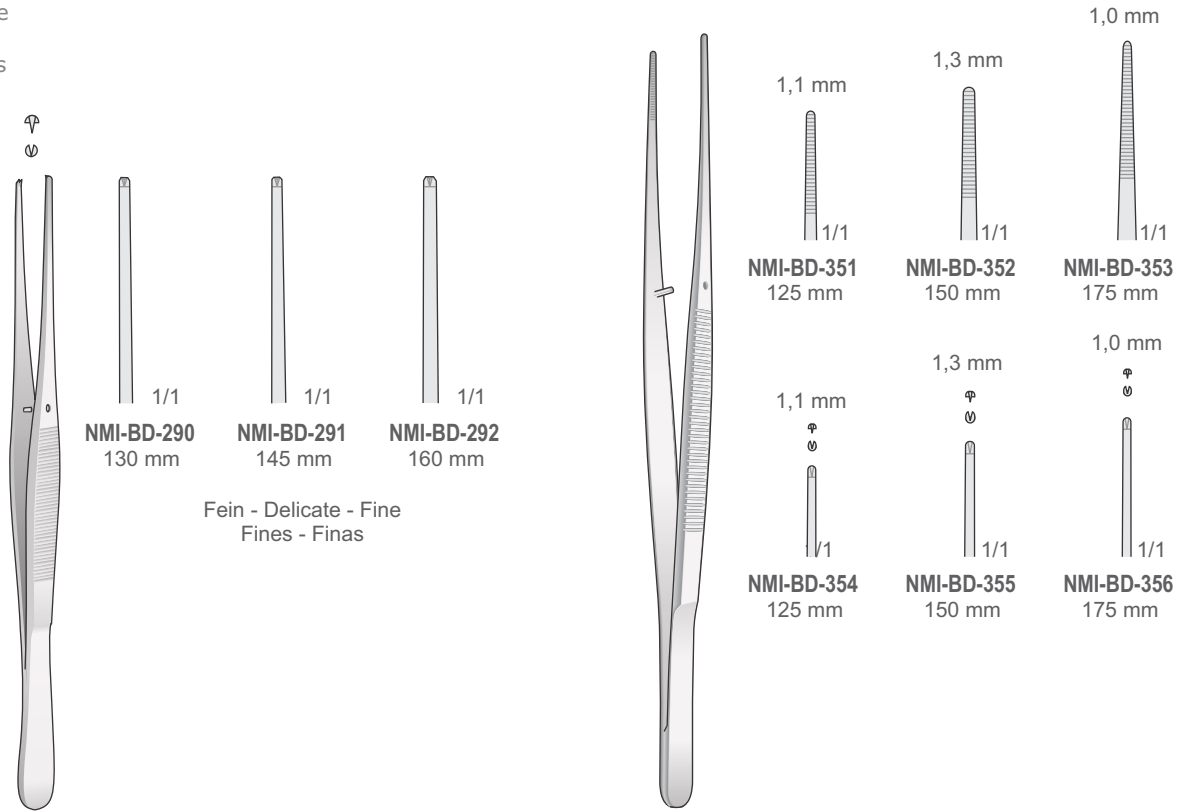
1x2 Zähne  
1x2 Teeth  
1x2 Denti  
1x2 Dientes  
1x2 Dents



**NMI-BD-271/NMI-BD-276**

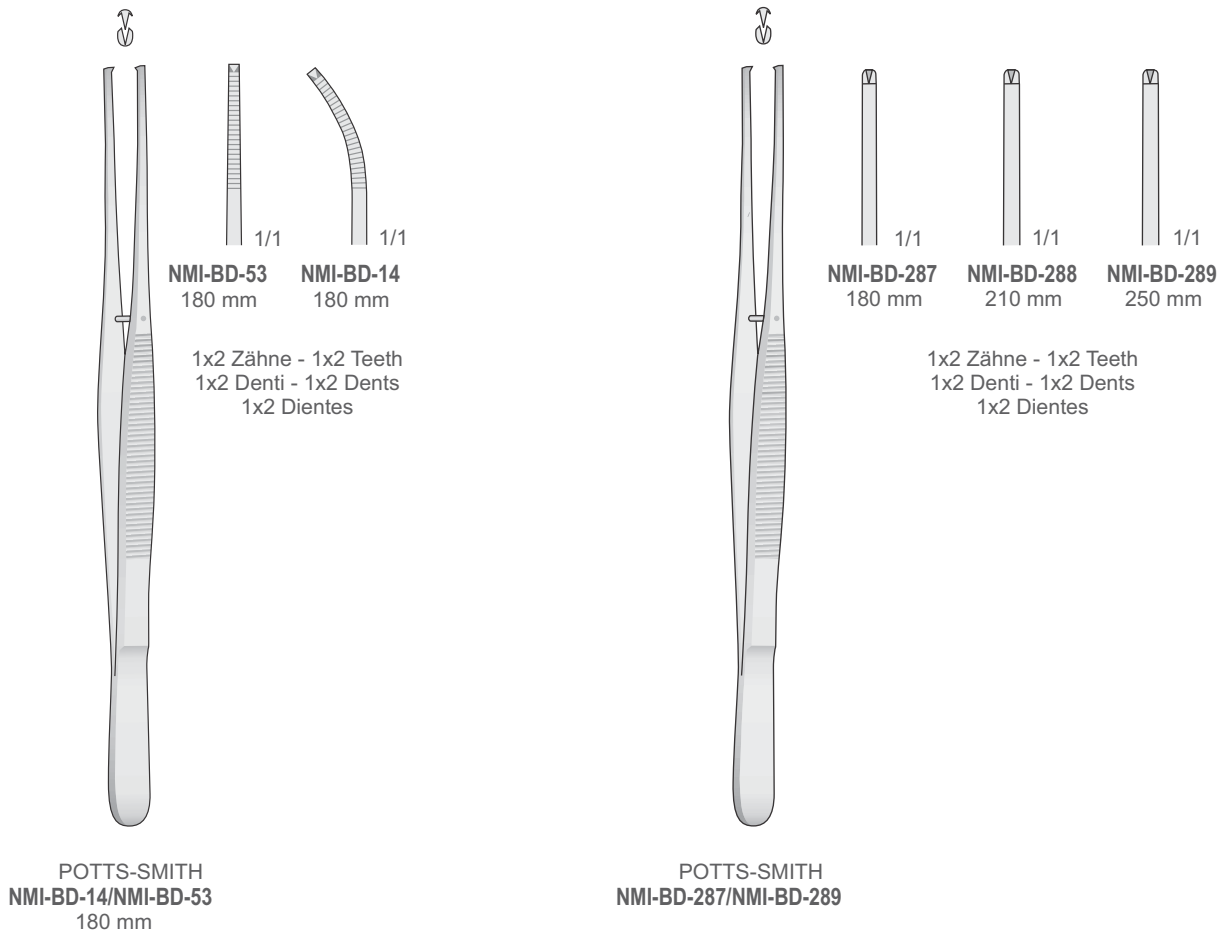


Chirurgische Pinzetten  
Tissue Forceps  
Pinzette chirurgiche  
Pinzas quirúrgicas  
Pincas quirurgicales



**NMI-BD-290/NMI-BD-292**

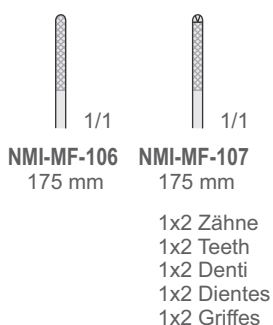
**BD-351 BD-356**





Chirurgische Pinzetten, Atraumatische Pinzetten  
Tissue Forceps, Non-traumatic Forceps  
Pinzette chirurgiche, Pinzette atraumatiche  
Pinzas quirurgicas, Pinzas atraumaticas  
Pincas chirurgicales, Pincas atraumaticas

TC



**NMI-MF-106**  
175 mm

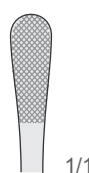
**NMI-MF-107**  
175 mm

- 1x2 Zähne
- 1x2 Teeth
- 1x2 Denti
- 1x2 Dientes
- 1x2 Griffes

GERALD  
**NMI-MF-106/NMI-MF-107**  
175 mm

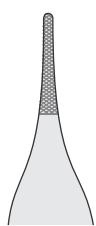
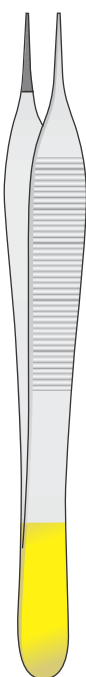
**Tungsten-Carbide Inserts**  
Mit Hartmetalleinsätzen  
Plaquettes en carbure de tungstène  
Plaquetas de carburo de tungsteno  
Inserti in carburo di tungsteno

TC

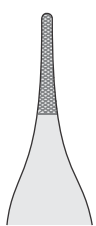


WANGENSTEEN  
**NMI-BD-232**  
150 mm

TC



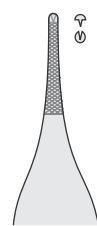
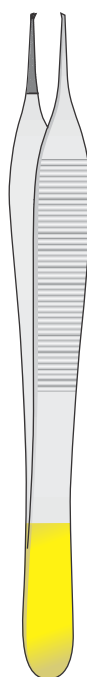
**NMI-BD-230**  
120 mm



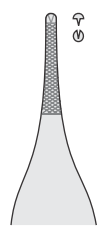
**NMI-BD-231**  
150 mm

ADSON  
**NMI-BD-230/NMI-BD-231**

TC



**NMI-BD-250**  
120 mm



**NMI-BD-251**  
150 mm

- 1x2 Zähne
- 1x2 Teeth
- 1x2 Denti
- 1x2 Dientes
- 1x2 Griffes

- 1x2 Zähne
- 1x2 Teeth
- 1x2 Denti
- 1x2 Dientes
- 1x2 Griffes

ADSON  
**NMI-BD-250/NMI-BD-251**

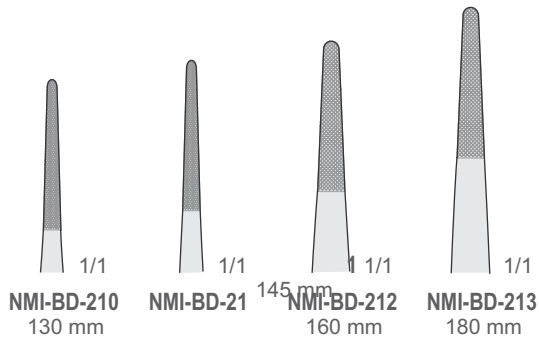


Chirurgische Pinzetten, Atraumatische Pinzetten  
Tissue Forceps, Non-traumatic Forceps  
Pinzette chirurgische, Pinzette atraumatiche  
Pinzas quirùrgicas, Pinzas atraumàticas  
Pincas quirurgicales, Pincas atraumatiques

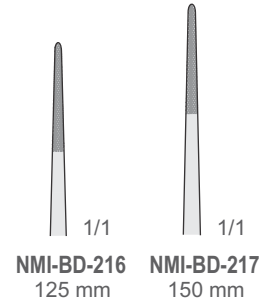


**NMI-BD-210/NMI-BD-213**

Standard



**SEMKEN  
NMI-BD-216/NMI-BD-217**

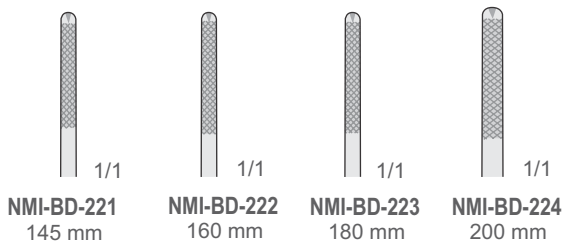


**Tungsten-Carbide Inserts**  
Mit Hartmetalleinsätzen  
Plaquettes en carbure de tungstène  
Plaquetas de carburo de tungsteno  
Inserti in carburo di tungsteno

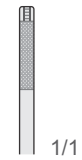
TC



**NMI-BD-221/NMI-BD-224**



TC



Mikroprofil  
Micro profile  
Profilo micro  
Perfil micro  
Profil micro

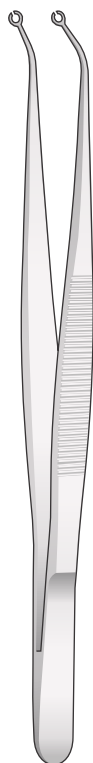
2.0 mm

**DE BAKEY  
NMI-BD-267  
160 mm**

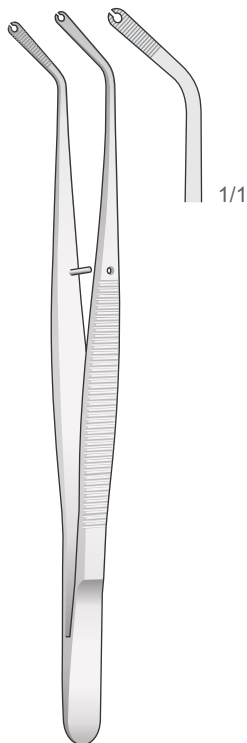


Pinzette  
Forceps  
Pinzette  
Pinzas  
Pincés

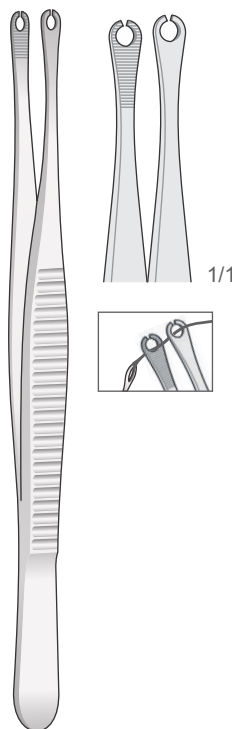
Naht- und Membranpinzette - Suture and membrane Forceps  
Pinzette per sutura e membrane - Pinzas para suturas y membranas  
Pincettes à suture et à membrane



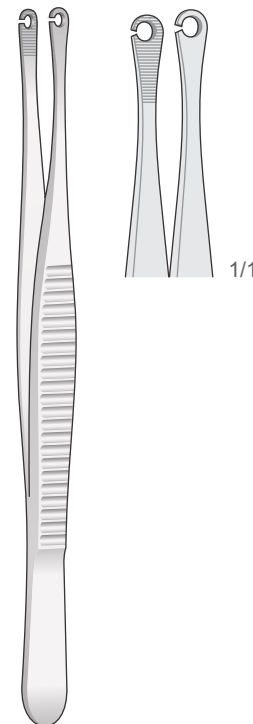
Ø Int 1.6 mm  
1/1  
**NMI-BD-158**  
Ø Int 2.2 mm  
1/1  
**NMI-BD-159**



CORN  
**NMI-DA-07**  
150 mm



**NMI-DA-06**  
150 mm



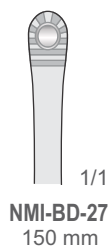
**NMI-DA-08**  
150 mm

**NMI-BD-158/NMI-BD-159**  
160 mm

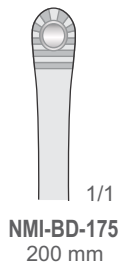
Artikulationspapier-Pinzetten - Articulating Paper Forceps  
Pinza per carta articolazione - Pinzas para papel de articular  
Pince pour papier à articuler



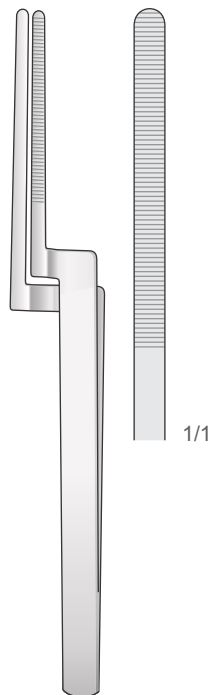
RUSSIAN  
**NMI-BD-27/NMI-BD-175**



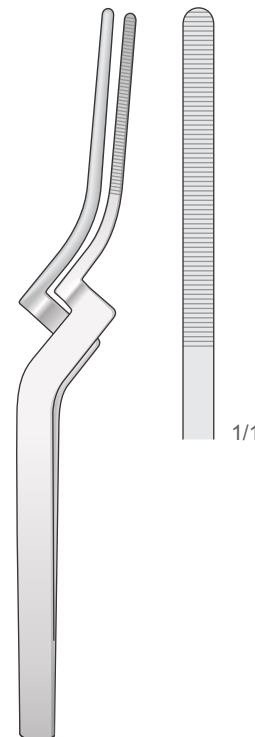
1/1  
**NMI-BD-27**  
150 mm



1/1  
**NMI-BD-175**  
200 mm



MILLER  
**NMI-DR-78**  
145 mm



MILLER  
**NMI-DR-80**  
160 mm

# DENTAL Instruments

Extracting Forceps

Root Elevators

Scalpel Blades and Handles

Surgical Scissors

Tissue and Dressing Forceps

Needle Holders

Hemostatic Forceps | Towel Clamps

Retractors | Mouth Gags

Implantology

Periosteal | Curettes | Rongeurs

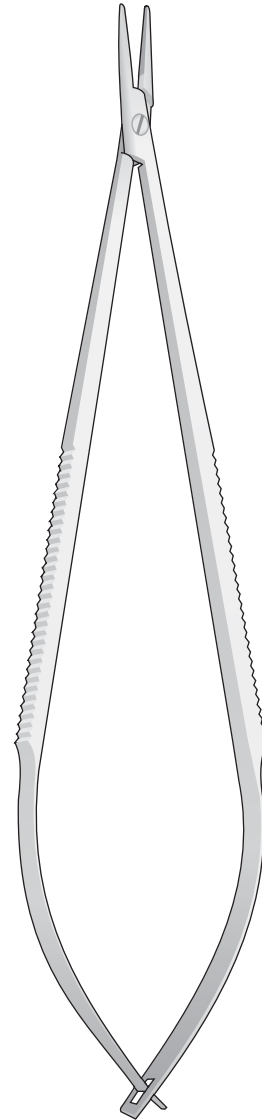
Dental Restoration | Periodontology

Suction Tube

Orthodontics

Crown Instruments | Laboratory

Instrument Maintenance | Sterilization



137-158

**Needle Holders**

Nadelhalter

Porte-aiguilles

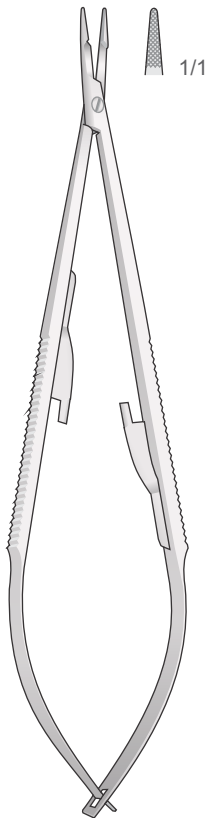
Porta-agujas

Port aghi



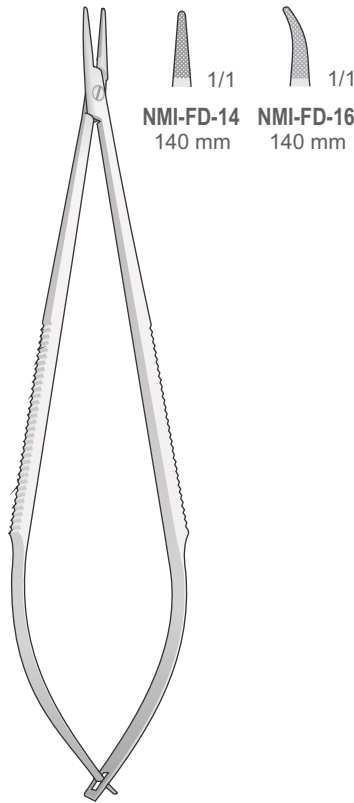
Nadelhalter  
Needle Holders  
Port'aghi  
Portaagujas  
Porte aiguilles

Mit Scheren  
With Scissor  
Con forbice  
Con tijeras  
Avec ciseaux

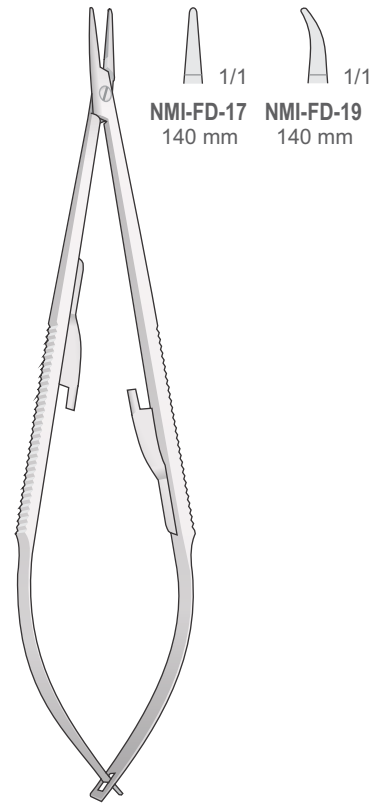


**NMI-FD-26**  
140 mm

Glattes Maul  
Smooth Jaw  
Morso liscio  
Mandibula lisa  
Mors lisse



**NMI-FD-14/NMI-FD-16**  
140 mm



**CASTROVIEJO**  
**NMI-FD-17/NMI-FD-19**  
140 mm

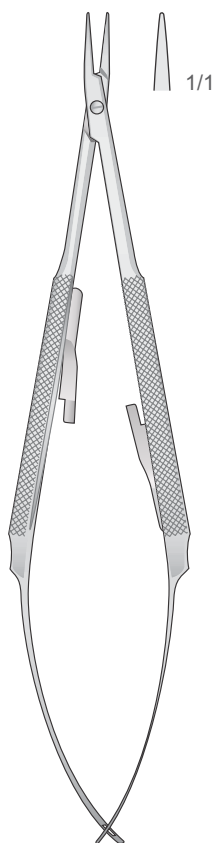


Nadelhalter  
Needle Holders  
Port'aghi  
Portaagujas  
Porte aiguilles

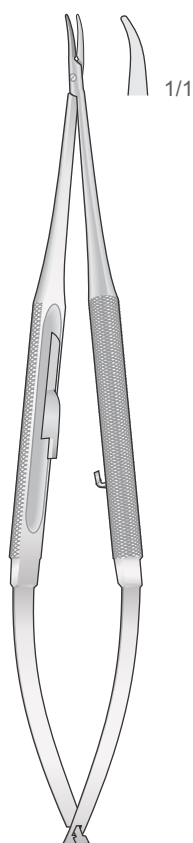
Mit Locking-System  
With Locking System (stop)  
Con sistema di bloccaggio  
Con sistema de bloqueo  
Avec système de verrouillage

Glattes Maul  
Smooth Jaw  
Morso liscio  
Mandíbula lisa  
Mors lisse

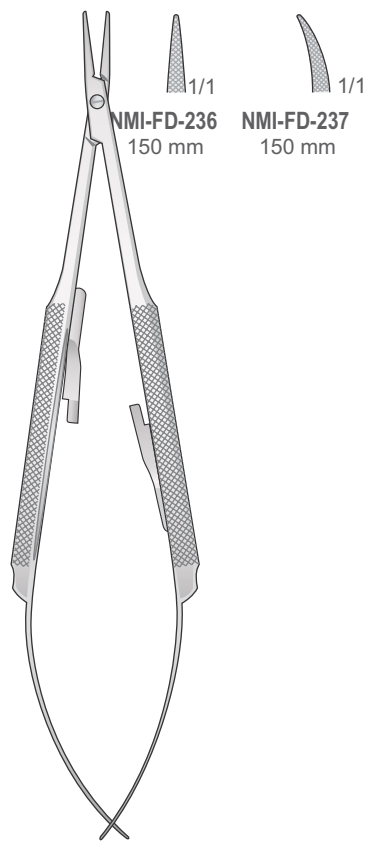
Feingerieftes Maul  
Fine serrated jaws  
Morso zigrinato fine  
Mandíbula estriada fina  
Mors strié fin



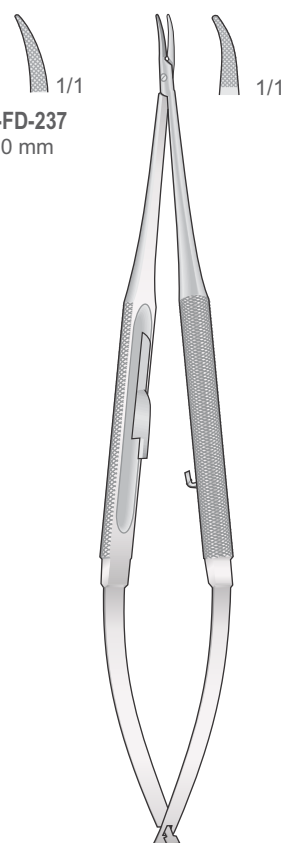
**BARRAQUER**  
**NMI-FD-216**  
150 mm



**BARRAQUER**  
**NMI-FD-217**  
150 mm



**BARRAQUER**  
**NMI-FD-236/NMI-FD-237**  
150 mm

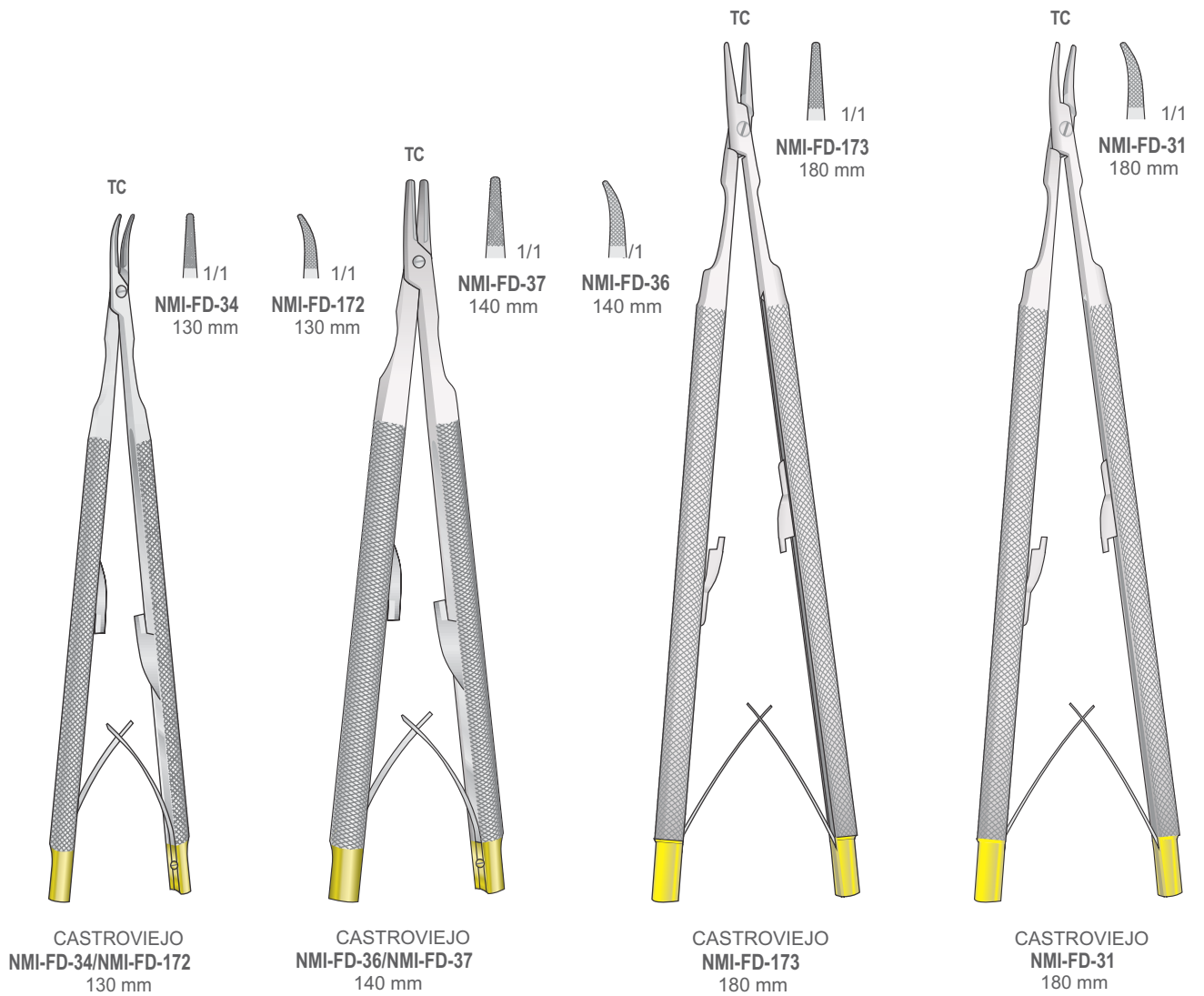


**BARRAQUER**  
**NMI-FD-24**  
150 mm



Nadelhalter  
Needle Holders  
Port'aghi  
Portaagujas  
Porte aiguilles

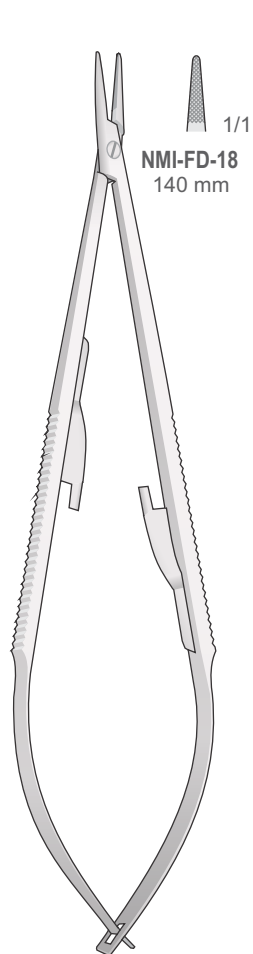
**Tungsten-Carbide Inserts**  
Mit Hartmetalleinsätzen  
Plaquettes en carbure de tungstène  
Plaquetas de carburo de tungsteno  
Inserti in carburo di tungsteno





Nadelhalter  
Needle Holders  
Port'aghi  
Portaagujas  
Porte aiguilles

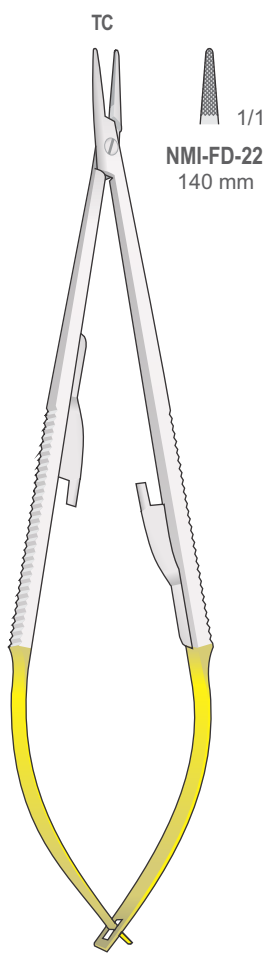
**Tungsten-Carbide Inserts**  
Mit Hartmetalleinsätzen  
Plaquettes en carbure de tungstène  
Plaquetas de carburo de tungsteno  
Inserti in carburo di tungsteno



**NMI-FD-18**  
140 mm



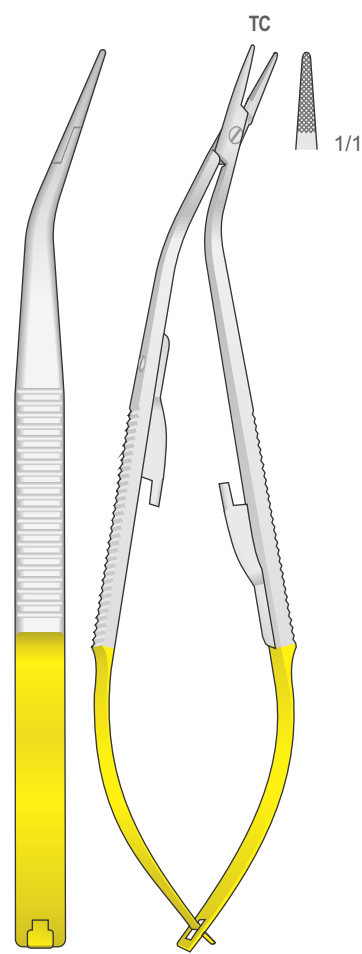
**NMI-FD-20**  
140 mm



**NMI-FD-22**  
140 mm



**NMI-FD-28**  
140 mm



**CASTROVIEJO Mod.**  
**NMI-FD-22A**  
140 mm

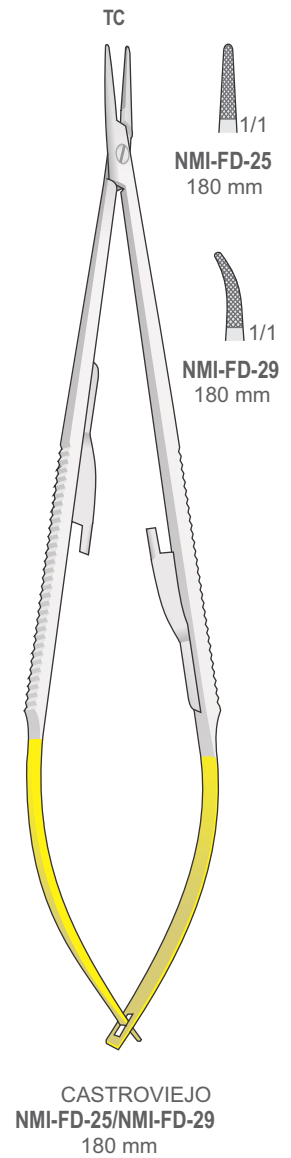
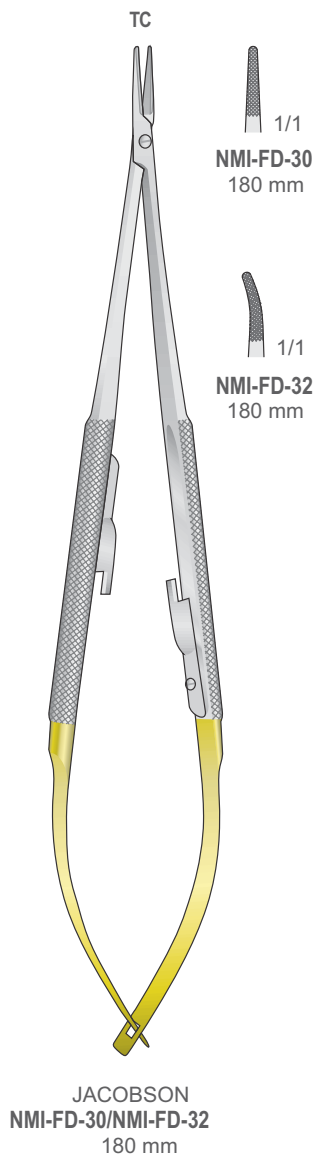
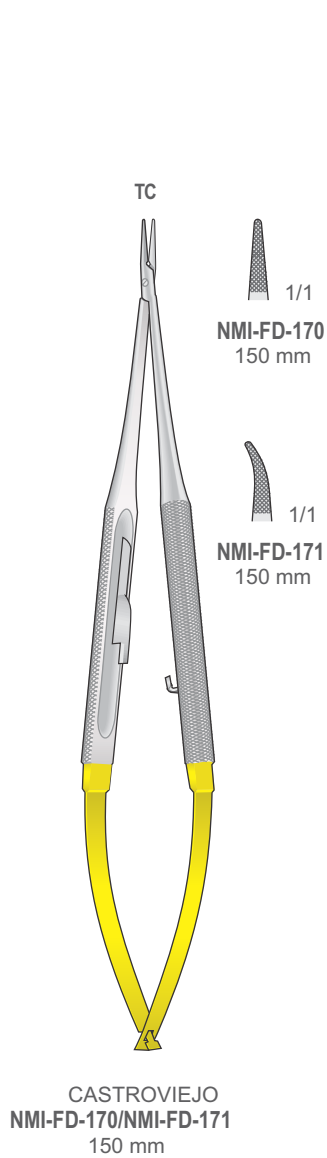
**CASTROVIEJO**  
**NMI-FD-18/NMI-FD-20**  
140 mm

**CASTROVIEJO**  
**NMI-FD-22/NMI-FD-28**  
140 mm



Nadelhalter  
Needle Holders  
Port'aghi  
Portaagujas  
Porte aiguilles

**Tungsten-Carbide Inserts**  
Mit Hartmetalleinsätzen  
Plaquettes en carbure de tungstène  
Plaquetas de carburo de tungsteno  
Inserti in carburo di tungsteno





Nadelhalter  
Needle Holders  
Port'aghi  
Porte agujas  
Porte aiguilles

**Tungsten-Carbide Inserts**  
Mit Hartmetalleinsätzen  
Plaquettes en carbure de tungstène  
Plaquetas de carburo de tungsteno  
Inserti in carburo di tungsteno

TC

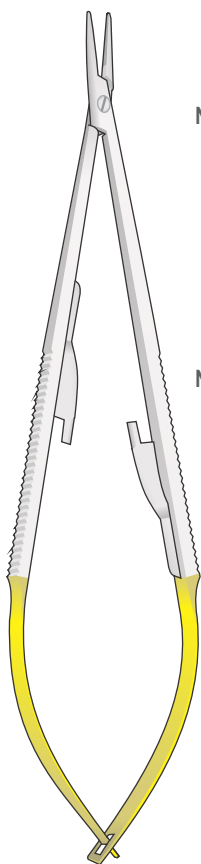
Glattes Maul  
Smooth jaws  
Con morso liscio  
Mandibula lisa  
A' mors lisse



1/1  
**NMI-FD-21**  
140 mm



1/1  
**NMI-FD-23**  
140 mm



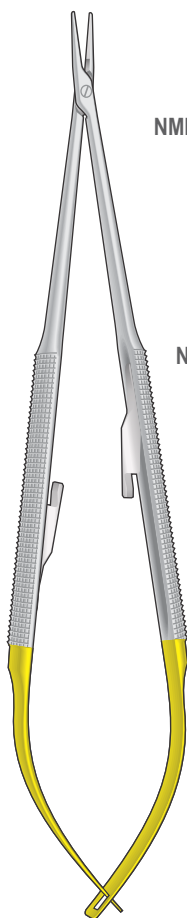
CASTROVIEJO  
NMI-FD-21/NMI-FD-23  
140 mm



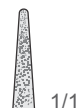
1/1  
**NMI-FD-599**



1/1  
**NMI-FD-600**



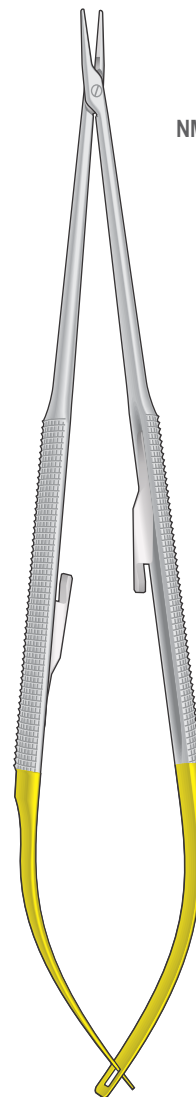
NMI-FD-599/NMI-FD-600  
150 mm



1/1  
**NMI-FD-601**



1/1  
**NMI-FD-602**



NMI-FD-601/NMI-FD-602  
180 mm

**Diamond Tip**  
Diamantiert  
Punta diamantata  
Punta de diamante  
Pointe de diamant



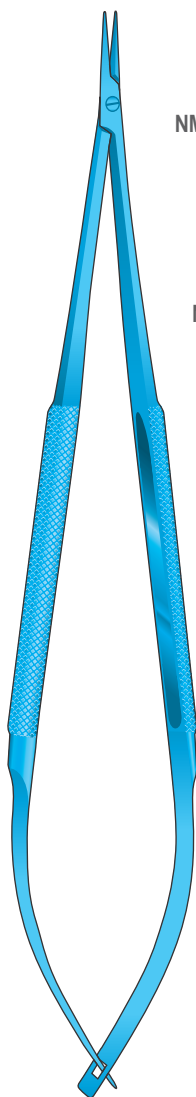
Mikro Nadelhalter - Mikro Scheren  
Micro Needle Holders - Micro Scissors  
Micro Port'aghi - Micro Forbici  
Micro Portaaguja - Micro Tijeras  
Micro Porte aiguilles - Micro Ciseaux

**Titanium**  
Titan  
Titane  
Titanio  
Titanio

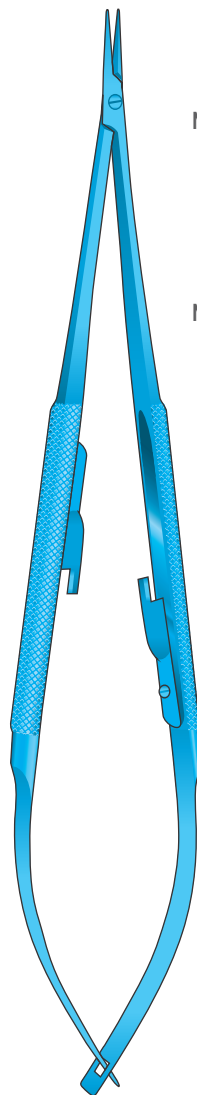
Rund-Griffe Ø 8 mm  
Round handle Ø 8 mm  
Manico rotondo Ø 8 mm  
Mango redondo Ø 8 mm  
Manche rond Ø 8 mm

Mikro Nadelhalter  
Micro Needle Holders  
Micro port'aghi  
Micro portaaguja  
Micro porte aiguilles

Mikro Scheren  
Micro Scissors  
Micro forbici  
Micro tijeras  
Micro ciseaux

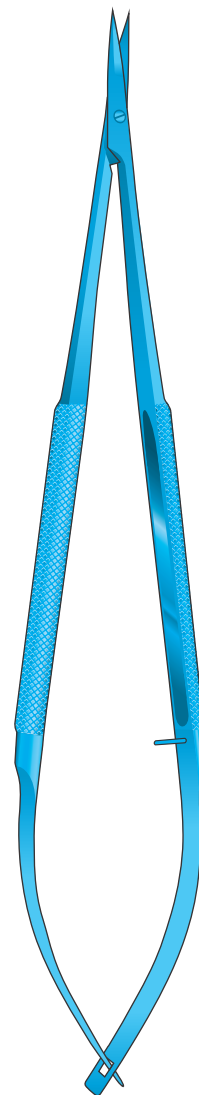


NMI-FD-562T/NMI-FD-563T  
180 mm



Mit Sperre  
With Lock  
Con arresto  
Con cierre  
Avec Arrêt

NMI-FD-574T/NMI-FD-575T  
180 mm

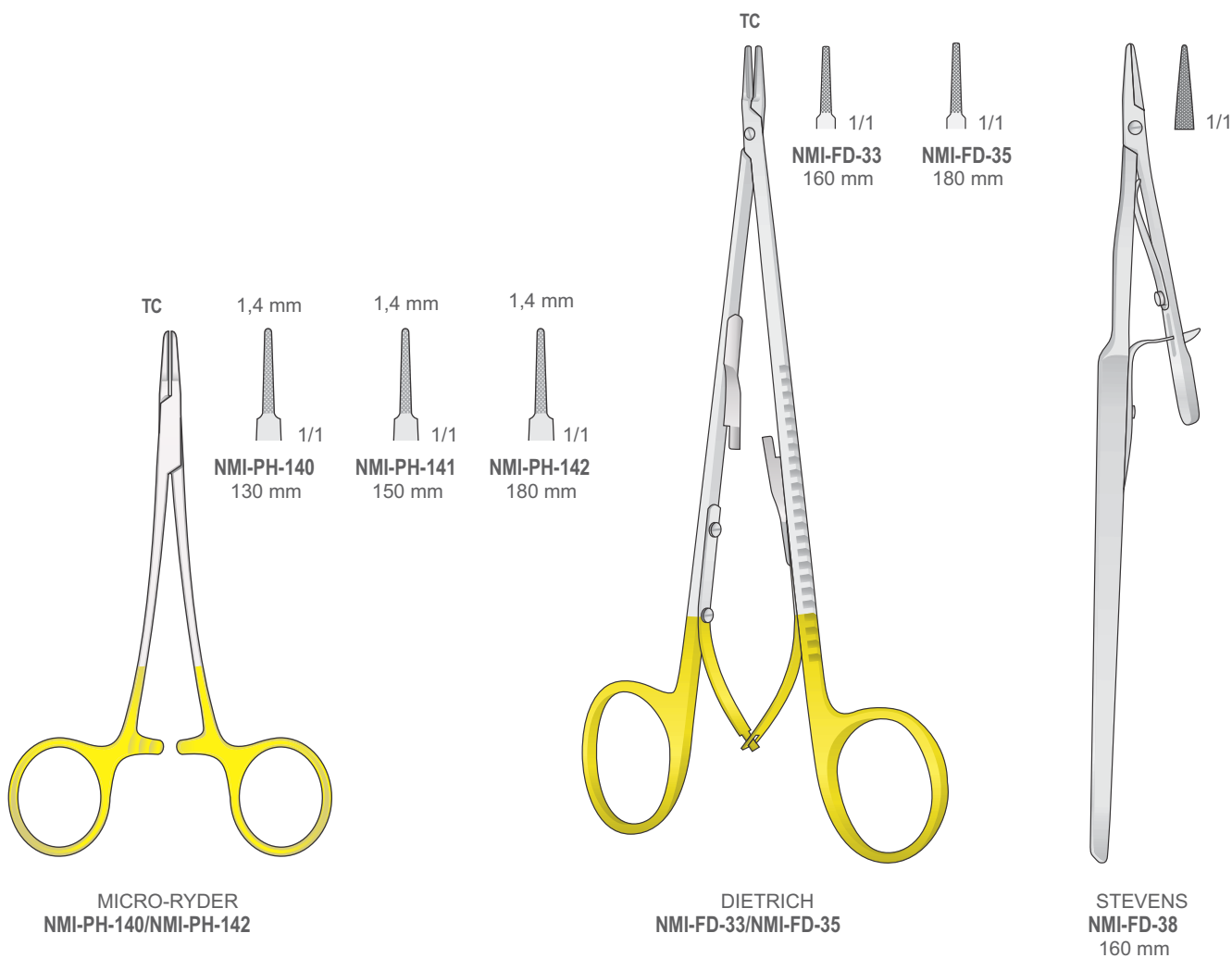


NMI-FD-587T/NMI-FD-588T  
180 mm



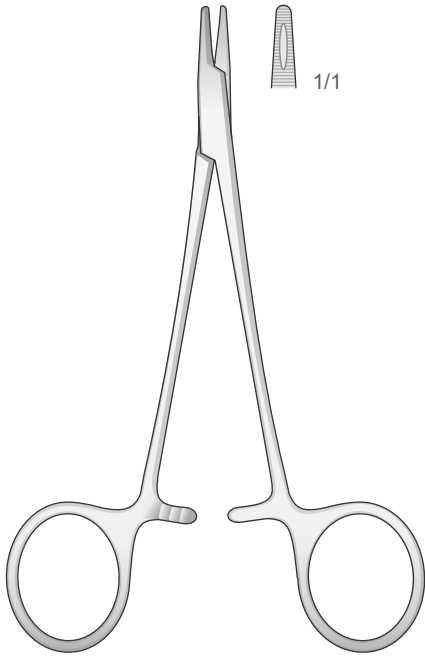
Nadelhalter  
Needle Holders  
Port'aghi  
Portaagujas  
Porte aiguilles

**Tungsten-Carbide Inserts**  
Mit Hartmetalleinsätzen  
Plaquettes en carbure de tungstène  
Plaquetas de carburo de tungsteno  
Inserti in carburo di tungsteno

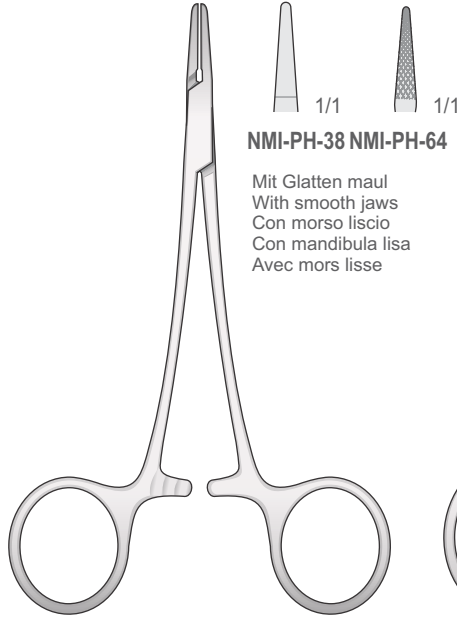




Nadelhalter  
Needle Holders  
Port'aghi  
Portaagujas  
Porte aiguilles



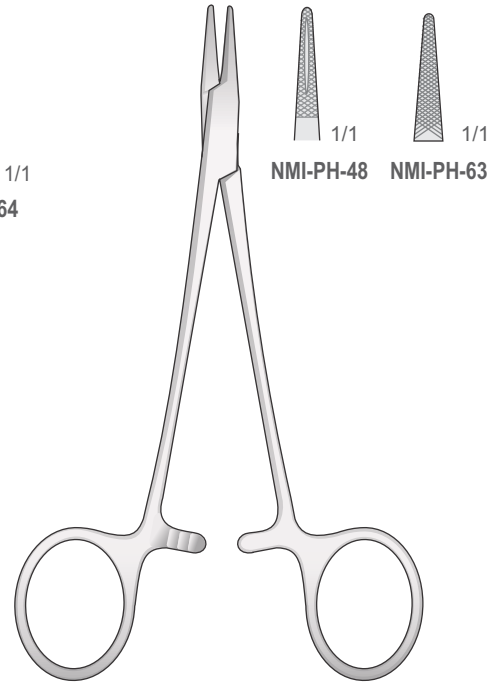
DERF  
NMI-PH-39  
125 mm



**NMI-PH-38 NMI-PH-64**

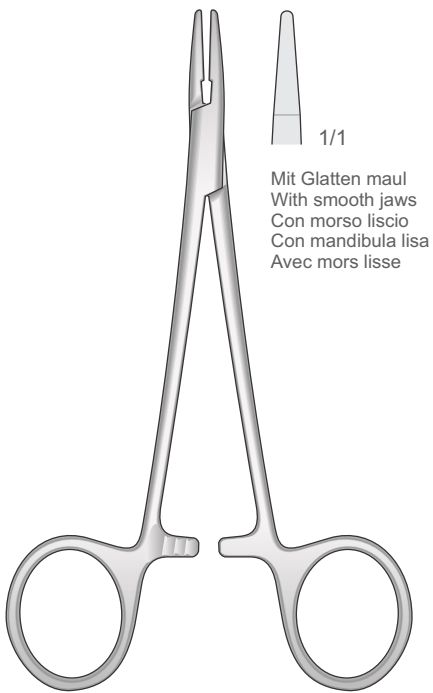
Mit Glatten maul  
With smooth jaws  
Con morso liscio  
Con mandibula lisa  
Avec mors lisse

**NMI-PH-38/NMI-PH-64**  
120 mm



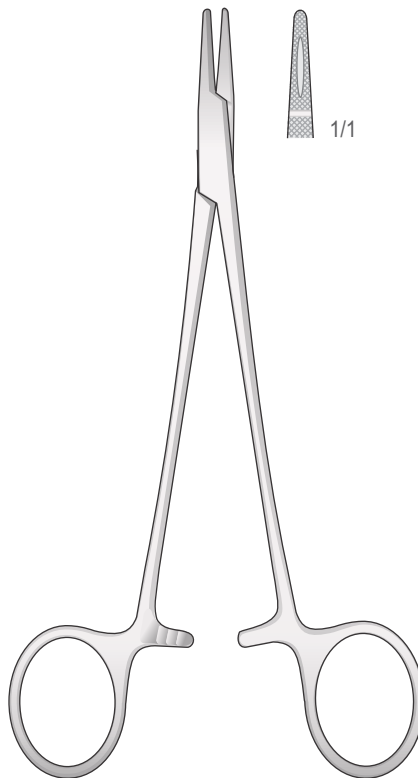
**NMI-PH-48 NMI-PH-63**

HALSEY  
NMI-PH-48/NMI-PH-63  
130 mm

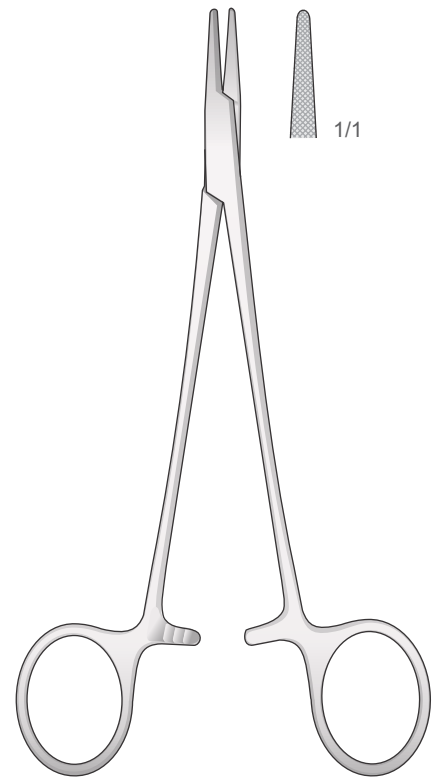


Mit Glatten maul  
With smooth jaws  
Con morso liscio  
Con mandibula lisa  
Avec mors lisse

HALSEY  
NMI-PH-37  
130 mm



CRILE-WOOD  
NMI-PH-61  
150 mm

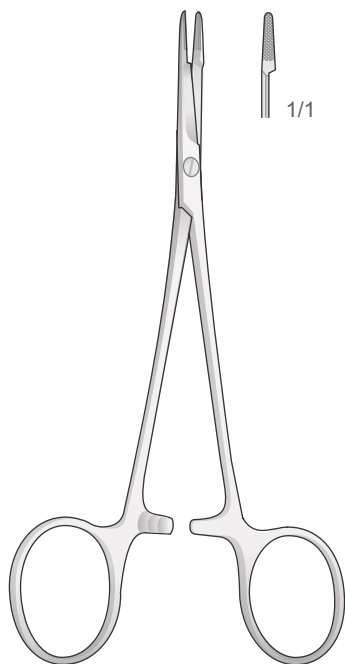


CRILE-MURRAY  
NMI-PH-62  
150 mm

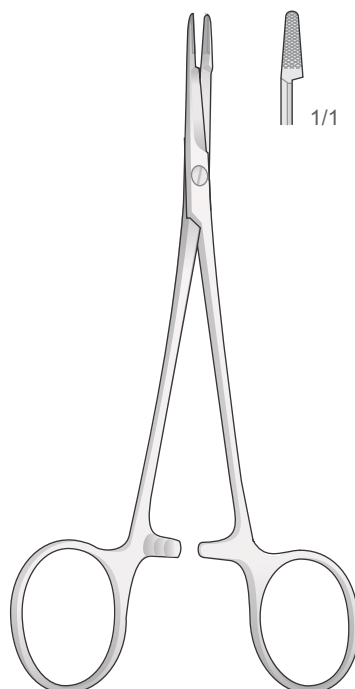


Nadelhalter mit Schere - Needle holders with scissors  
Port'aghi con forbici - Portaagujas con tijeras  
Porte aiguilles avec ciseaux

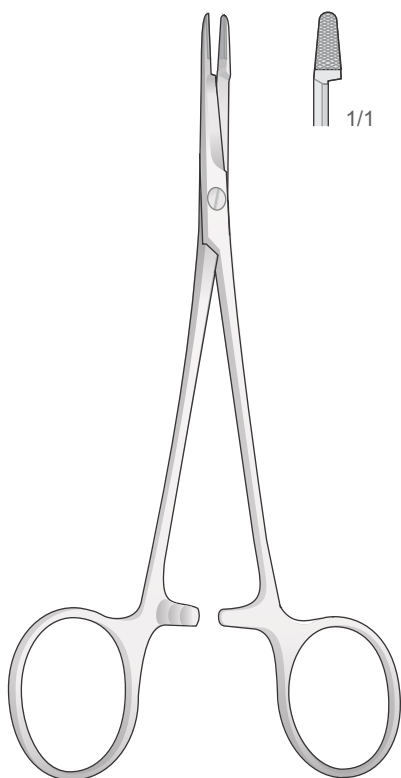
Nadelhalter  
Needle Holders  
Port'aghi  
Portaagujas  
Porte aiguilles



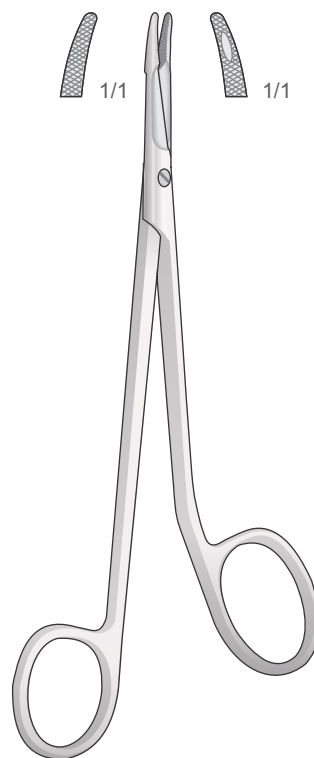
MINI-OLSEN-HEGAR  
**NMI-BM-61**  
120 mm



OLSEN-HEGAR  
**NMI-BM-62**  
140 mm



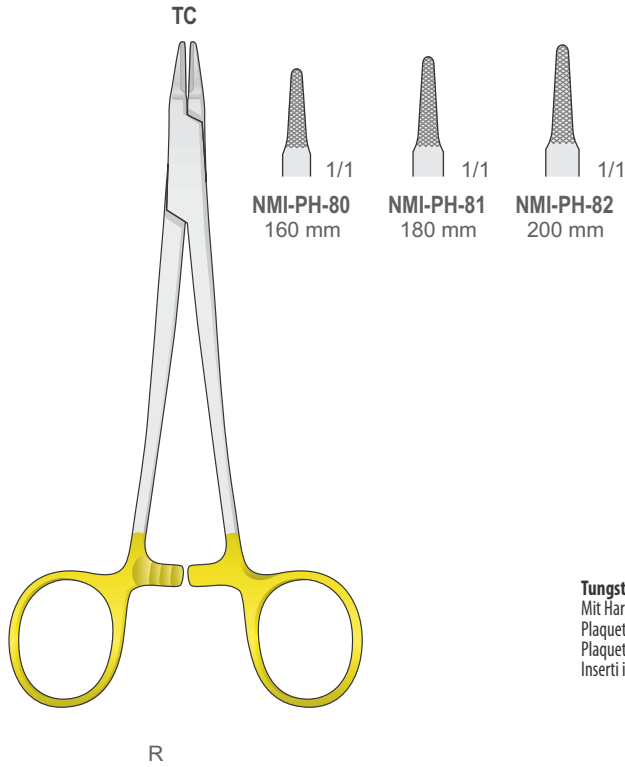
OLSEN-HEGAR  
**NMI-BM-63**  
170 mm



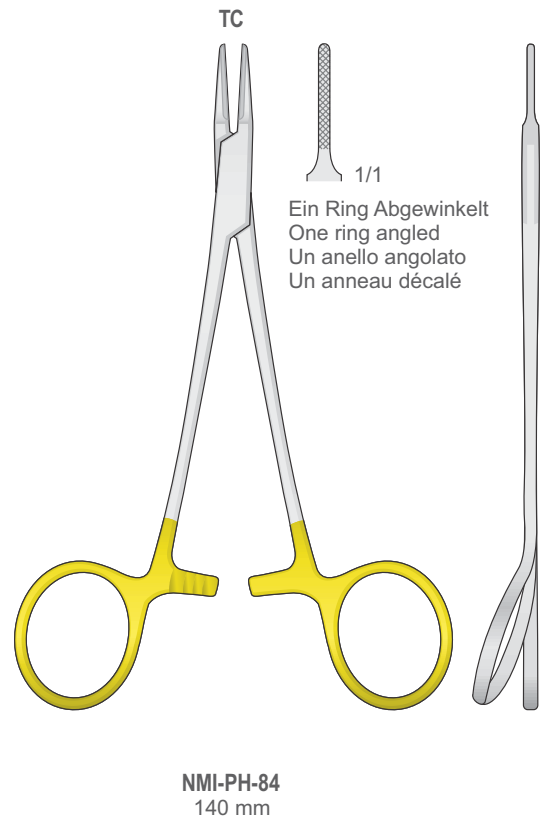
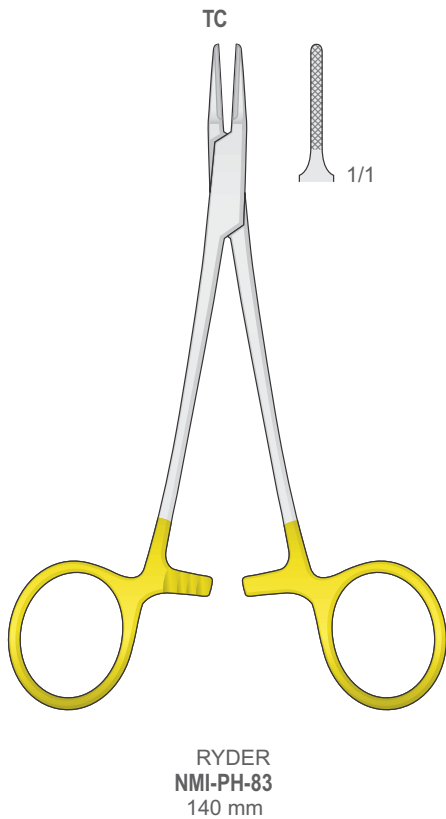
MINI-GILLIES  
**NMI-PO-59**  
145 mm



Nadelhalter  
Needle Holders  
Port'aghi  
Portaagujas  
Porte aiguilles YDER  
**NMI-PH-80/NMI-PH-82**



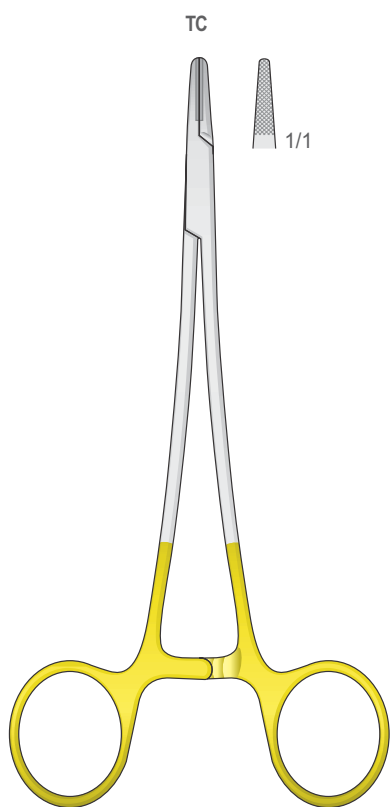
**Tungsten-Carbide Inserts**  
Mit Hartmetalleinsätzen  
Plaquettes en carbure de tungstène  
Plaquetas de carburo de tungsteno  
Inserti in carburo di tungsteno



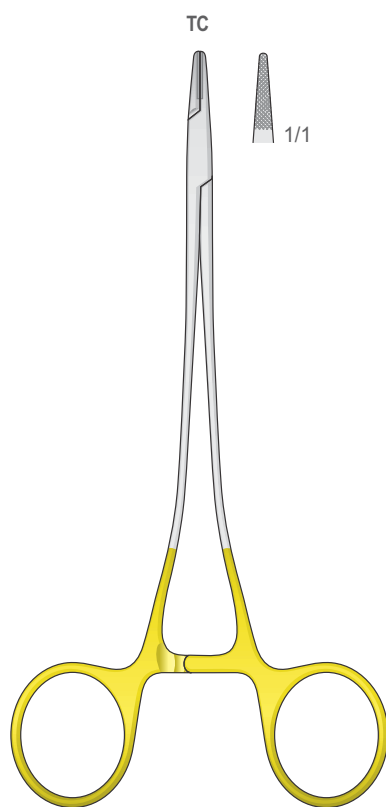


Nadelhalter  
Needle Holders  
Port'aghi  
Portaagujas  
Porte aiguilles

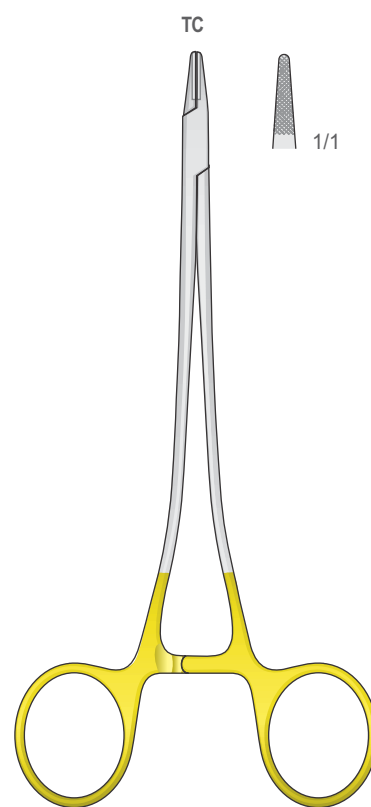
**Tungsten-Carbide Inserts**  
Mit Hartmetalleinsätzen  
Plaquettes en carbure de tungstène  
Plaquetas de carburo de tungsteno  
Inserti in carburo di tungsteno



**NMI-PH-79**  
145 mm



**FINE SWEDISH PATTERN**  
**NMI-PH-85**  
150 mm

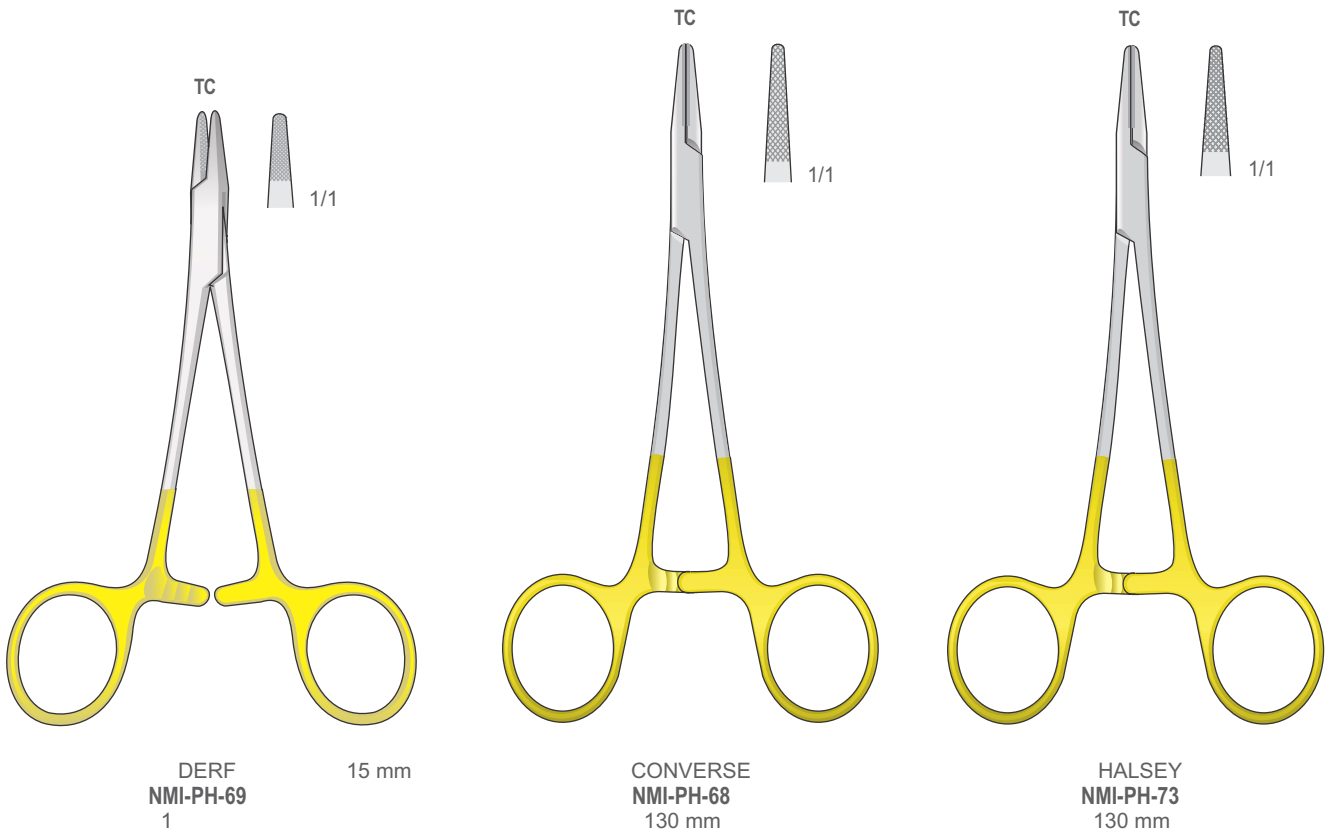
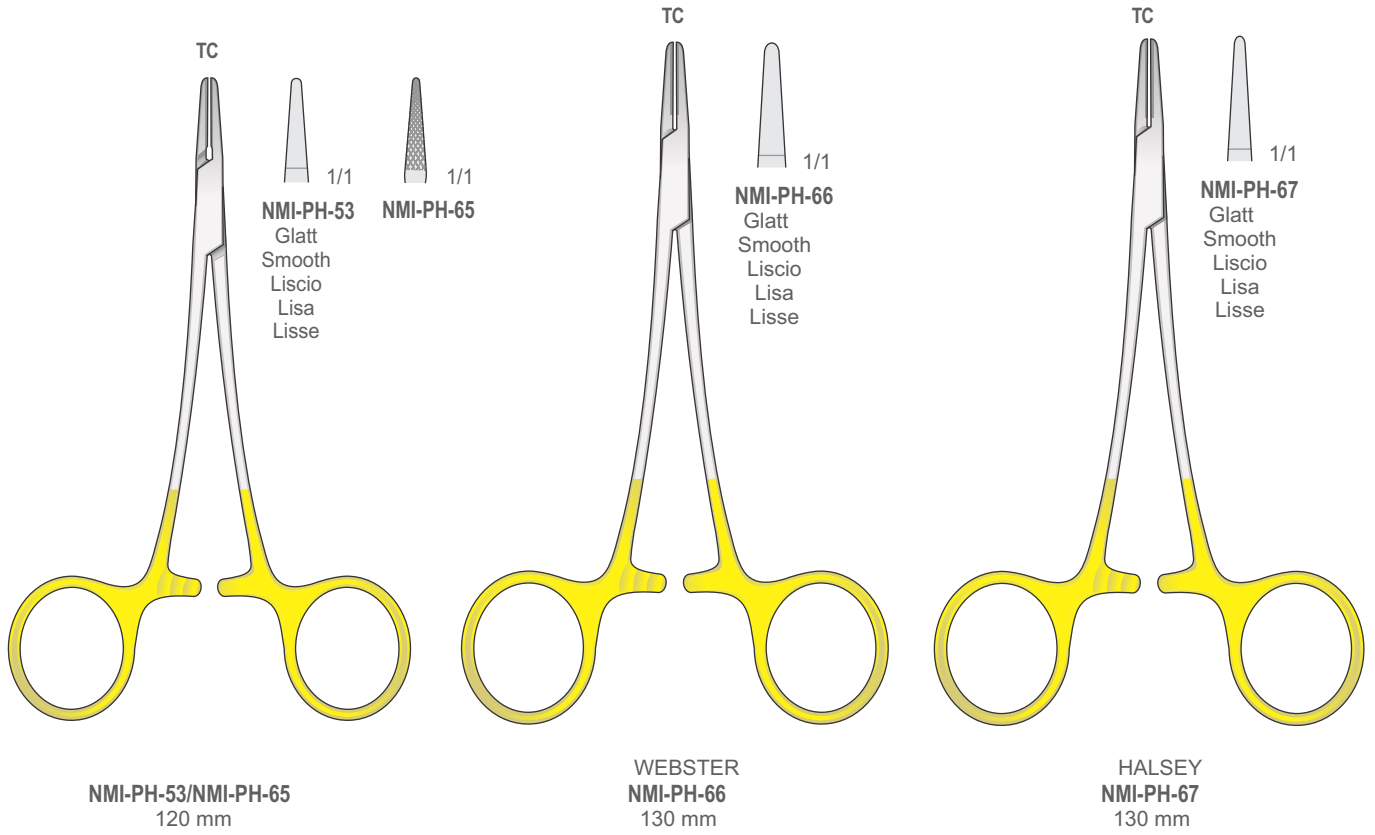


**SWEDISH MOD.**  
**NMI-PH-106**  
150 mm



Nadelhalter  
Needle Holders  
Port'aghi  
Portaagujas  
Porte aiguilles

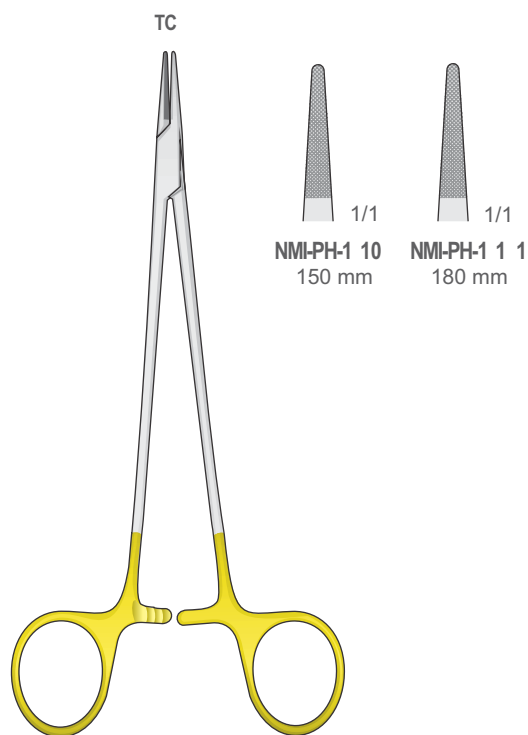
**Tungsten-Carbide Inserts**  
Mit Hartmetalleinsätzen  
Plaquettes en carbure de tungstène  
Plaquetas de carburo de tungsteno  
Inserti in carburo di tungsteno



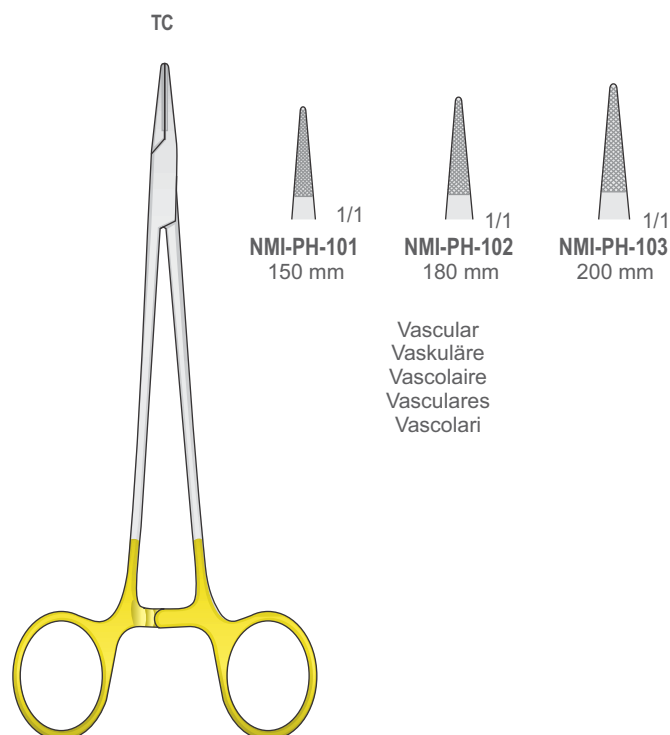


**Tungsten-Carbide Inserts**  
Mit Hartmetalleinsätzen  
Plaquettes en carbure de tungstène  
Plaquetas de carburo de tungsteno  
Inserti in carburo di tungsteno

Nadelhalter  
Needle Holders  
Port'aghi  
Portaagujas  
Porte aiguilles

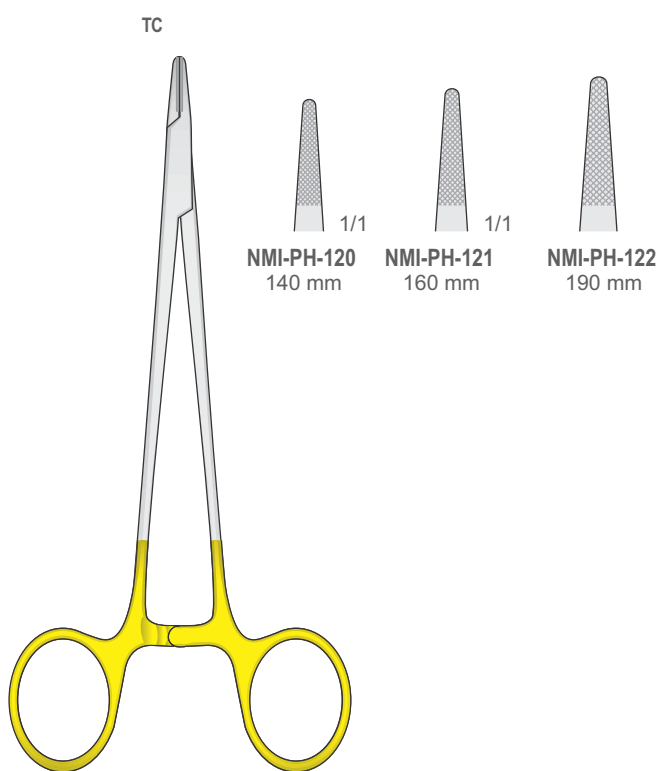


DE BAKEY  
NMI-PH-1 10/NMI-PH-11 1

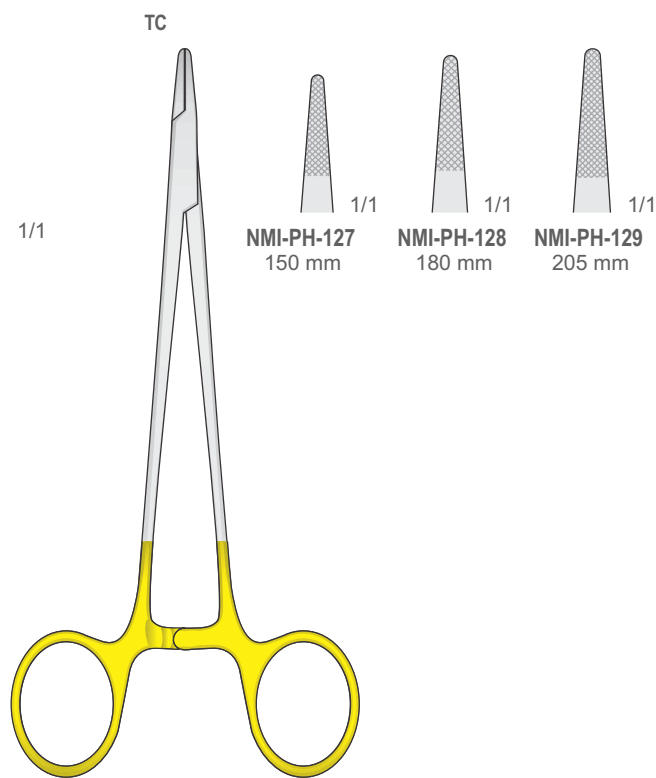


MICRO-VASCULAR  
NMI-PH-101/NMI-PH-102/NMI-PH-103

Vascular  
Vaskuläre  
Vasculaire  
Vasculares  
Vascolari



MAYO-HEGAR  
NMI-PH-120/NMI-PH-121/NMI-PH-122

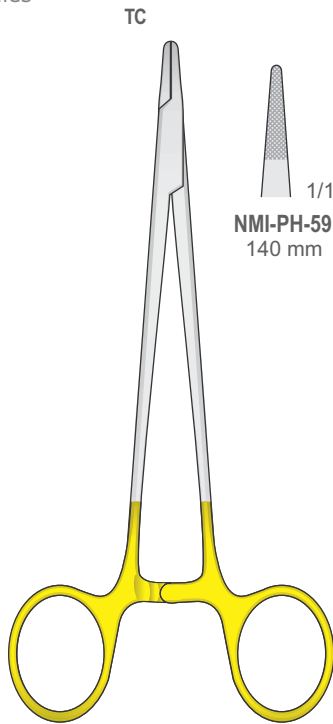


MAYO-HEGAR-FINO  
NMI-PH-127/NMI-PH-128/NMI-PH-129



Nadelhalter  
Needle Holders  
Port'aghi  
Portaagujas  
Porte aiguilles

**Tungsten-Carbide Inserts**  
Mit Hartmetalleinsätzen  
Plaquettes en carbure de tungstène  
Plaquetas de carburo de tungsteno  
Inserti in carburo di tungsteno



TC

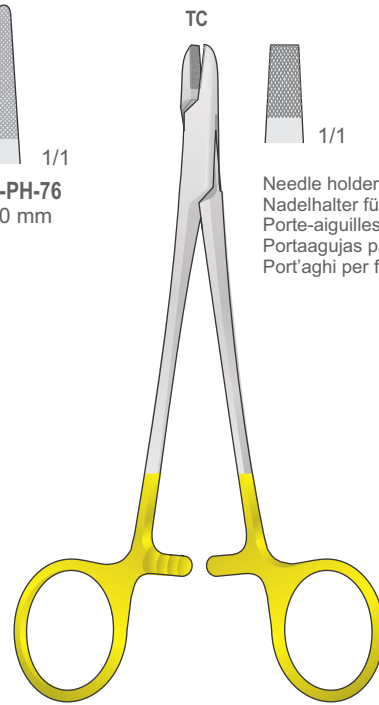
**NMI-PH-59**  
140 mm

**NMI-PH-72**  
160 mm

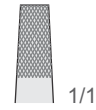
**NMI-PH-75**  
180 mm

**NMI-PH-76**  
200 mm

HEGAR  
NMI-PH-59/NMI-PH-72/NMI-PH-75/NMI-PH-76

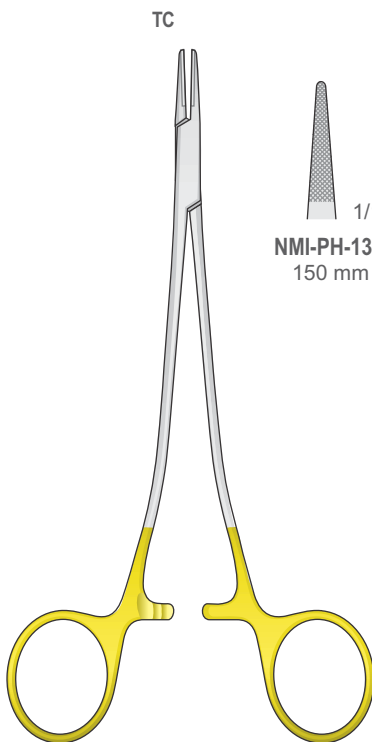


TC



Needle holders for wire  
Nadelhalter für drähte  
Porte-aiguilles pour fil métallique  
Portaagujas para hilo metálico  
Port'aghi per fili metallici

**NMI-PH-58**  
150 mm



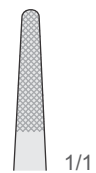
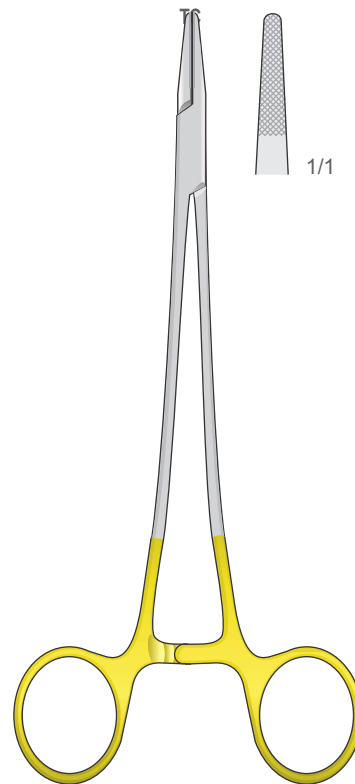
TC

**NMI-PH-132**  
150 mm

**NMI-PH-133**  
180 mm

**NMI-PH-134**  
210 mm

SAROT  
NMI-PH-132/NMI-PH-133/NMI-PH-134

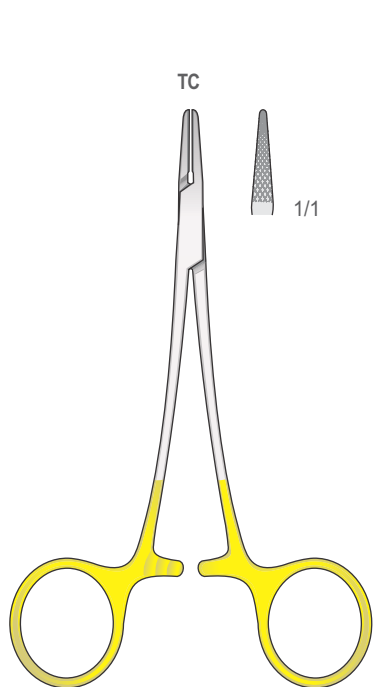


CRILE-WOOD  
**NMI-PH-77**  
180 mm

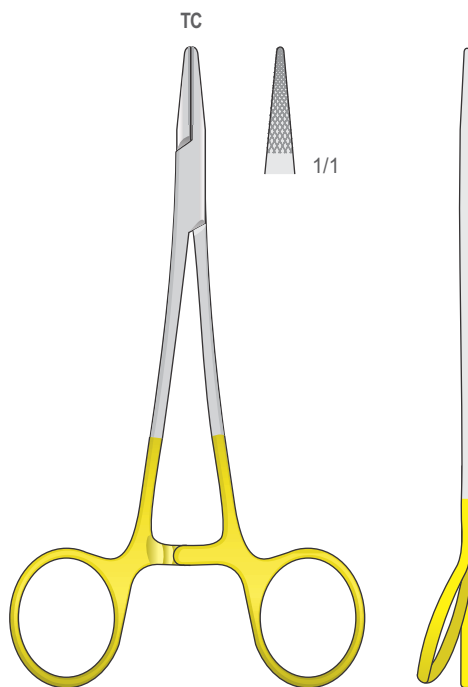


**Tungsten-Carbide Inserts**  
Mit Hartmetalleinsätzen  
Plaquettes en carbure de tungstène  
Plaquetas de carburo de tungsteno  
Inserti in carburo di tungsteno

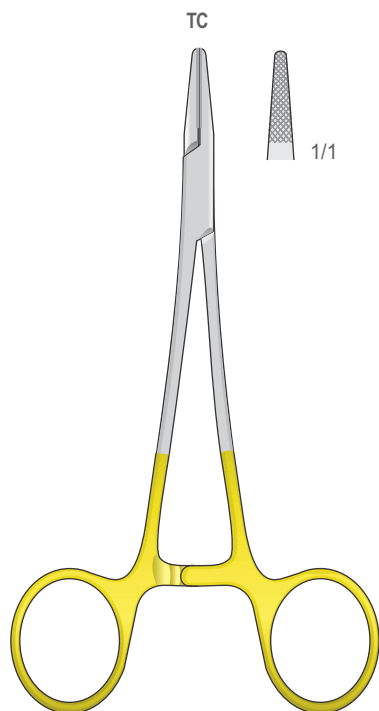
Nadelhalter  
Needle Holders  
Port'aghi  
Portaagujas  
Porte aiguilles



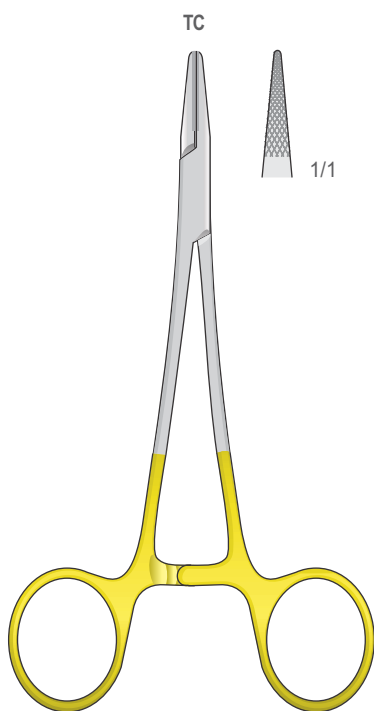
**NMI-PH-99**  
120 mm



**CRILE-WOOD**  
**NMI-PH-100**  
150 mm



**BABY-CRILE-WOOD**  
**NMI-PH-54**  
150 mm



**CRILE-WOOD**  
**NMI-PH-71**  
150 mm

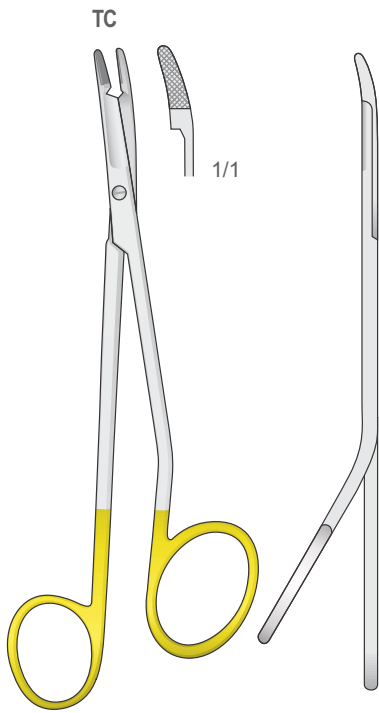


**CRILE-WOOD**  
**NMI-PH-90**  
150 mm

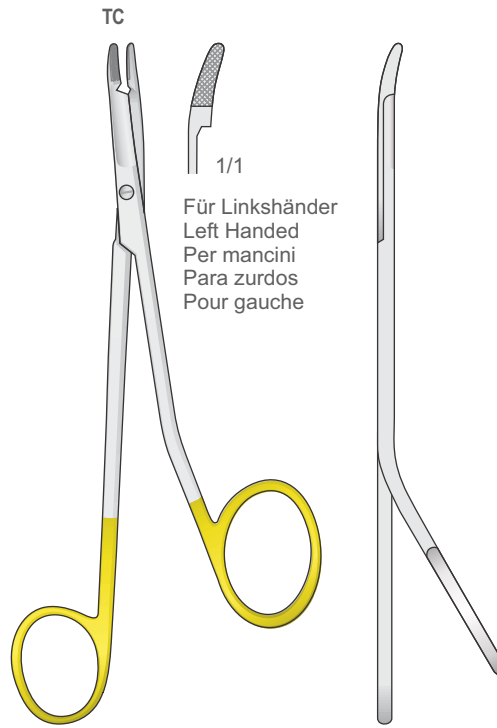


Nadelhalter  
Needle Holders  
Port'aghi  
Portaagujas  
Porte aiguilles

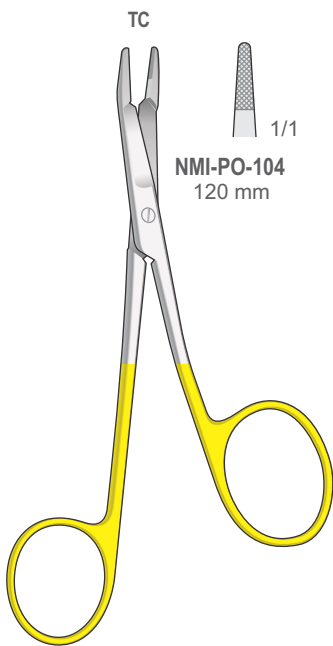
**Tungsten-Carbide Inserts**  
Mit Hartmetalleinsätzen  
Plaquettes en carbure de tungstène  
Plaquetas de carburo de tungsteno  
Inserti in carburo di tungsteno



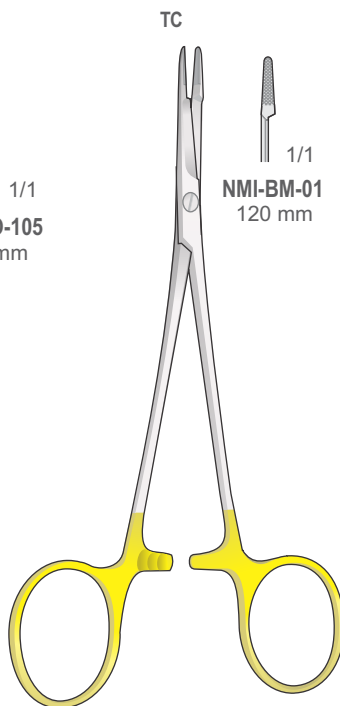
**MINI-GILLIES**  
**NMI-PO-99**  
145 mm



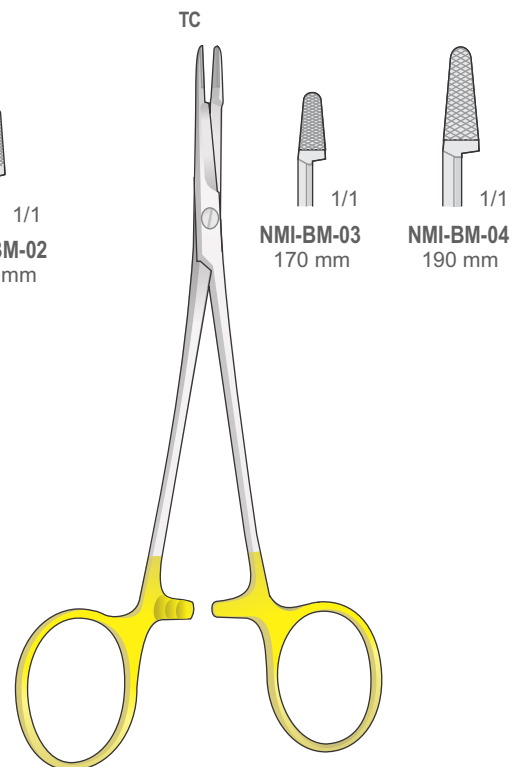
**MINI-GILLIES**  
**NMI-PO-99L**  
145 mm



**FOSTER-GILLIES**  
**NMI-PO-104/NMI-PO-105**  
120 mm



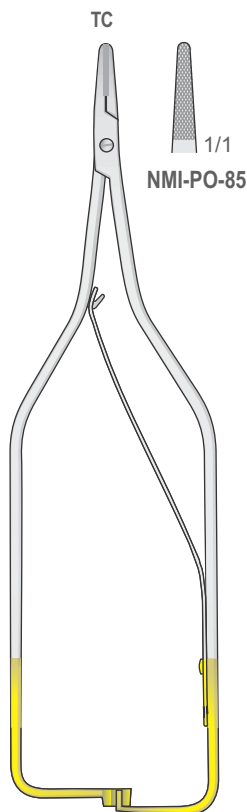
**OLSEN-HEGAR**  
**NMI-BM-01/NMI-BM-02**



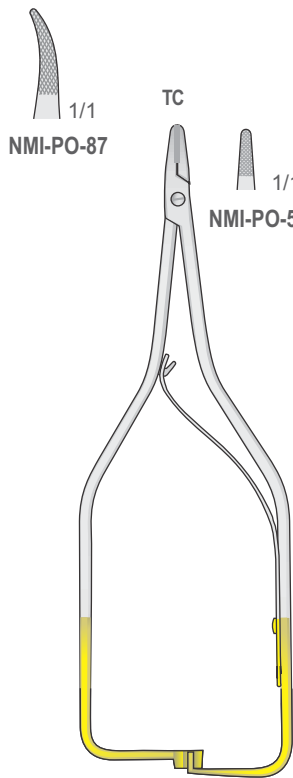
**OLSEN-HEGAR**  
**NMI-BM-03/NMI-BM-04**



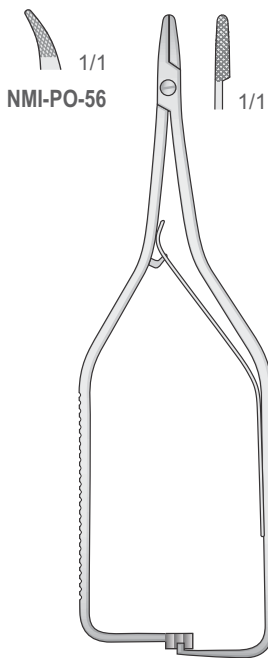
Nadelhalter  
Needle Holders  
Port'aghi  
Portaagujas  
Porte aiguilles



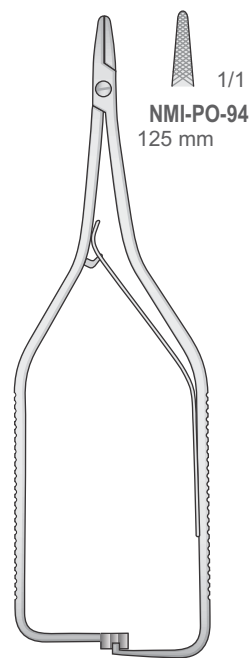
ARRUGA  
NMI-PO-85/NMI-PO-87  
160 mm



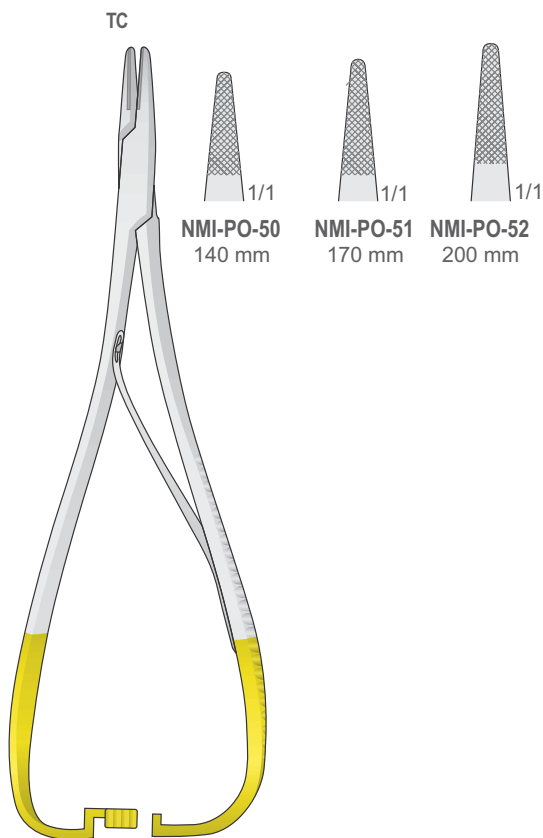
BOYNTON  
NMI-PO-55/NMI-PO-56  
120 mm



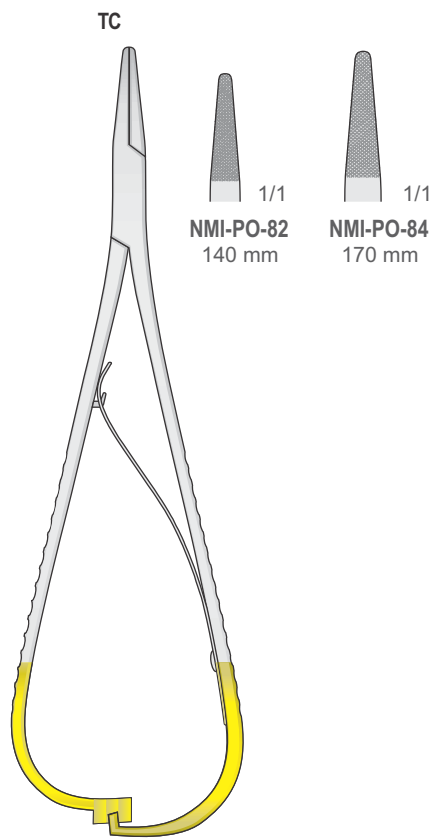
BOYNTON  
NMI-PO-88  
120 mm



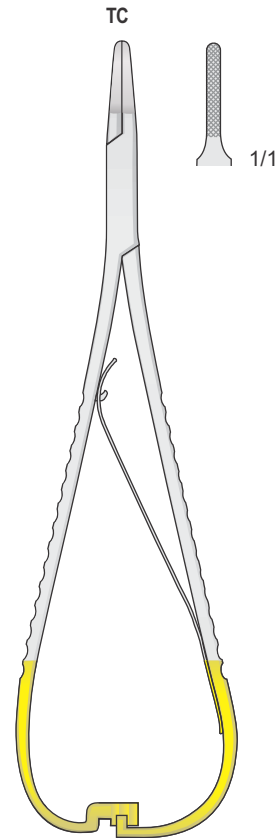
BOYNTON  
NMI-PO-94  
125 mm



MATHIEU  
NMI-PO-50/NMI-PO-52



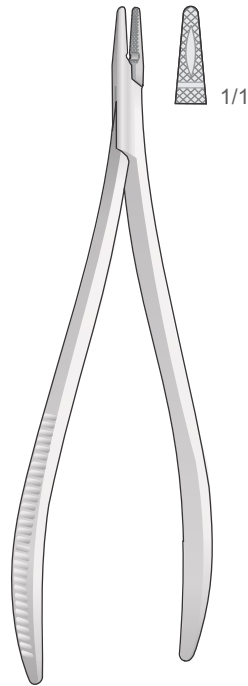
MATHIEU  
NMI-PO-82/NMI-PO-84



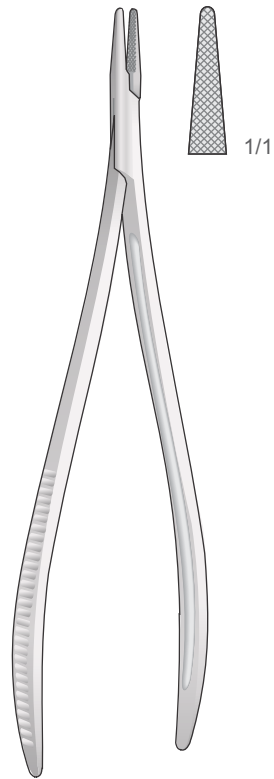
LICHTENBERG  
NMI-PO-86  
175 mm



Nadelhalter  
Needle Holders  
Port'aghi  
Portaagujas  
Porte aiguilles

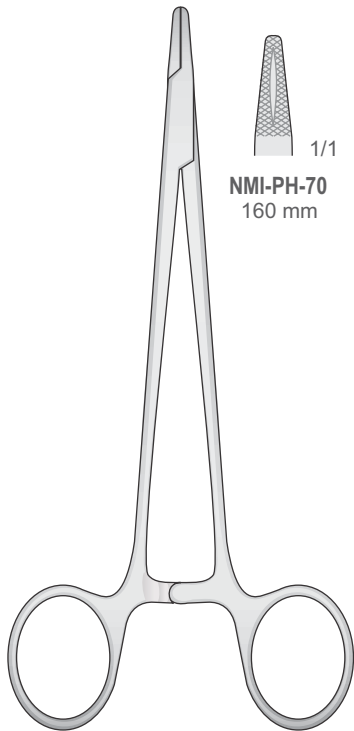


CRILE  
NMI-PO-37  
150 mm

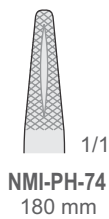


TÖNNIS  
NMI-PO-38  
190 mm

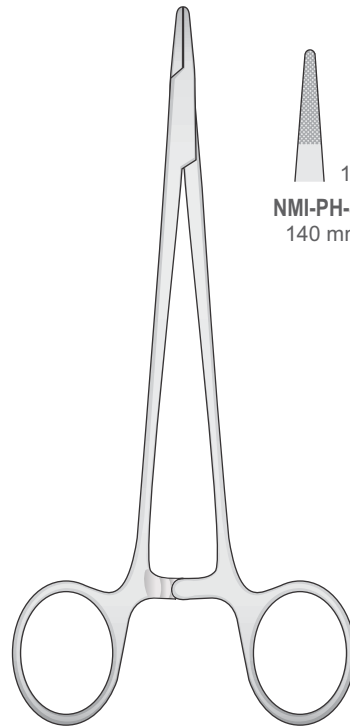
Schlankesmodell - Delicate pattern - Modello fine  
Modelo delegado - Modèle fin



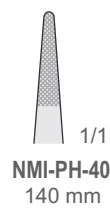
HEGAR  
NMI-PH-70/NMI-PH-74



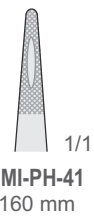
NMI-PH-74  
180 mm



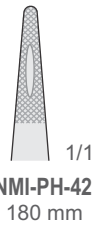
MAYO-HEGAR  
NMI-PH-40/NMI-PH-42



NMI-PH-40  
140 mm



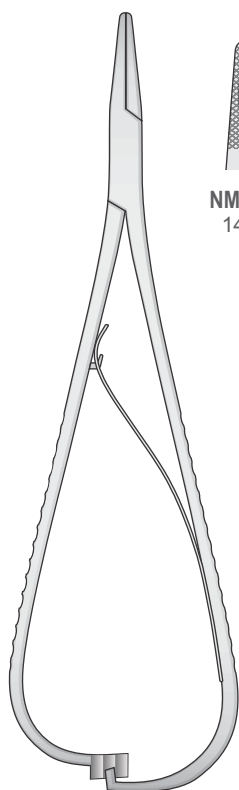
NMI-PH-41  
160 mm



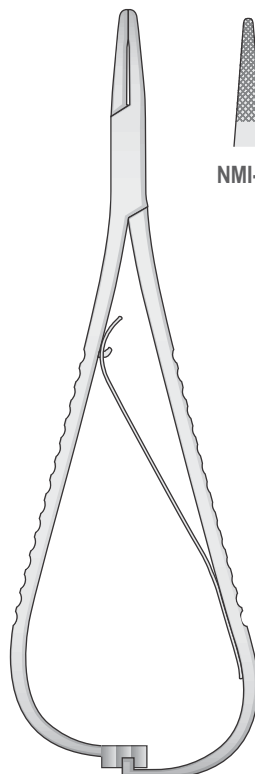
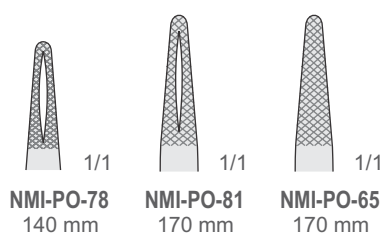
NMI-PH-42  
180 mm



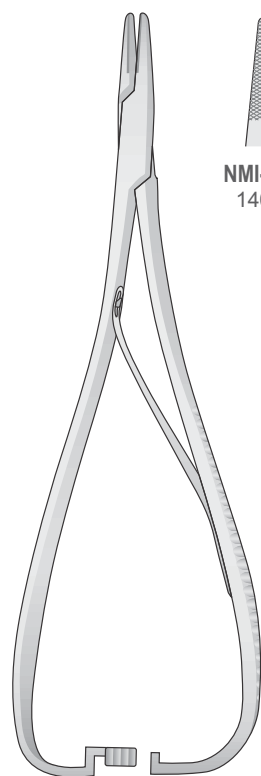
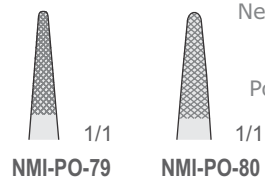
Nadelhalter  
Needle Holders  
Port'aghi  
Portaagujas  
Porte aiguilles



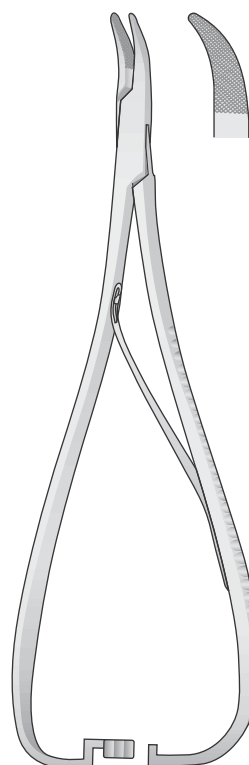
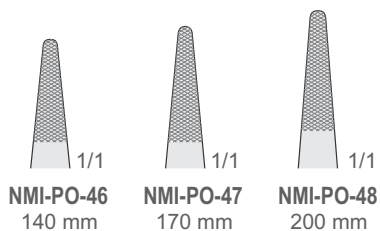
MATHIEU  
NMI-PO-65/NMI-PO-81



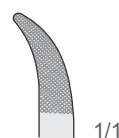
MATHIEU  
NMI-PO-79/NMI-PO-80  
140 mm



MATHIEU  
NMI-PO-46/NMI-PO-48

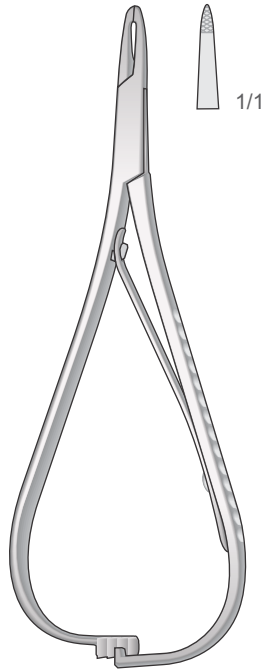


NMI-PO-40  
140 mm

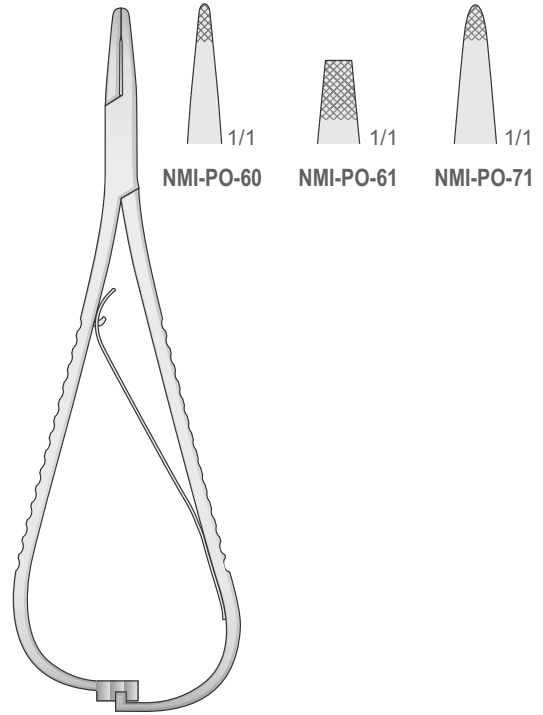




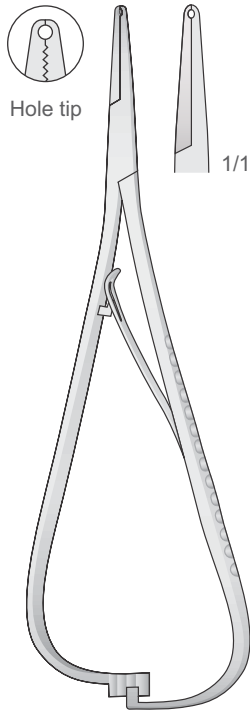
Nadelhalter  
Needle Holders  
Port'aghi  
Portaagujas  
Porte aiguilles



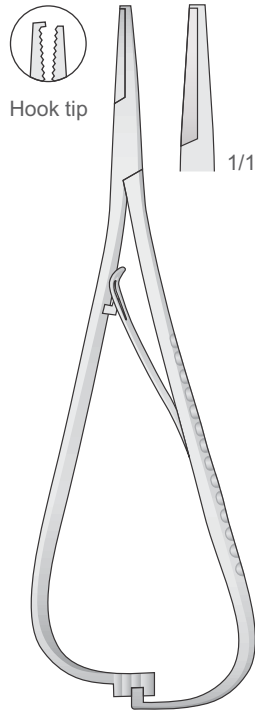
MATHIEU  
NMI-PO-45  
125 mm



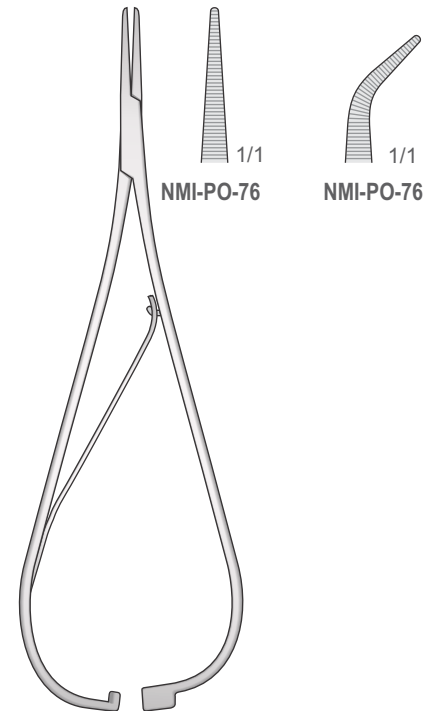
MATHIEU  
NMI-PO-60/NMI-PO-71  
140 mm



SMAHA  
NMI-PO-68  
140 mm



SMAHA  
NMI-PO-69  
140 mm



SMAHA  
NMI-PO-76/NMI-PO-77  
140 mm

# DENTAL Instruments

Extracting Forceps

Root Elevators

Scalpel Blades and Handles

Surgical Scissors

Tissue and Dressing Forceps

Needle Holders

Hemostatic Forceps | Towel Clamps

Retractors | Mouth Gags

Implantology

Periosteal | Curettes | Rongeurs

Dental Restoration | Periodontology

Suction Tube

Orthodontics

Crown Instruments | Laboratory

Instrument Maintenance | Sterilization

## Hemostatic Forceps

Arterienklemmen

Pinces hémostatiques

Pinzas hemostáticas

Pinzette emostatiche

## Towel Clamps

Tuchklemmen

Pinces fixe-compresses

Pinzas de campo

Fissateli

## Sponge and Dressing Forceps

Schwamm und Tamponzangen

Pinces pour éponges et à pansement

Pinzas para esponja y tampones

Pinze per tamponi e spunge

## Tissue Grasping Forceps

Gewebefasszangen

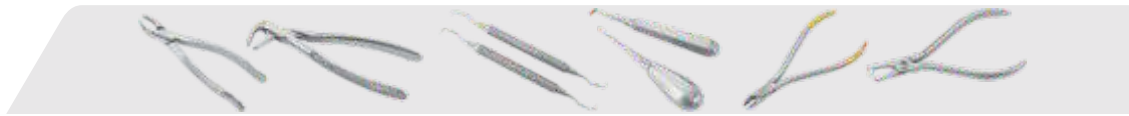
Pinces pour tissus

Pinzas para tejidos

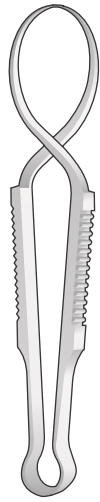
Pinze per tessuti

159-169

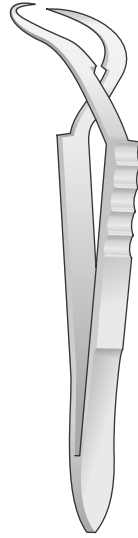




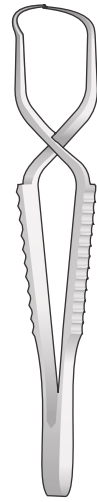
Tuchklemmen  
Towel Clamps  
Fissateli  
Pinzas de campo  
Pincas fixe-compresses



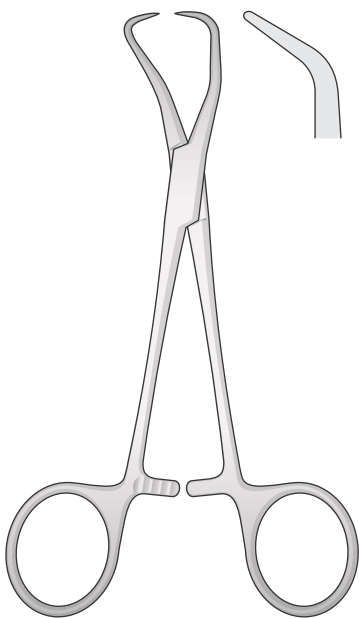
SCHAEDEL  
NMI-BF-38  
85 mm



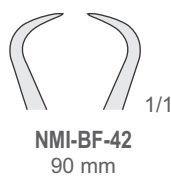
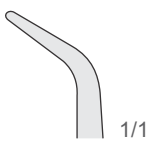
JONES  
NMI-BF-48  
90 mm



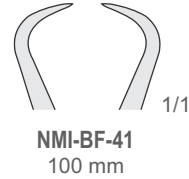
FAURE  
NMI-BF-40  
85 mm



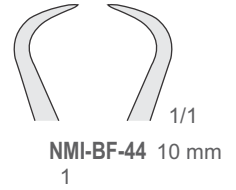
BACKHAUS  
NMI-BF-42/NMI-BF-46



NMI-BF-42  
90 mm



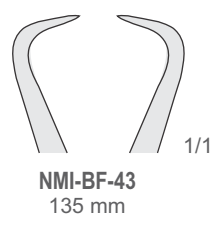
NMI-BF-41  
100 mm



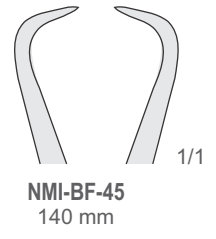
NMI-BF-44 10 mm  
1



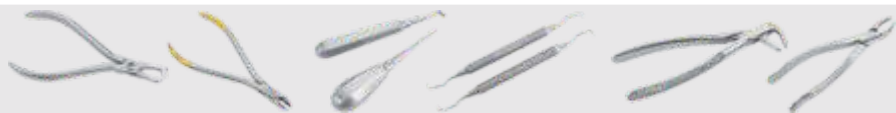
NMI-BF-46  
130 mm



NMI-BF-43  
135 mm

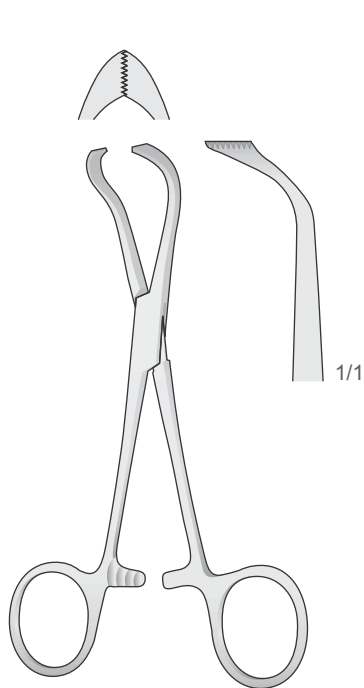


NMI-BF-45  
140 mm

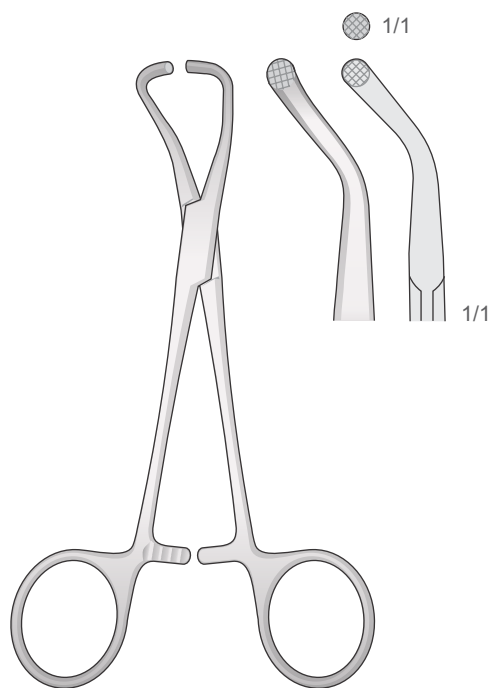


Tuchklemmen  
Towel Clamps  
Fissateli  
Pinzas de campo  
Pincas fixe-compresses

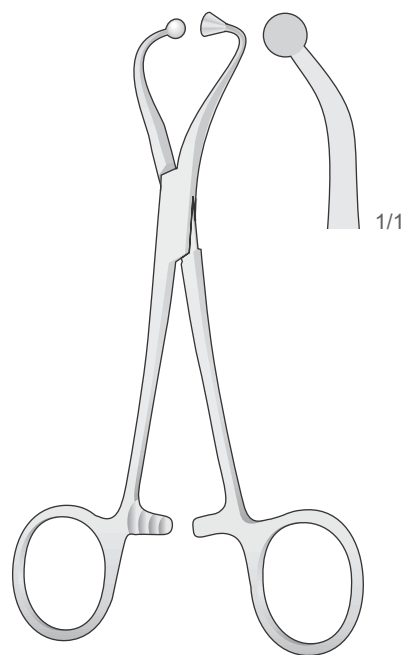
Für Papiertücher  
For paper cloths  
Per teli di carta  
Para paños  
Pour papier



**LORNA**  
**NMI-BF-50**  
100 mm



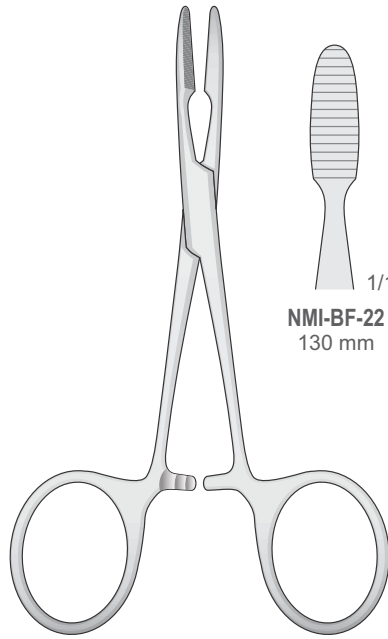
**NMI-BF-52**  
130 mm



**NMI-BF-75**  
140 mm



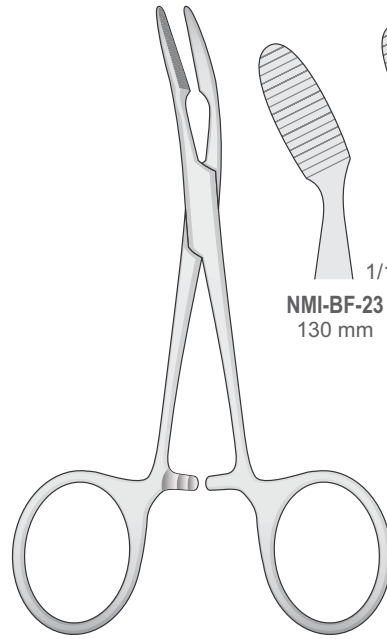
Schwamm und Tamponzangen  
Sponge and Dressing Forceps  
Pinze per tamponi e spunge  
Pinzas para esponja y tampones  
Pinces pour éponges et à pansement



NMI-BF-22  
130 mm

NMI-BF-24  
140 mm

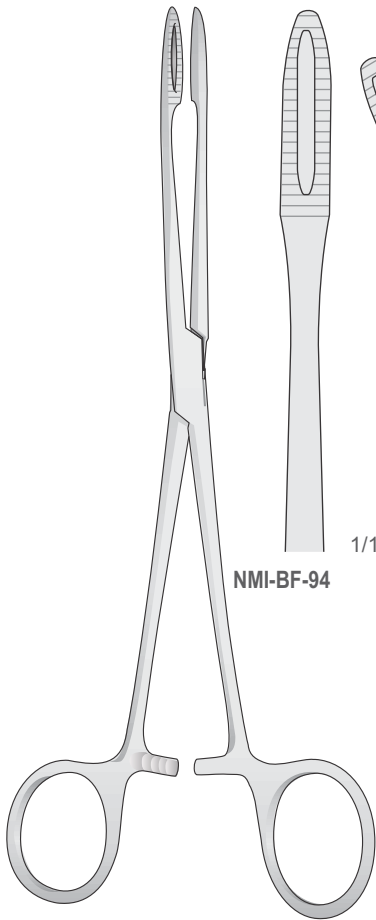
PEAN-MURPHY  
NMI-BF-22/NMI-BF-24



NMI-BF-23  
130 mm

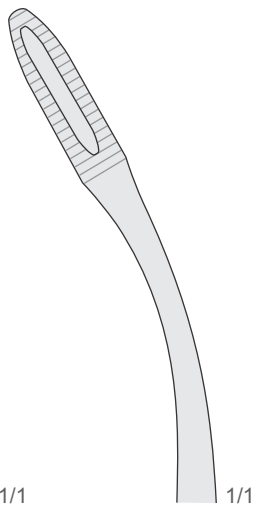
NMI-BF-25  
140 mm

PEAN-MURPHY  
NMI-BF-23/NMI-BF-25

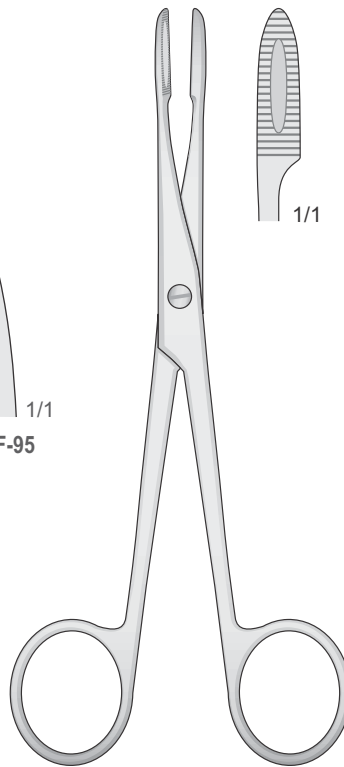


NMI-BF-94  
1/1

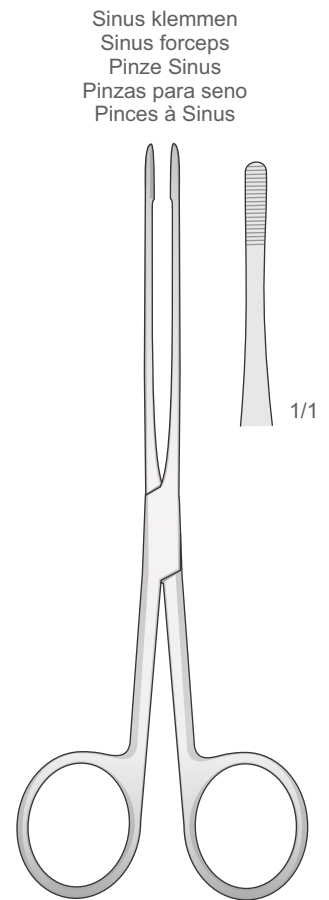
GROSS  
NMI-BF-94/NMI-BF-95  
200 mm



NMI-BF-95  
1/1

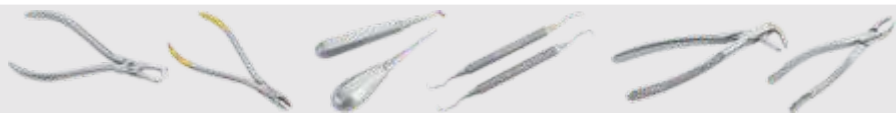


GROSS  
NMI-BF-10 130 mm  
NMI-BF-12 160 mm

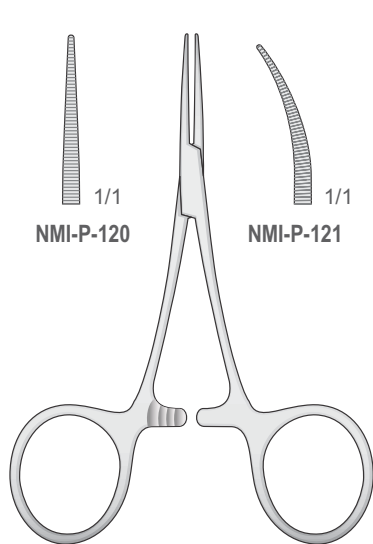


Sinus klemmen  
Sinus forceps  
Pinze Sinus  
Pinzas para seno  
Pinces à Sinus

LISTER  
NMI-BF-20  
150 mm



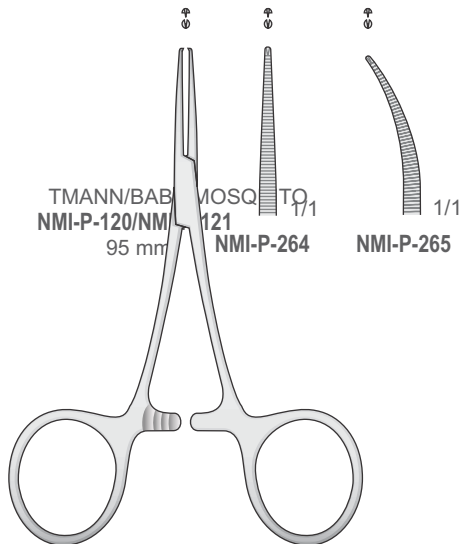
Arterienklemmen  
Hemostatic Forceps  
Pinzas emostatiche  
Pinzas hemostáticas  
Pincas hémostatiques



NMI-P-120

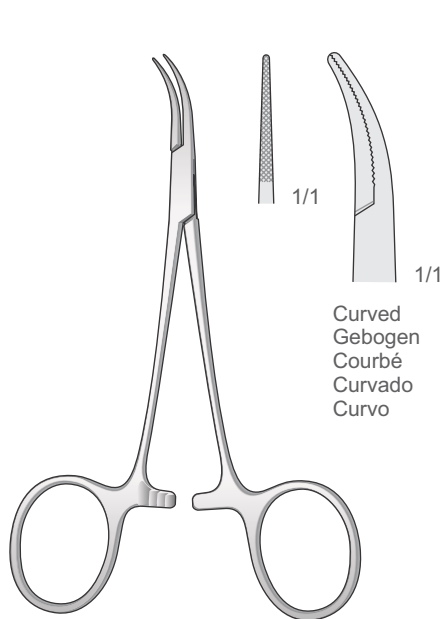
NMI-P-121

HAR

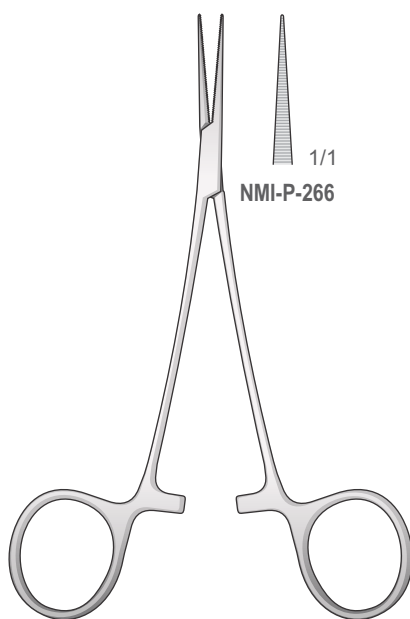


HARTMANN/BABY-MOSQUITO  
NMI-P-120/NMI-P-121  
95 mm

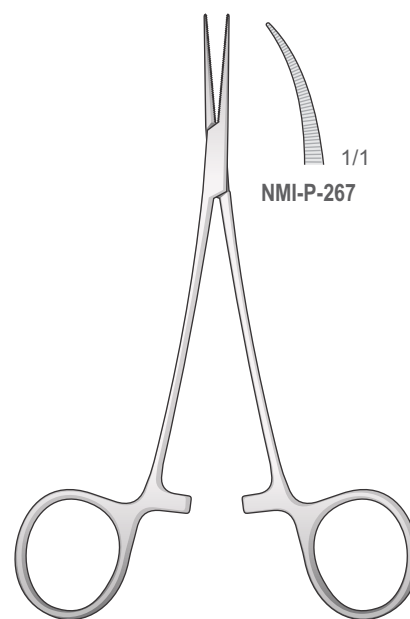
HARTMANN/BABY-MOSQUITO  
NMI-P-264/NMI-P-265  
95 mm



DANDY-MOSQUITO  
NMI-P-332  
120 mm



JACOBSON-MICRO  
NMI-P-266  
130 mm

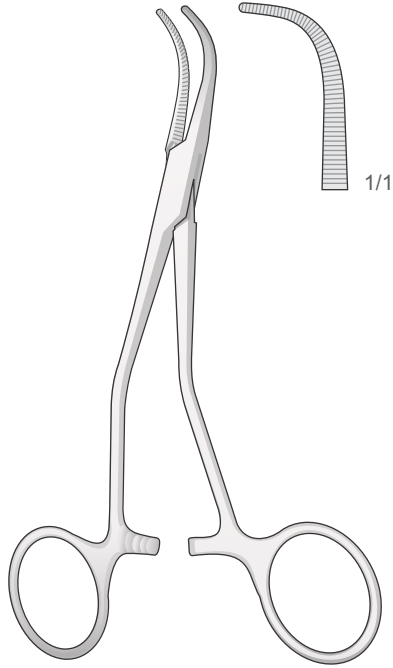


JACOBSON-MICRO  
NMI-P-267  
130 mm

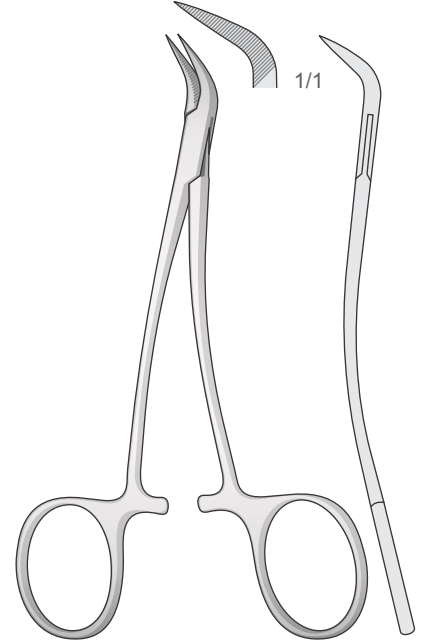
Curved  
Gebogen  
Courbé  
Curvado  
Curvo



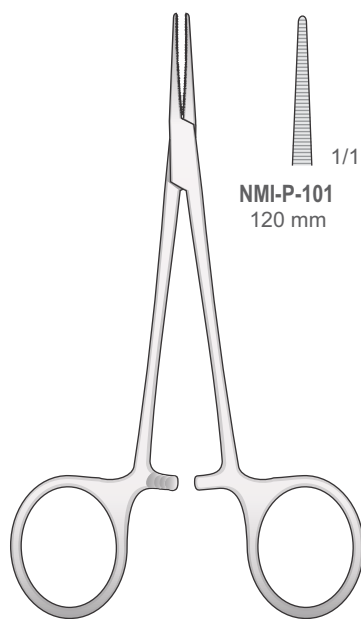
Arterienklemmen  
Hemostatic Forceps  
Pinze emostatiche  
Pinzas hemostáticas  
Pincas hémostatiques



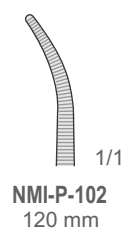
**NMI-P-15**  
130 mm



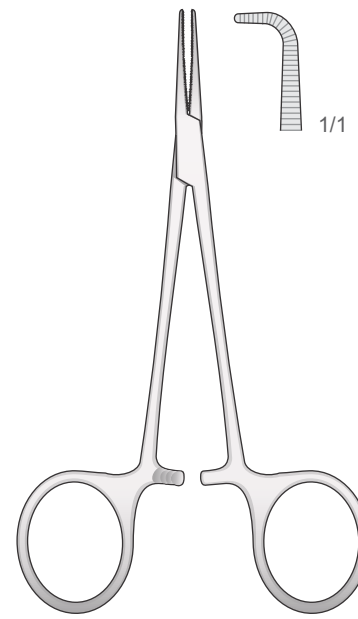
**PEET**  
**NMI-DR-40**  
120 mm



**MICRO-HALSTED**  
**NMI-P-101/NMI-P-102**



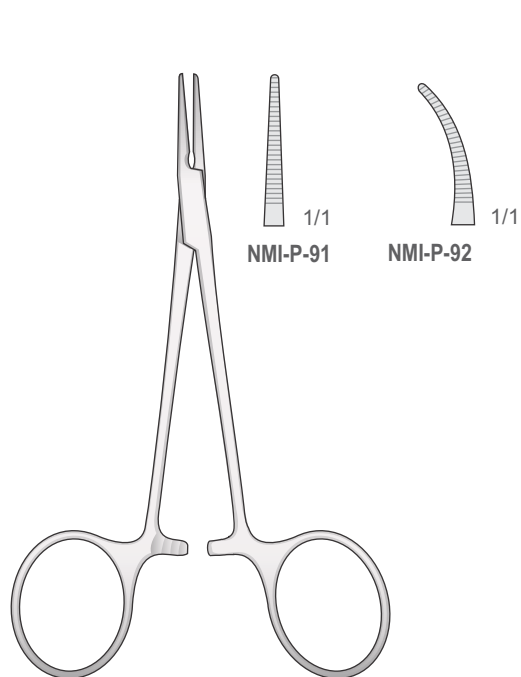
**NMI-P-102**  
120 mm



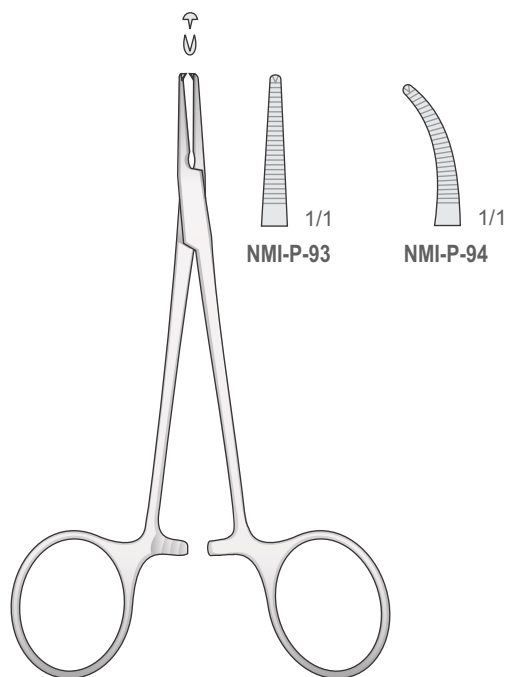
**MICRO-HALSTED**  
**NMI-P-135**  
15 mm  
1



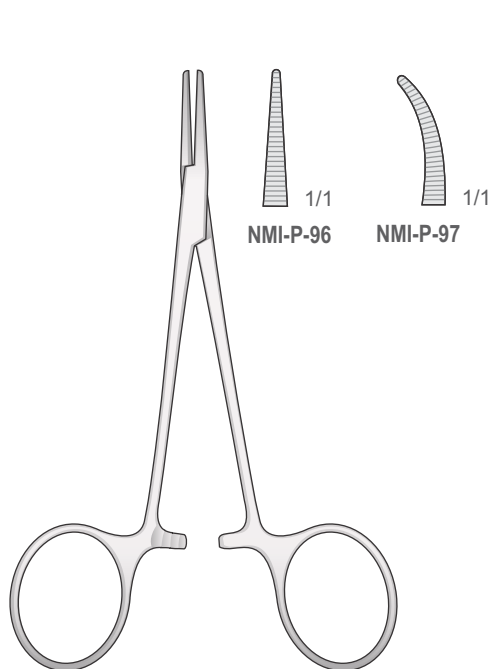
Arterienklemmen  
Hemostatic Forceps  
Pinze emostatiche  
Pinzas hemostáticas  
Pincas hémostatiques



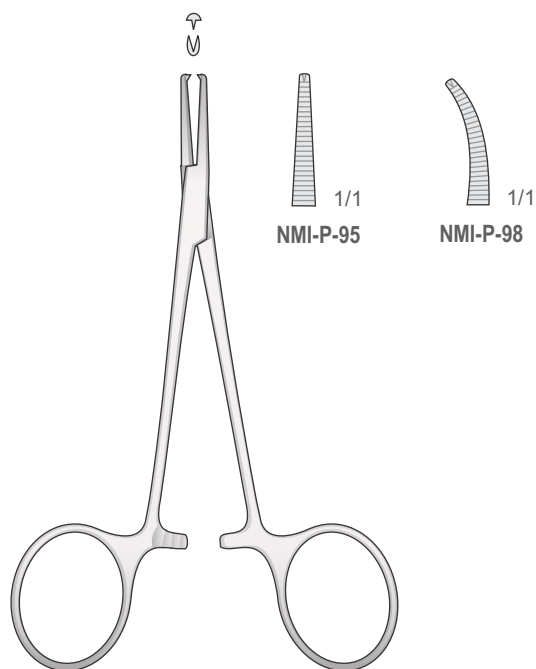
HALSTED  
NMI-P-91/NMI-P-92  
125 mm



HALSTED  
NMI-P-93/NMI-P-94  
125 mm



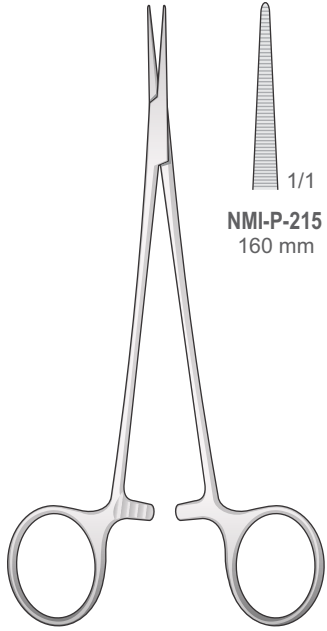
HALSTED-MOSQUITO  
NMI-P-96/NMI-P-97  
120 mm



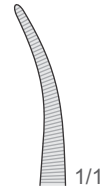
HALSTED-MOSQUITO  
NMI-P-95/NMI-P-98  
120 mm



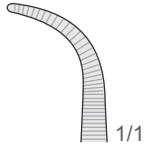
Arterienklemmen  
Hemostatic Forceps  
Pinze emostatiche  
Pinzas hemostáticas  
Pinces hémostatiques



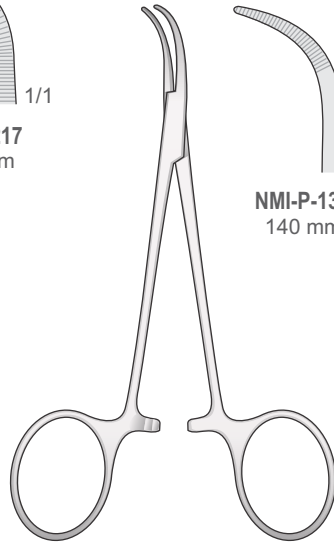
**NMI-P-215**  
160 mm



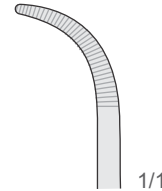
**NMI-P-216**  
160 mm



**NMI-P-217**  
160 mm



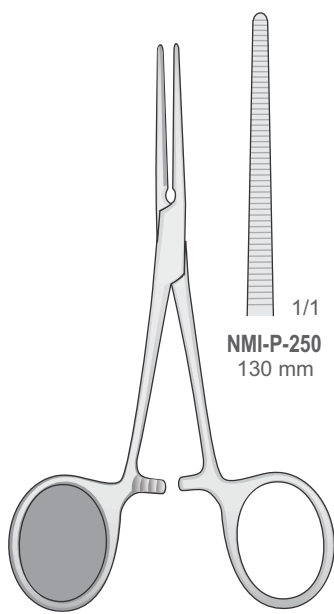
**NMI-P-136**  
140 mm



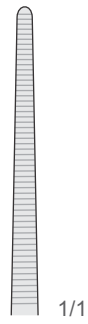
**NMI-P-137**  
180 mm

**NMI-P-215/NMI-P-217**  
160 mm

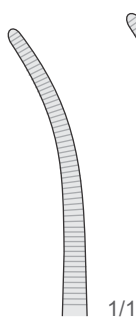
**BABY-MIXTER**  
**NMI-P-136/NMI-P-137**



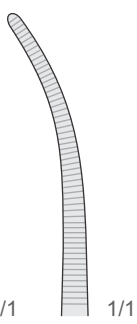
**NMI-P-250**  
130 mm



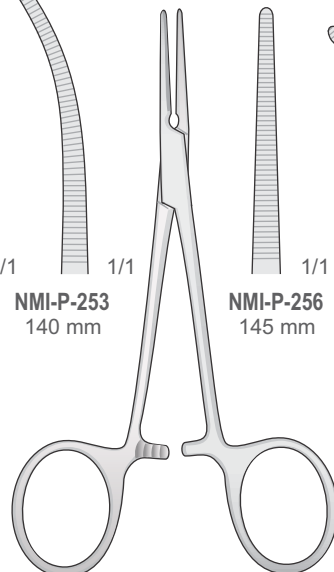
**NMI-P-252**  
140 mm



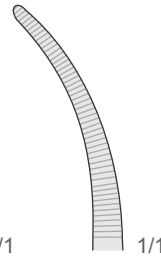
**NMI-P-251**  
130 mm



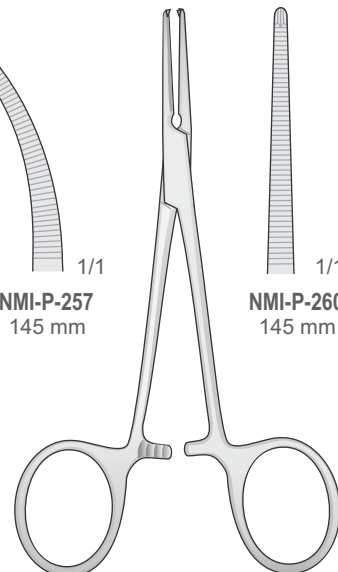
**NMI-P-253**  
140 mm



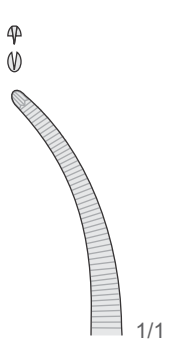
**NMI-P-256**  
145 mm



**NMI-P-257**  
145 mm



**NMI-P-260**  
145 mm

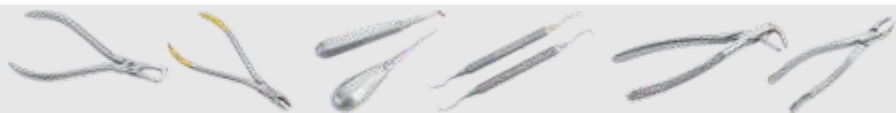


**NMI-P-261**  
145 mm

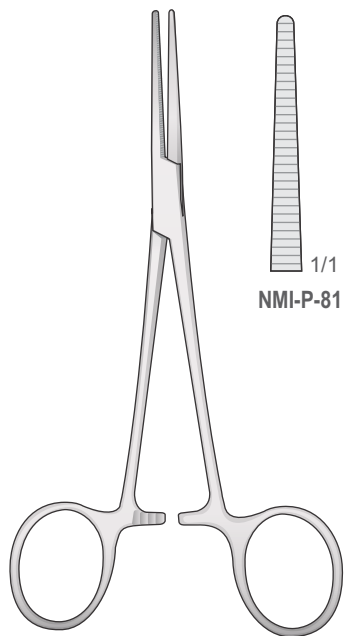
**PEAN**  
**NMI-P-250/NMI-P-253**

**PEAN**  
**NMI-P-256/NMI-P-257**

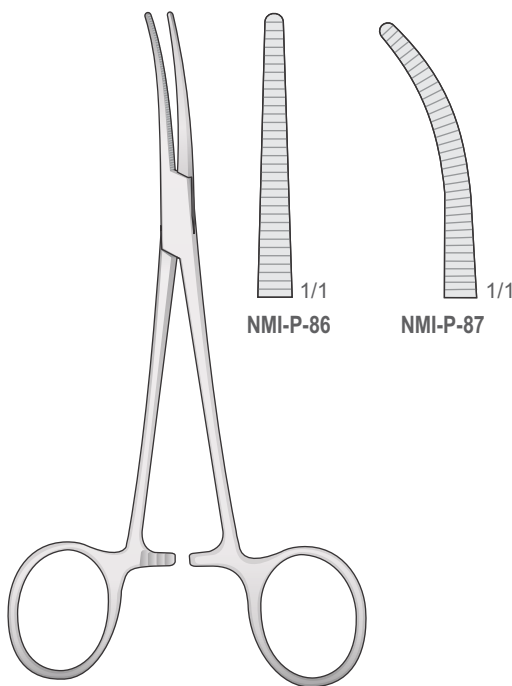
**KOCHER**  
**NMI-P-260/NMI-P-261**



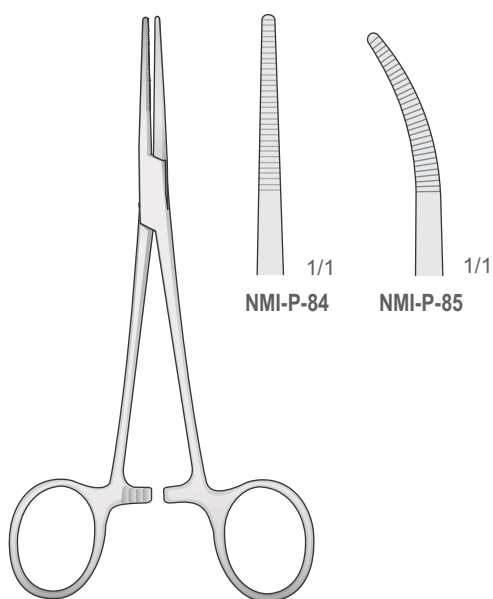
Arterienklemmen  
Hemostatic Forceps  
Pinze emostatiche  
Pinzas hemostáticas  
Pinces hémostatiques



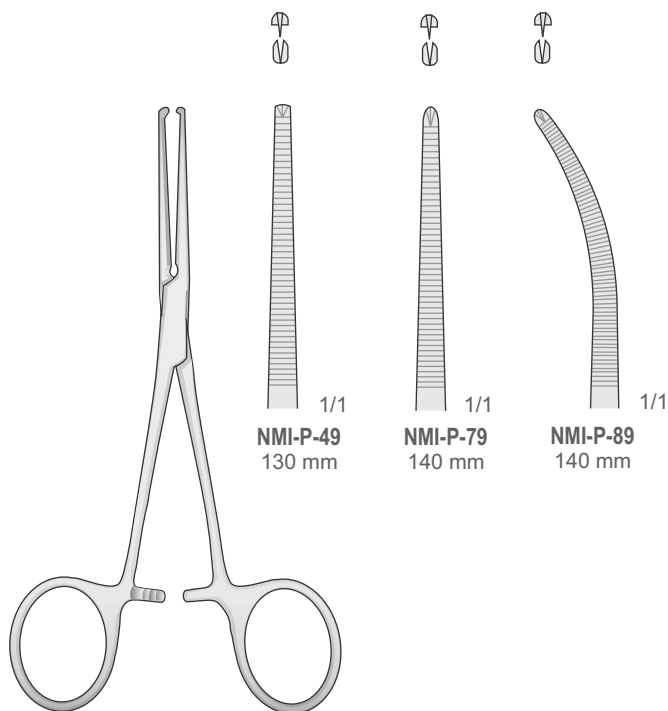
CRILE  
NMI-P-81/NMI-P-82  
140 mm



CRILE  
NMI-P-86/NMI-P-87  
160 mm



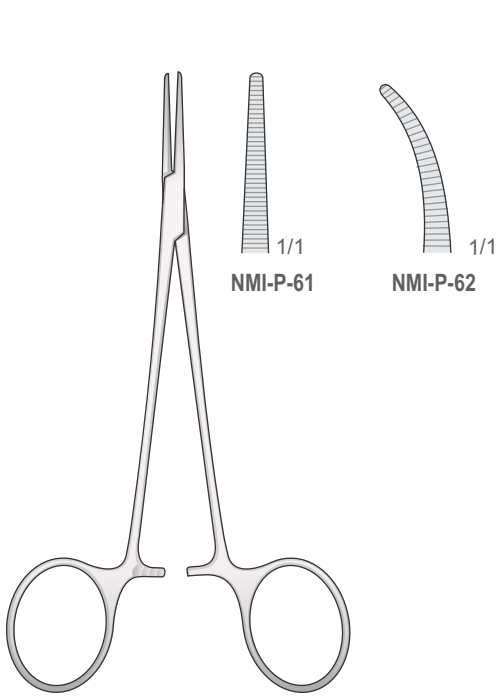
KELLY  
NMI-P-84/NMI-P-85  
140 mm



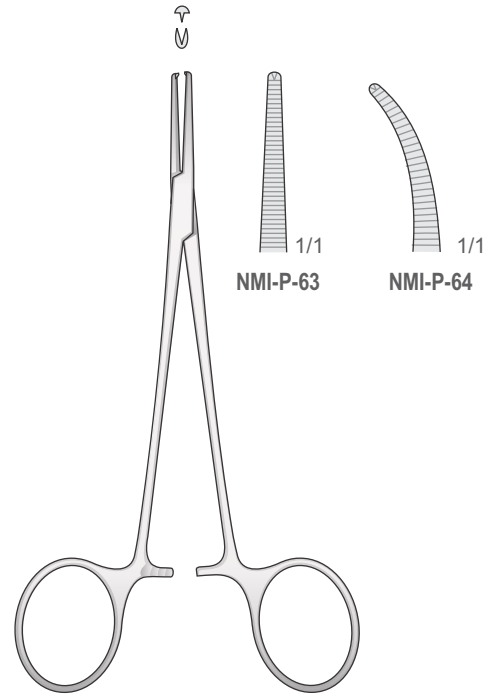
KOCHER  
NMI-P-49/NMI-P-89



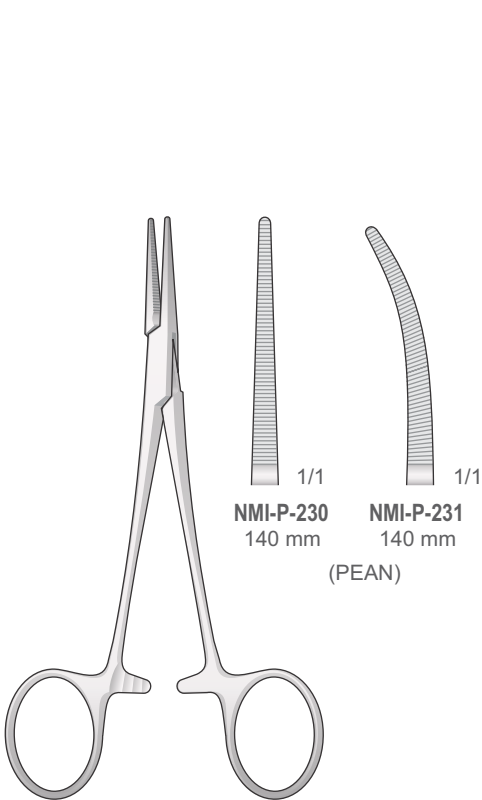
Arterienklemmen  
Hemostatic Forceps  
Pinze emostatiche  
Pinzas hemostáticas  
Pincas hémostatiques



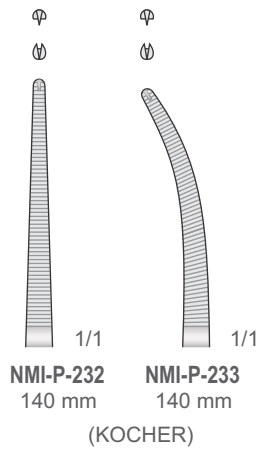
LERICHE  
NMI-P-61/NMI-P-62  
150 mm



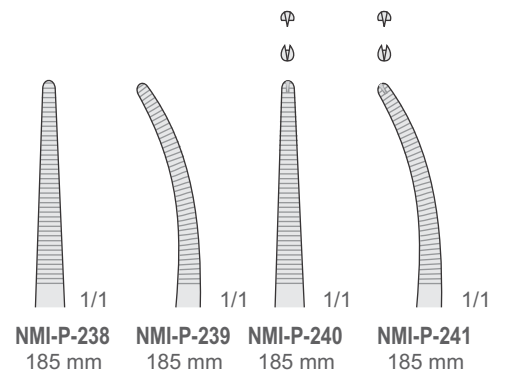
LERICHE  
NMI-P-63/NMI-P-64  
150 mm



BABY-CRILE  
NMI-P-230/NMI-P-233  
140 mm

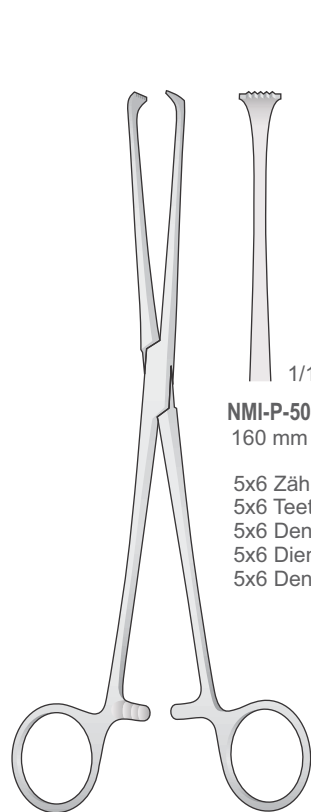


HALSTED  
NMI-P-238/NMI-P-241  
185 mm





Gewebefasszangen  
Tissue Grasping Forceps  
Pinze per tessuti  
Pinzas para tejidos  
Pinces pour tissus



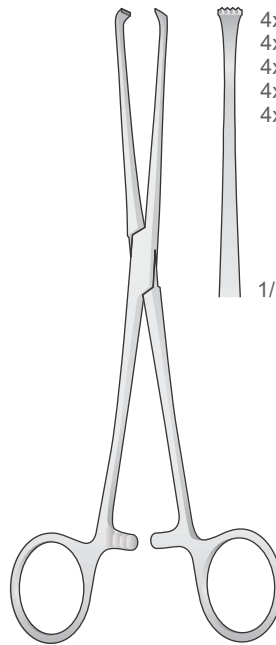
**ALLIS**  
**NMI-P-50/NMI-P-52**

**ATRAUMA**

**NMI-P-50**  
160 mm  
5x6 Zähne  
5x6 Teeth  
5x6 Denti  
5x6 Dientes  
5x6 Dents

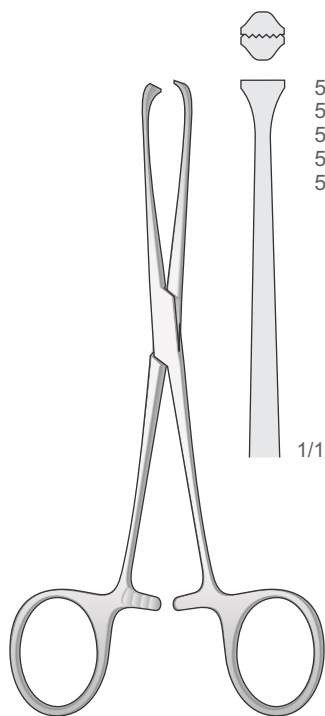
**NMI-P-52**  
160 mm  
1/1

**NMI-P-1 15**  
200 mm  
5x6 Zähne  
5x6 Teeth  
5x6 Denti  
5x6 Dientes  
5x6 Dents



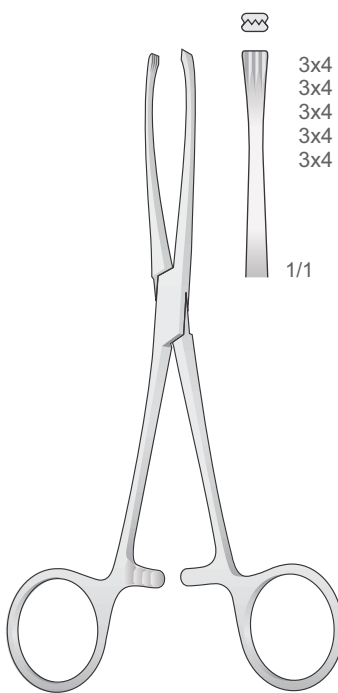
**BABY-ALLIS**  
**NMI-P-100**  
130 mm

4x5 Zähne  
4x5 Teeth  
4x5 Denti  
4x5 Dientes  
4x5 Dents  
1/1



**BOYS-ALLIS**  
**NMI-P-129**  
150 mm

5x6 Zähne  
5x6 Teeth  
5x6 Denti  
5x6 Dientes  
5x6 Dents  
1/1



**JUDD-ALLIS**  
**NMI-P-324**  
155 mm

3x4 Zähne  
3x4 Teeth  
3x4 Denti  
3x4 Dientes  
3x4 Dents  
1/1

# DENTAL Instruments

Extracting Forceps

Root Elevators

Scalpel Blades and Handles

Surgical Scissors

Tissue and Dressing Forceps

Needle Holders

Hemostatic Forceps | Towel Clamps

Retractors | Mouth Gags

Implantology

Periosteal | Curettes | Rongeurs

Dental Restoration | Periodontology

Suction Tube

Orthodontics

Crown Instruments | Laboratory

Instrument Maintenance | Sterilization

## Retractors

Retraktoren

Écarteurs

Separadores

Divaricatori

## Mouth Gags | Mouth Prop

Mundsperrer

Ouvre-bouche

Abrebocas

Apribocca

## Tongue Depressor

Zungendrücker

Abaisse-langue

Bajalengua

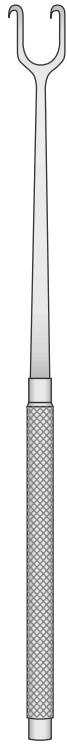
Abbassalingua

170-190

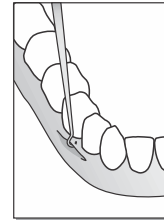
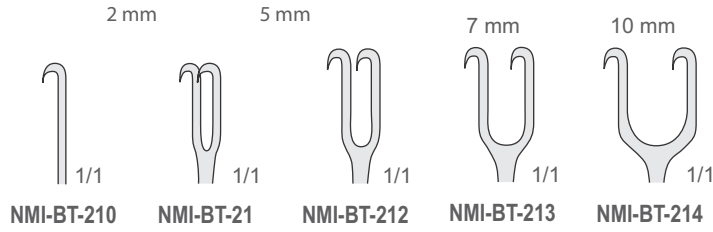




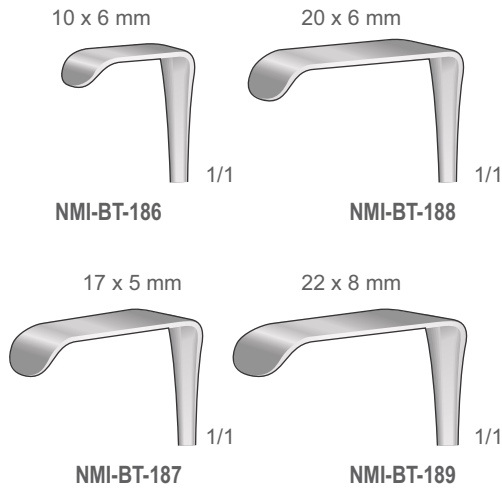
Wundhaken  
Retractors  
Divaricatori  
Separadores  
Écarteurs



**JOSEPH**  
**NMI-BT-210/NMI-BT-214**  
160 mm



**MINI-LANGENBECK**  
**NMI-BT-186/NMI-BT-189**  
160 mm

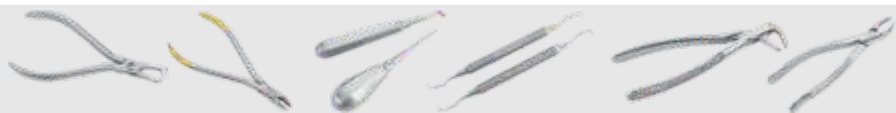


**GILLIES**  
**NMI-BT-15**  
180 mm

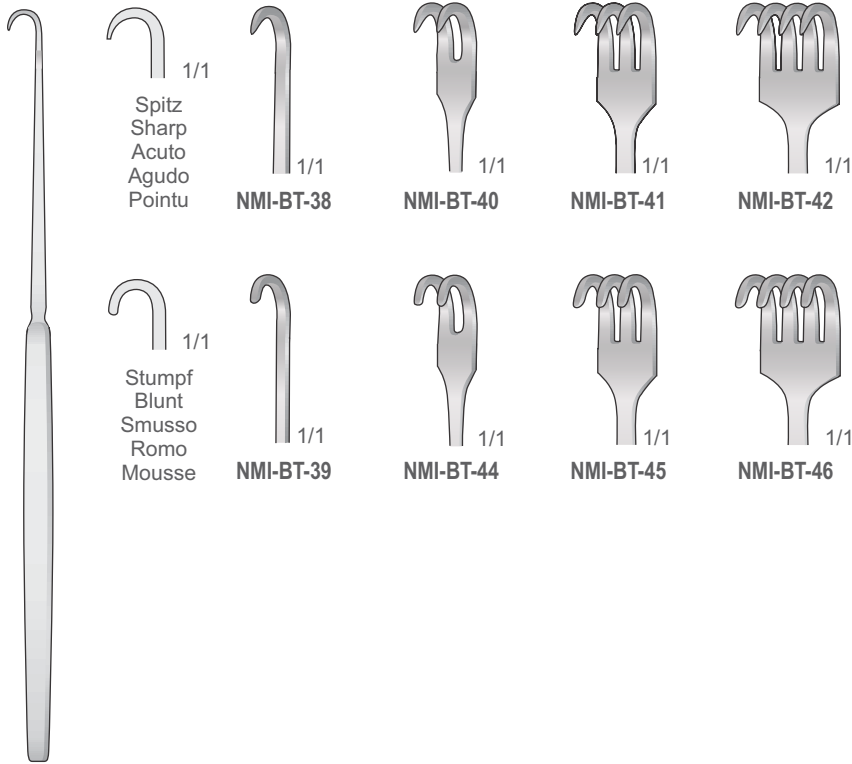


**GILLIES**  
**NMI-BT-16**  
180 mm





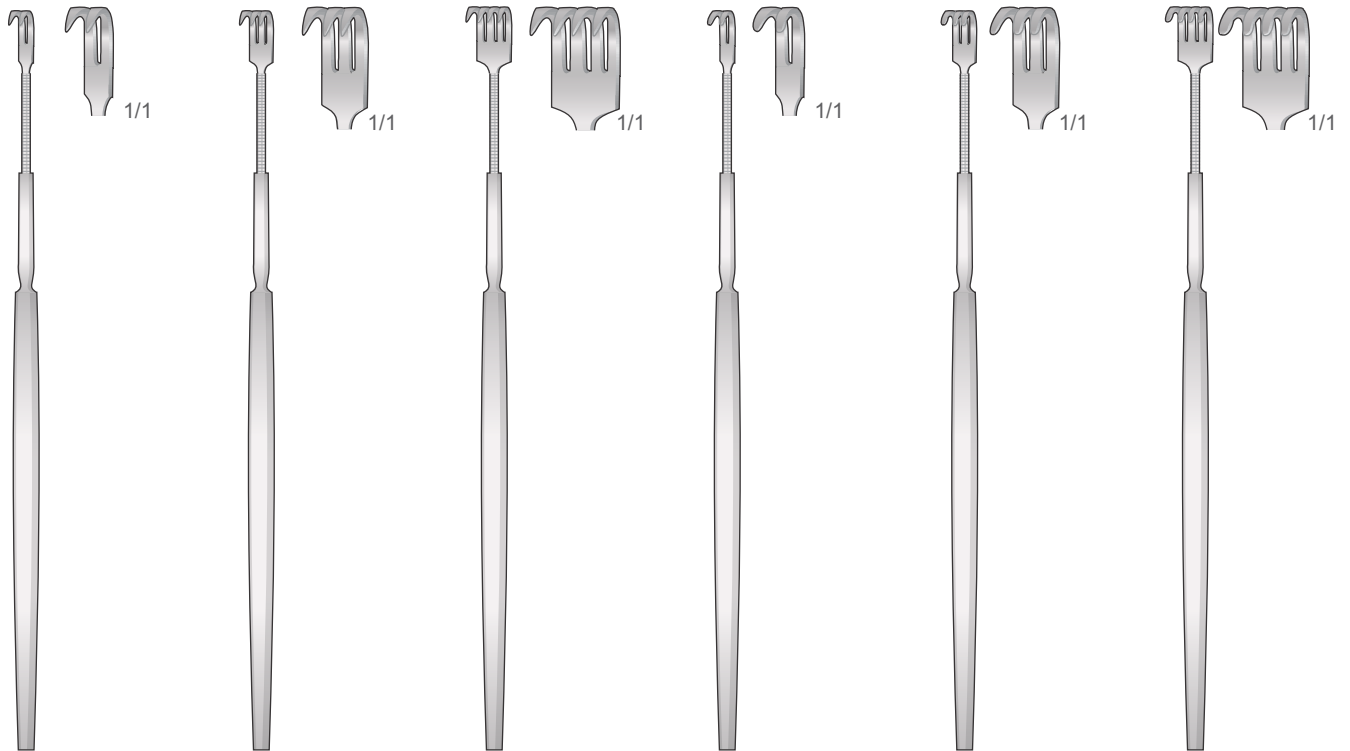
Wundhaken  
Retractors  
Divaricatori  
Separadores  
Écarteurs



**NMI-BT-38/NMI-BT-46**  
160 mm

Feine wundhaken flexibel-spitz  
Delicate retractors flexible-sharp  
Divaricatori delicati flessibili-acuti  
Separadores finos flexibles-agudos  
Écarteurs fins pointu flexible

Feine wundhaken flexibel-stumpf  
Delicate retractors flexible-blunt  
Divaricatori delicati flessibili-smussi  
Separadores finos flexibles-romos  
Écarteurs fins mousse flexible



**NMI-BT-50**  
150 mm

**NMI-BT-51**  
150 mm

**NMI-BT-52**  
150 mm

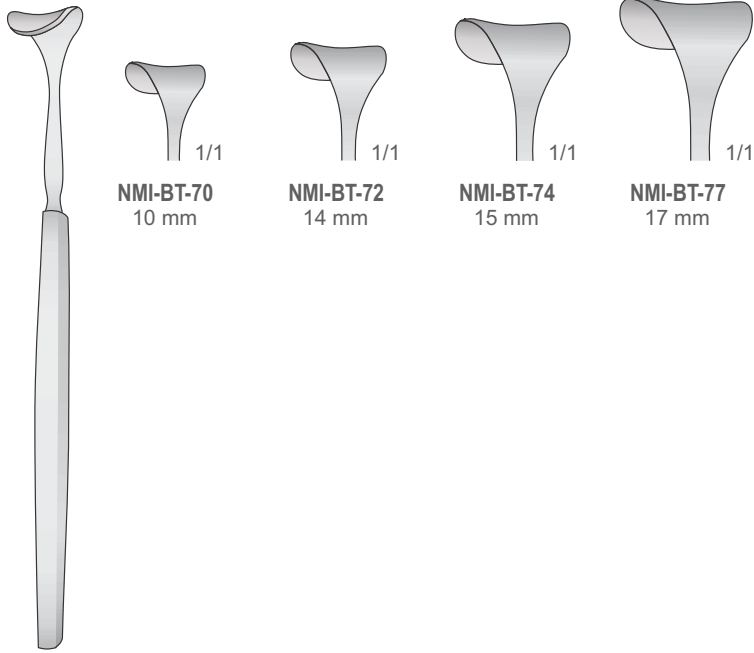
**NMI-BT-54**  
150 mm

**NMI-BT-55**  
150 mm

**NMI-BT-56**  
150 mm



Wundhaken  
Retractors  
Divaricatori  
Separadores  
Écarteurs



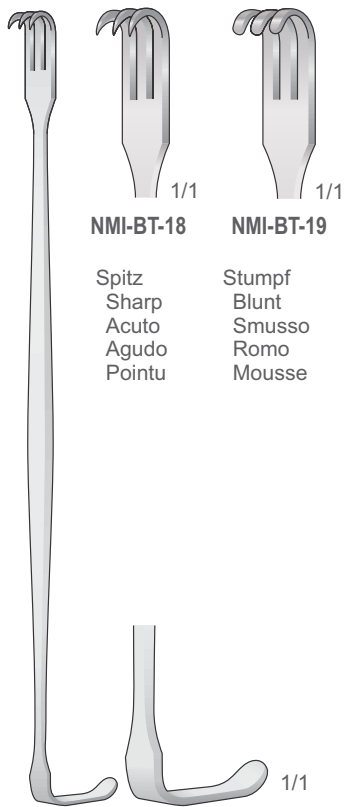
**NMI-BT-70**  
10 mm

**NMI-BT-72**  
14 mm

**NMI-BT-74**  
15 mm

**NMI-BT-77**  
17 mm

**DESMARRES**  
**NMI-BT-70/NMI-BT-77**  
140 mm



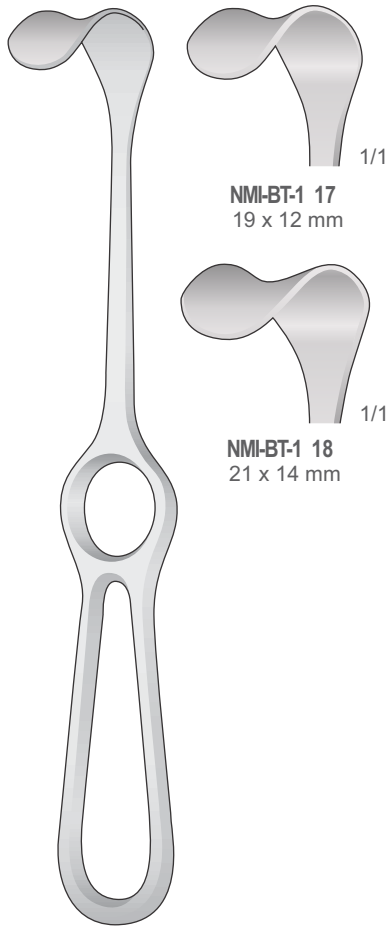
**NMI-BT-18**

**NMI-BT-19**

Spitz  
Sharp  
Acuto  
Agudo  
Pointu

Stumpf  
Blunt  
Smusso  
Romo  
Mousse

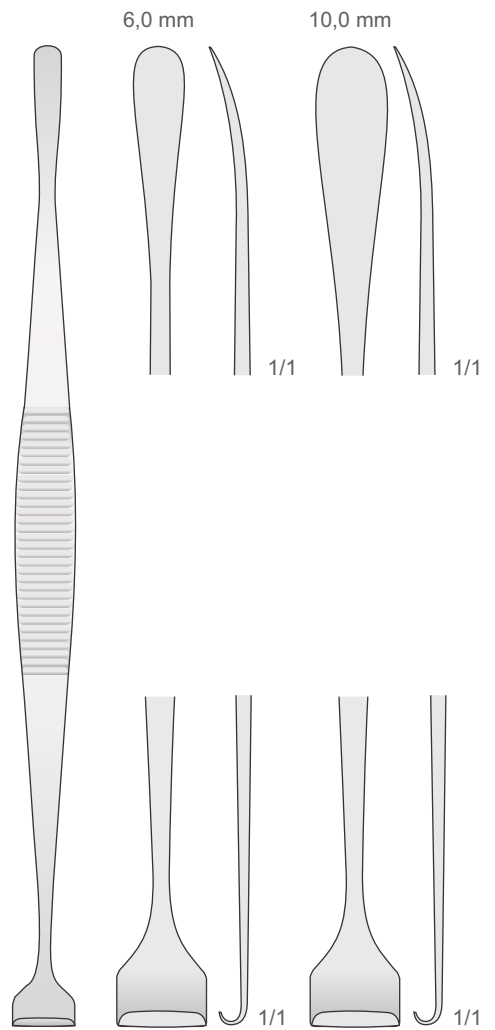
**SEAN-MILLER**  
**NMI-BT-18/NMI-BT-19**  
160 mm



**NMI-BT-17**  
19 x 12 mm

**NMI-BT-18**  
21 x 14 mm

**KOCHER**  
**NMI-BT-17/BT-18**  
205 mm



6,0 mm

10,0 mm

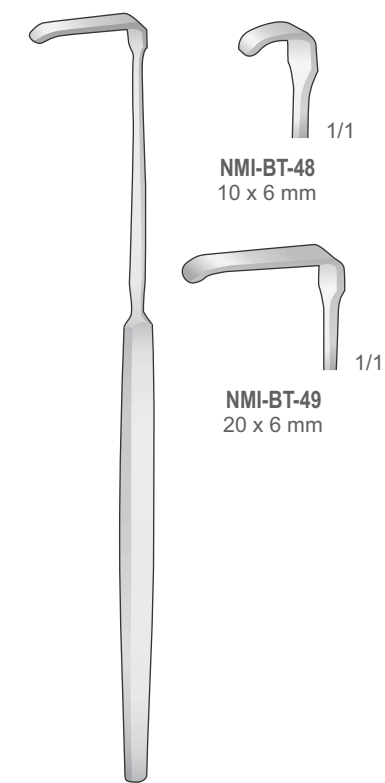
12 mm

12 mm

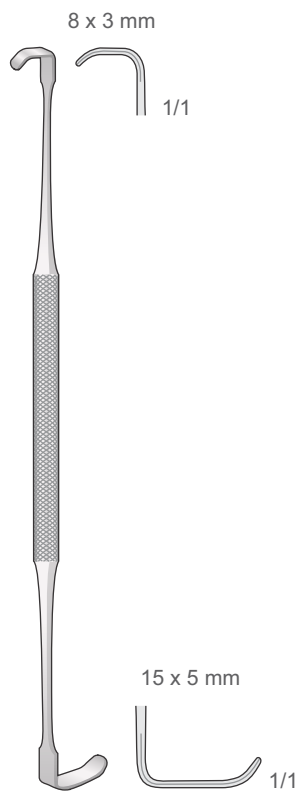
**HURD**  
**NMI-BT-1/NMI-BT-2**  
220 mm



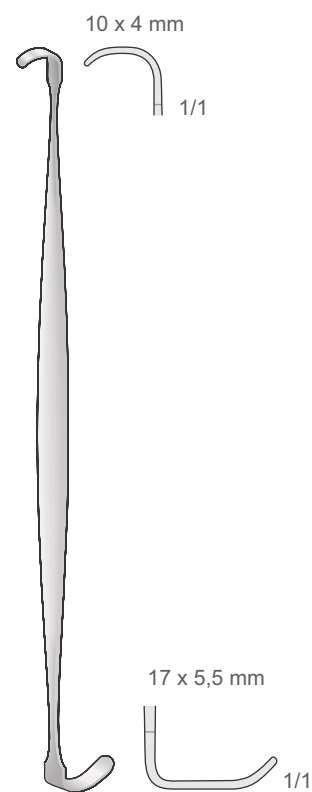
Wundhaken  
Retractors  
Divaricatori  
Separadores  
Écarteurs



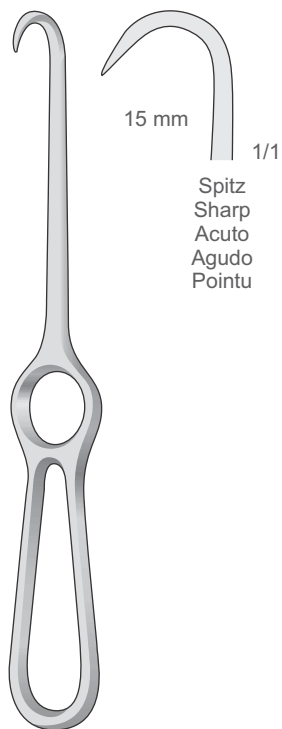
**SENN GREEN**  
**NMI-BT-48/NMI-BT-49**  
160 mm



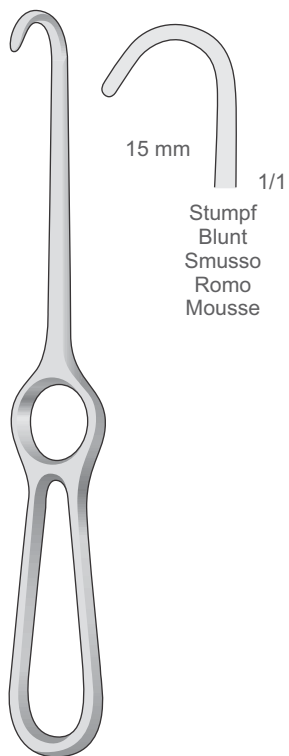
**RAGNELL**  
**NMI-BT-27**  
140 mm



**RAGNELL-DAVIS**  
**NMI-BT-26**  
140 mm



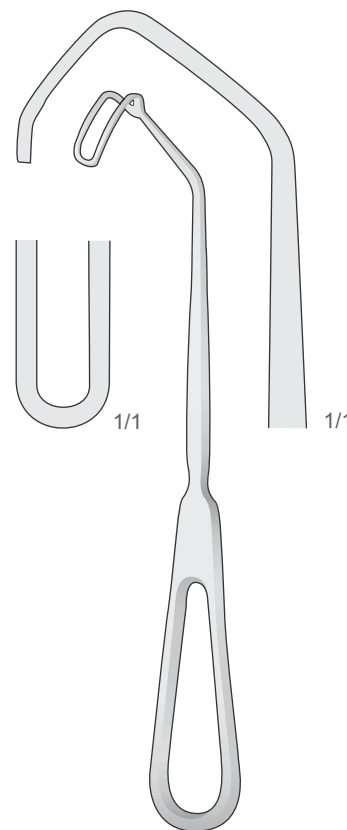
**KOCHER**  
**NMI-BT-139**  
205 mm



**KOCHER**  
**NMI-BT-140**  
220 mm

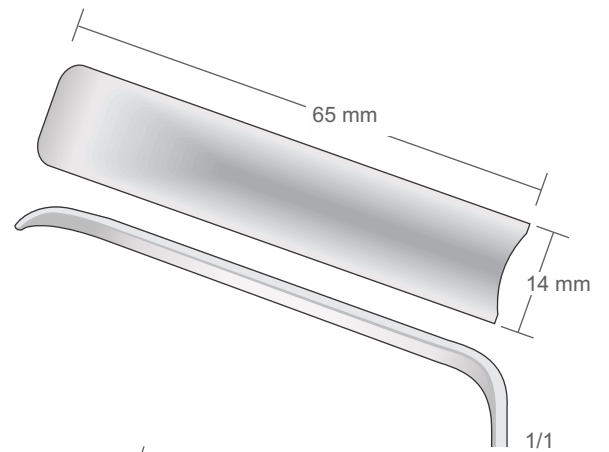


**LAHEY**  
**NMI-BT-109**  
195 mm

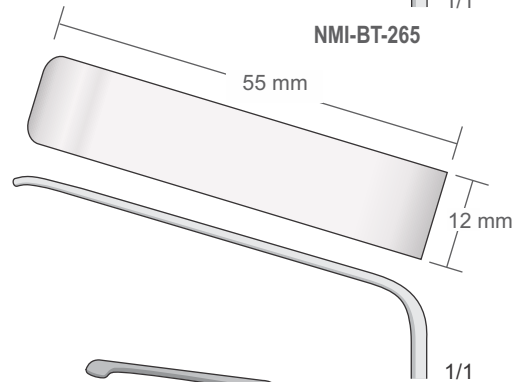


**CUSHING**  
**NMI-BT-29**  
200 mm

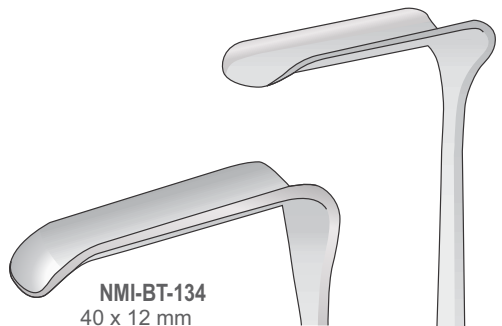
Wundhaken  
Retractors  
Divaricatori  
Separadores  
Écarteurs



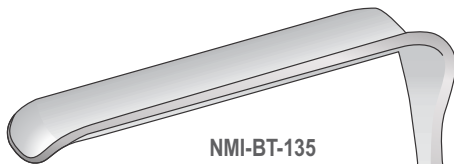
**NMI-BT-265**



**NMI-BT-264**



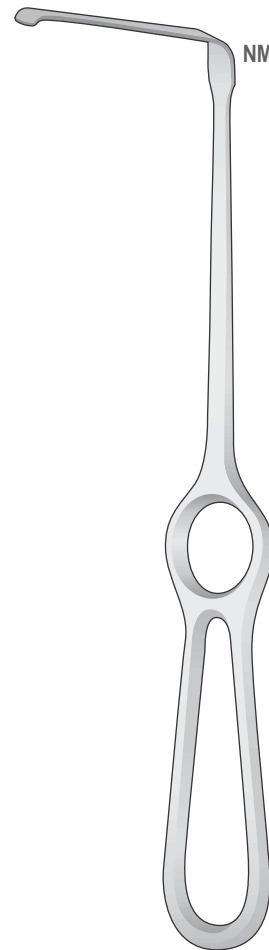
**NMI-BT-134**  
40 x 12 mm



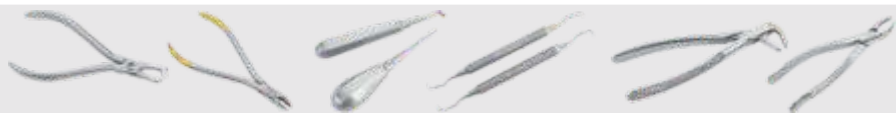
**NMI-BT-135**  
55 x 14 mm



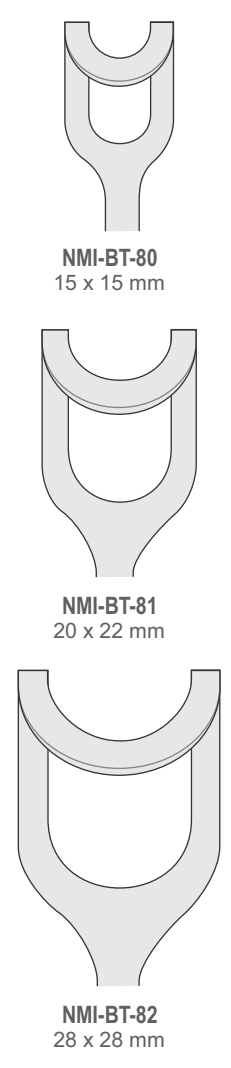
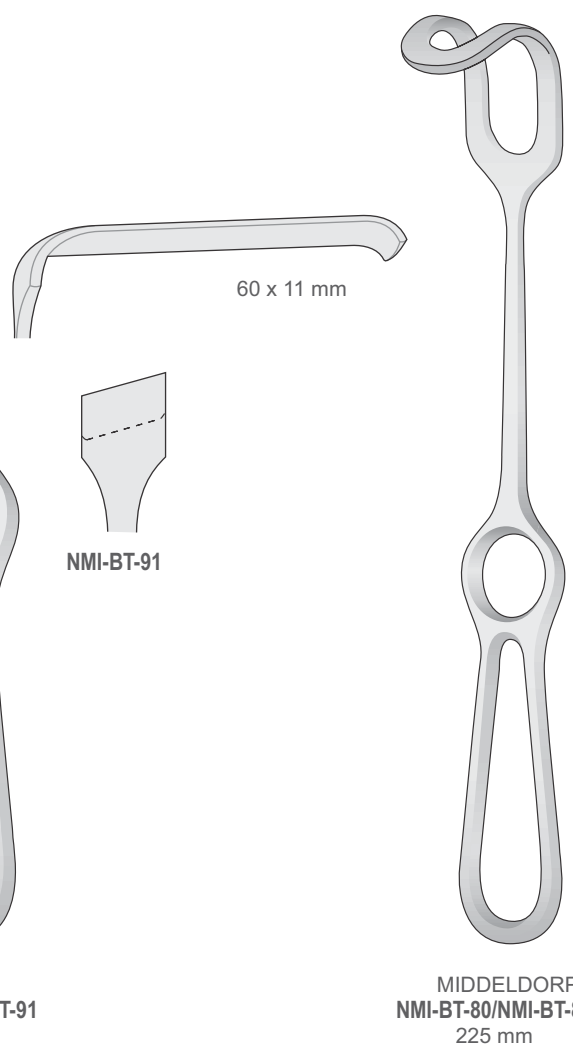
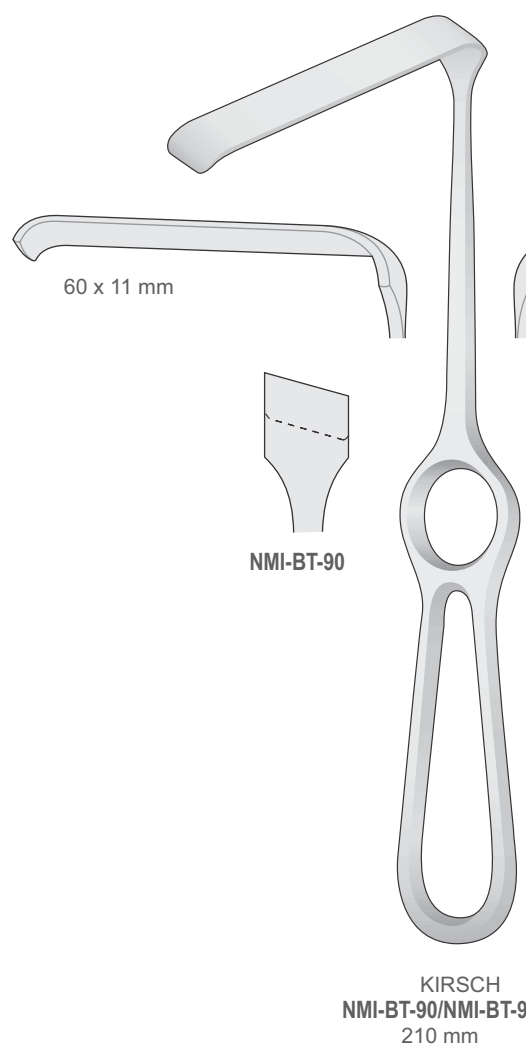
**DOCKHORN**  
**NMI-BT-134/NMI-BT-135**  
210 mm



**NMI-BT-264/NMI-BT-265**  
235 mm



Wundhaken  
Retractors  
Divaricatori  
Separadores  
Écarteurs

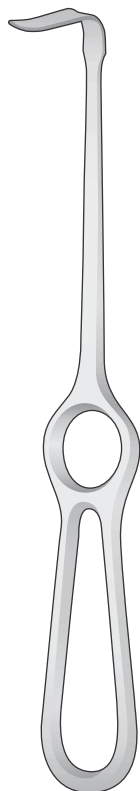




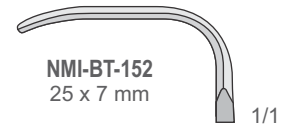
Wundhaken  
Retractors  
Divaricatori  
Separadores  
Écarteurs



OBWEGESER  
NMI-BT-152/NMI-BT-157  
220 mm



OBWEGESER  
NMI-BT-92/NMI-BT-100  
220 mm



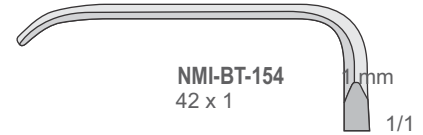
NMI-BT-152  
25 x 7 mm

1/1



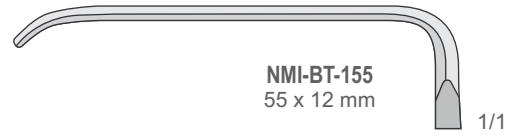
NMI-BT-153  
31 x 10 mm

1/1



NMI-BT-154  
42 x 1

1/1



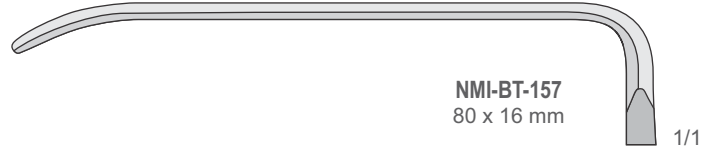
NMI-BT-155  
55 x 12 mm

1/1



NMI-BT-156  
70 x 14 mm

1/1



NMI-BT-157  
80 x 16 mm

1/1



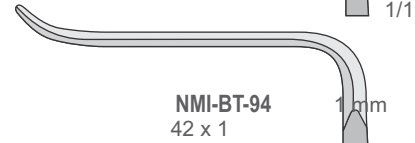
NMI-BT-92  
25 x 7 mm

1/1



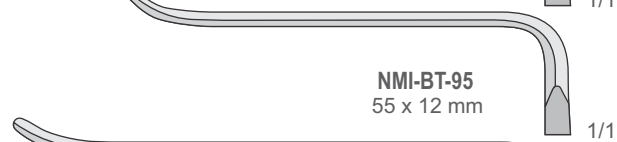
NMI-BT-93  
31 x 10 mm

1/1



NMI-BT-94  
42 x 1

1/1



NMI-BT-95  
55 x 12 mm

1/1



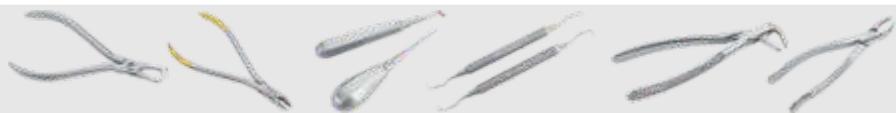
NMI-BT-96  
70 x 14 mm

1/1

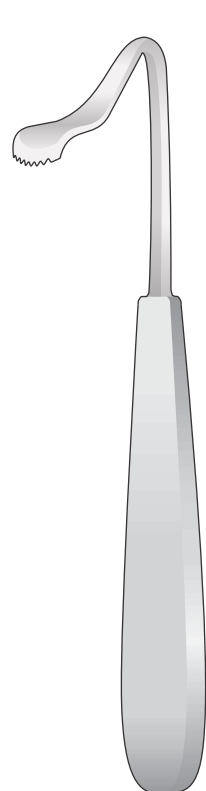


NMI-BT-100  
80 x 16 mm

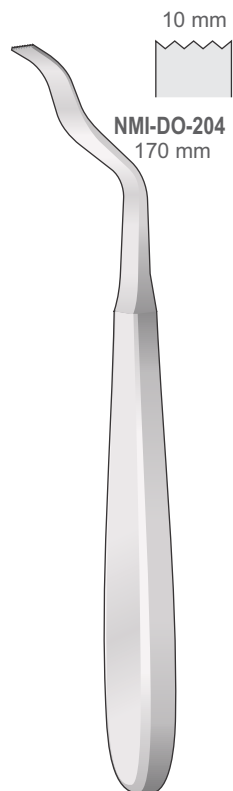
1/1



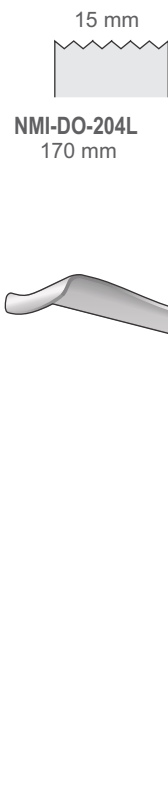
Wundhaken  
Retractors  
Divaricatori  
Separadores  
Écarteurs



**BOWLED-HENRY**  
**NMI-DO-175**  
170 mm



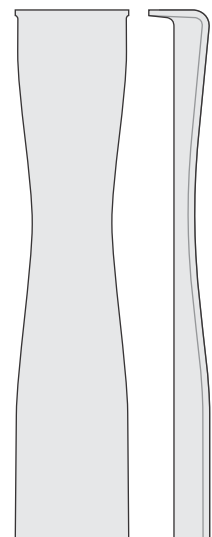
**NMI-DO-204**  
170 mm



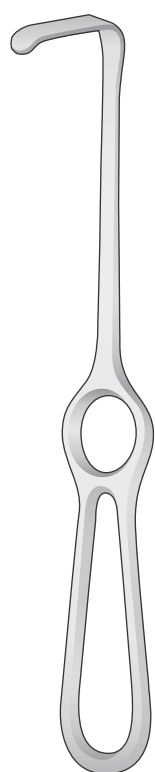
**NMI-DO-204L**  
170 mm



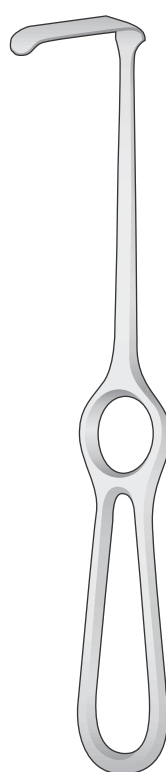
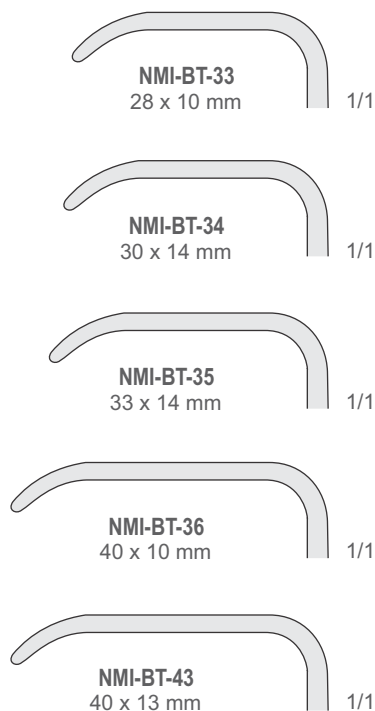
**AUSTIN**  
**NMI-DO-212**  
140 mm



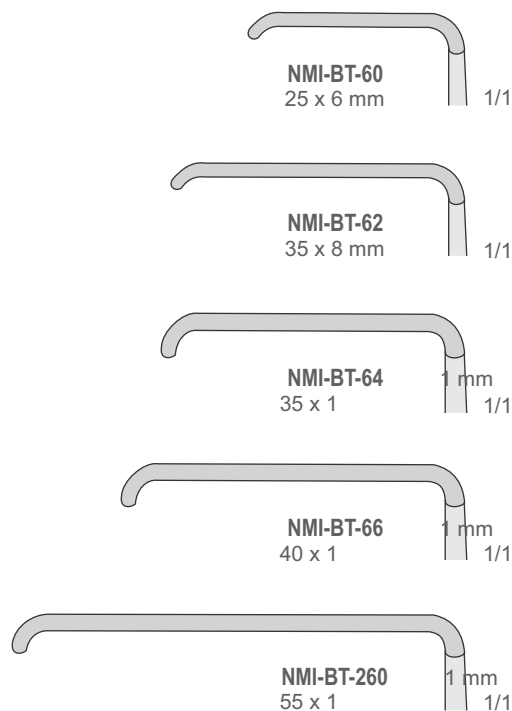
1/1



**LANGENBECK**  
**NMI-BT-33/NMI-BT-43**  
210 mm



**KOCHER-LANGENBECK**  
**NMI-BT-60/NMI-BT-260**  
215 mm



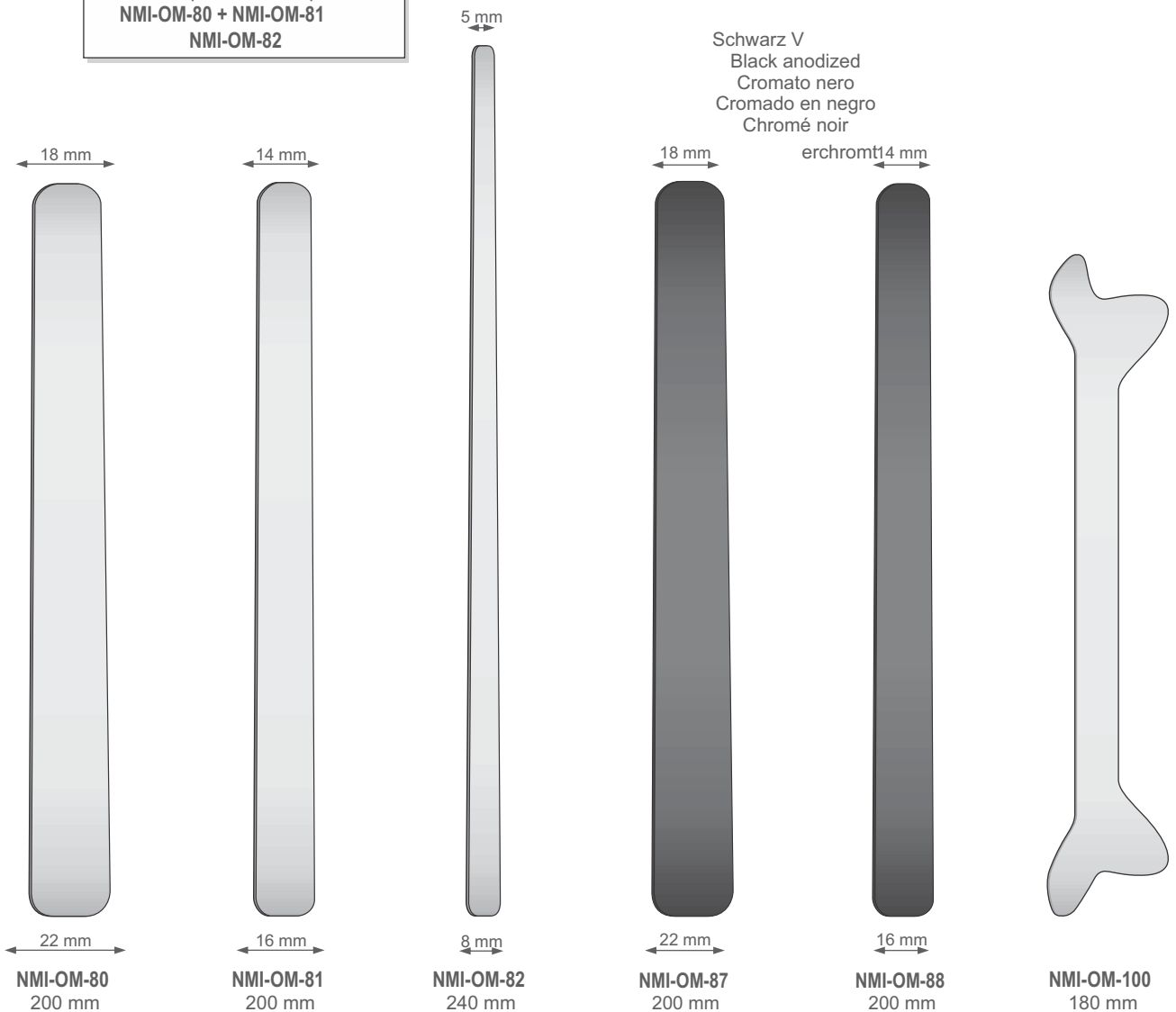


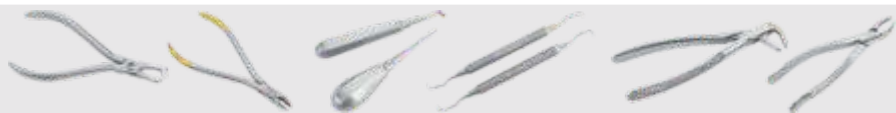
Wundhaken  
Retractors  
Divaricatori  
Separadores  
Écarteurs

Rostfrei - Stainless Steel  
Acciaio - Acero - Acer

Biegsam - Malleable  
Malleabili - Maleables  
Souples

**NMI-OM-85**  
Komplettset mit 3 Spatel  
Set complete with 3 spatulas  
Set completo con 3 spatole  
Set completos con 3 espátulas  
Set complete avec 3 spatules  
**NMI-OM-80 + NMI-OM-81**  
**NMI-OM-82**

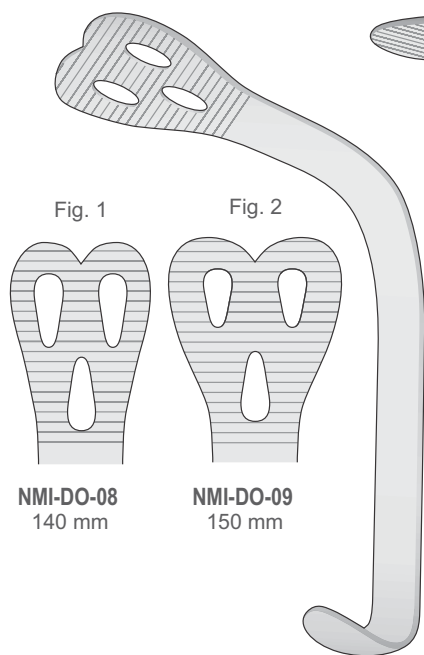
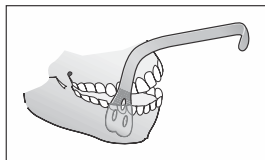




Wundhaken  
Retractors  
Divaricatori  
Separadores  
Écarteurs

Zungendrucker  
Tongue Depressors  
Abbassalingua  
Bajalengua  
Abaisse langue

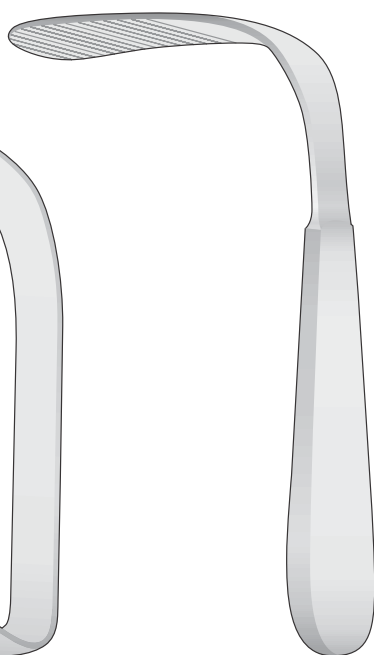
Kinnhalter  
Chin Holder  
Divaricatore per mento  
Separador para mentón  
Écarteur pour menton



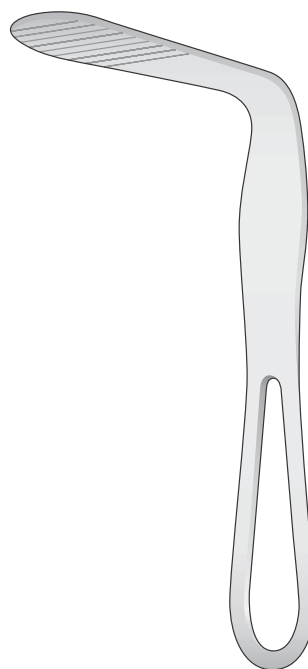
**NMI-DO-08**  
140 mm

**NMI-DO-09**  
150 mm

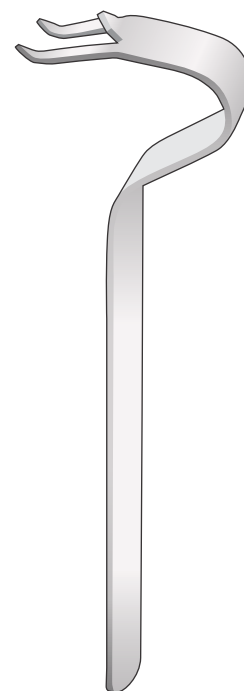
**WIEDER**  
**NMI-DO-08/NMI-DO-09**



**TOBOLD**  
**NMI-OM-08**  
145 mm



**HARTMANN**  
**NMI-OM-06**  
150 mm

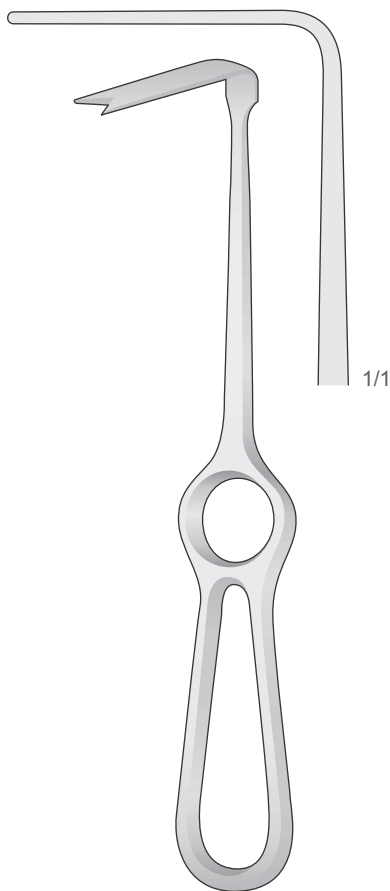


**OBWEGESER**  
**NMI-DO-40**  
155 mm

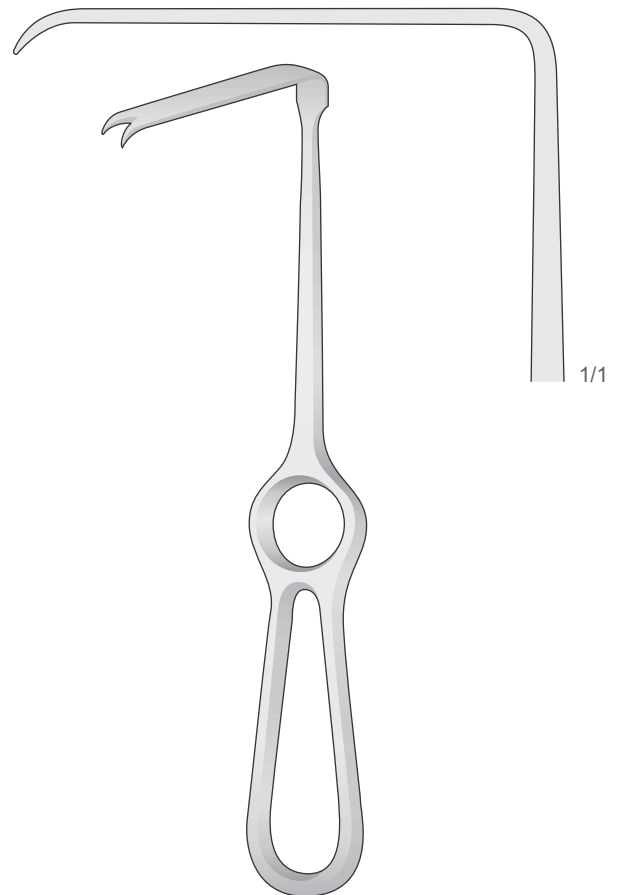
Wundhaken  
Retractors  
Divaricatori  
Separadores  
Écarteurs



Ramushaken für Spina Nasalis  
Ramus Retractor for nasal spine  
Divaricatori per spina nasalis  
Separadores para spina nasalis  
Écarteurs pour spina nasalis



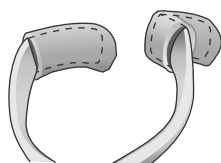
OBWEGESER  
NMI-BT-67  
220 mm



OBWEGESER  
NMI-BT-68  
220 mm



Mundsperrer  
Mouth gags  
Apribocca  
Abrebocas  
Écarteur buccal



Paar Einsätzen aus Silikon für:  
Pair of silicone inserts for:  
Coppia di inserti in silicone per:  
Pareja de inserto de silicone para:  
Paire de inserts en silicon pour:

**NMI-OM-40 - NMI-OM-41**

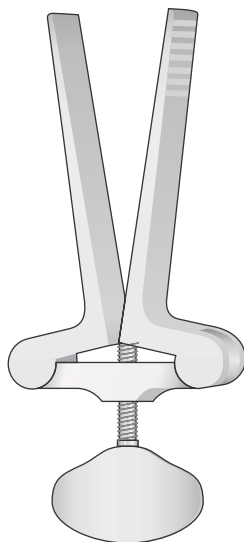
Ø 8 mm

Ø 11 mm

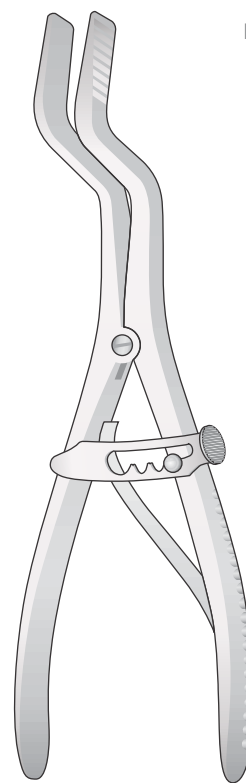


**NMI-OM-40R**  
30 mm

**NMI-OM-41R**  
30 mm

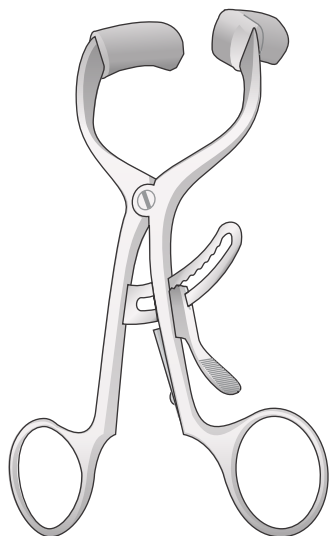


**HEISTER**  
**NMI-OM-62**  
135 mm



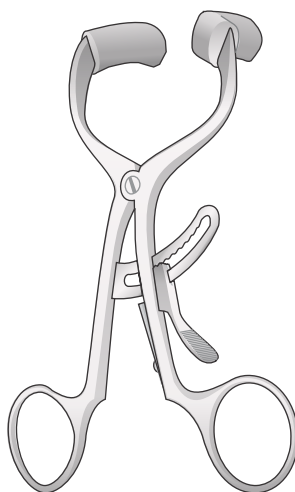
**ROSER KÖNIG**  
**NMI-OM-60**  
185 mm

Für Erwachsene - For adults  
Per adulti - Para adultos  
Pour adultes



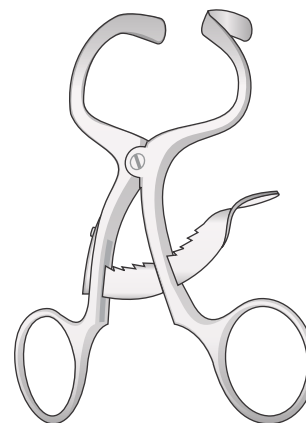
**MOLT**  
**DOYEN-JANSEN**  
**NMI-OM-41**  
140 mm

Für Erwachsene - For adults  
Per adulti - Para adultos  
Pour adultes



**MOLT**  
**DOYEN-COLLIN**  
**NMI-OM-40**  
120 mm

Für Kinder  
For children  
Per bambini  
Para niños  
Pour enfants



**MOLT**  
**NMI-OM-42**  
100 mm



Mundsperrer  
Mouth gags  
Apribocca  
Abrebocas  
Écarteur buccal

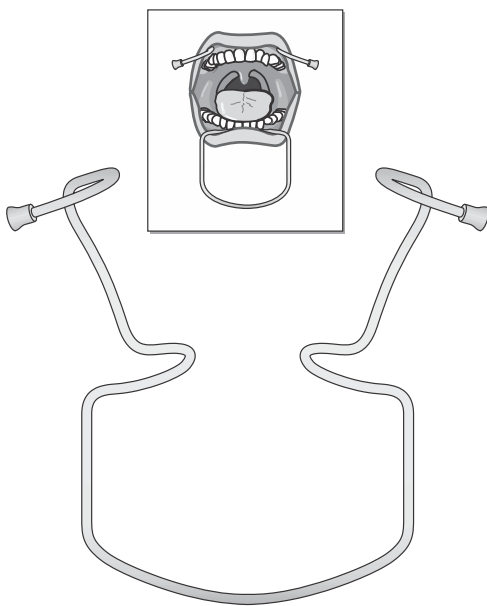
Abhalter für gesamten Ober-bzw. Unterkiefer  
Retractor for complete upper resp. Lower jaws  
Retratore per arcata superiore e inferiore intera  
Separadores para quijadas enteras inferiores y superiores  
Écarteurs pour machoires complètes inférieures et supérieures

**NMI-OM-74** Fig. 0 100 x 95 mm  
**NMI-OM-75** Fig. 1

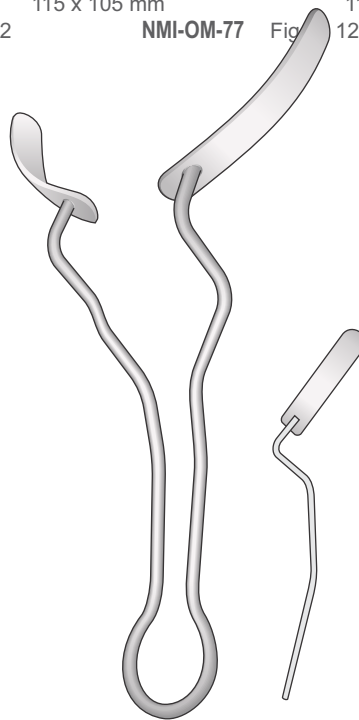
**NMI-OM-76** Fig. 2 115 x 105 mm

**NMI-OM-77** Fig. 115 x 110 mm  
125 x

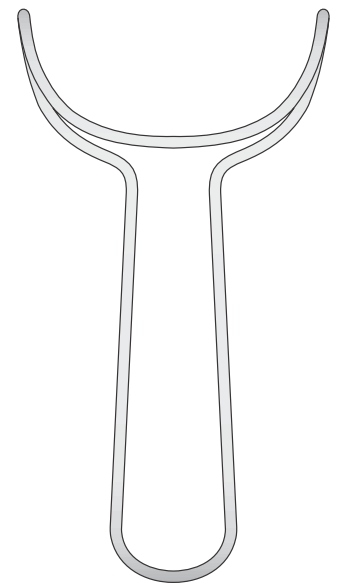
115 mm



ORINGER  
NMI-OM-74/NMI-OM-77



MATY  
NMI-OM-97  
170 mm



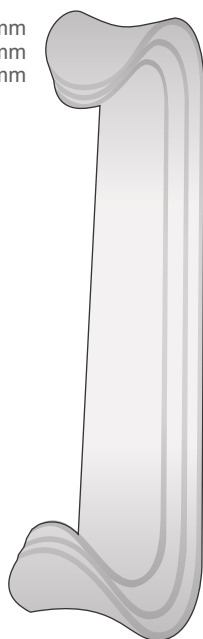
NMI-OM-90  
150 mm



**NMI-BT-283**  
Set completo  
Set complete  
Komplettsset  
Set complet  
Set completo  
**NMI-BT-284 + NMI-BT-285**  
**NMI-BT-286**

29 mm  
26 mm  
22 mm

28 mm  
38 mm  
44 mm

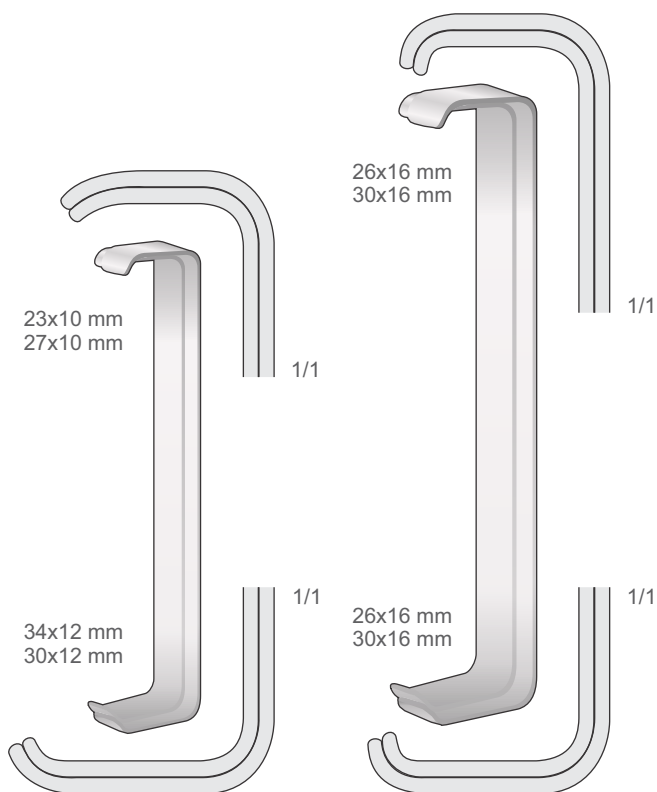


**ROUX**  
**NMI-BT-283**  
165 mm

**ROUX**  
**NMI-BT-284**  
20x22 mm  
25x28 mm

**ROUX**  
**NMI-BT-285**  
23x26 mm  
29x38 mm

**ROUX**  
**NMI-BT-286**  
29x29 mm  
34x44 mm



23x10 mm  
27x10 mm

26x16 mm  
30x16 mm

20x22 mm

23x26 mm

29x29 mm

34x12 mm  
30x12 mm

26x16 mm  
30x16 mm

25x28 mm

29x38 mm

34x44 mm

**FARABEUFF**  
**NMI-BT-20**  
120 mm

**FARABEUFF**  
**NMI-BT-25**  
150 mm

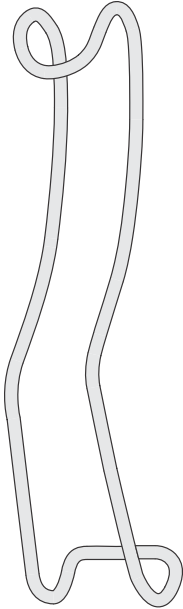
**ROUX-MAGNUS**  
**NMI-BT-287**  
150 mm

**ROUX-MAGNUS**  
**NMI-BT-288**  
160 mm

**ROUX-MAGNUS**  
**NMI-BT-289**  
170 mm



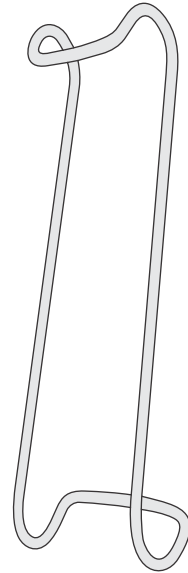
Wangenhalter  
Cheek Retractors  
Divaricatori per guance  
Separador para mejillas  
Écarteurs des joues



STERNBERG  
NMI-OM-50  
160 mm

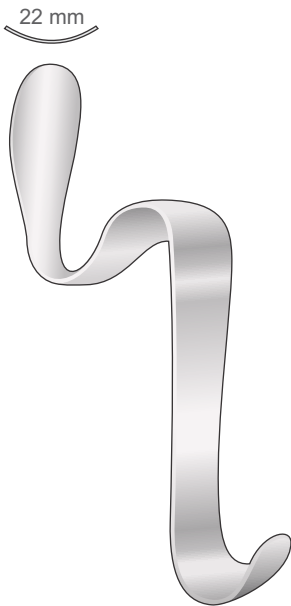


STERNBERG  
NMI-OM-52  
160 mm



COLUMBIA  
NMI-OM-67  
140 mm

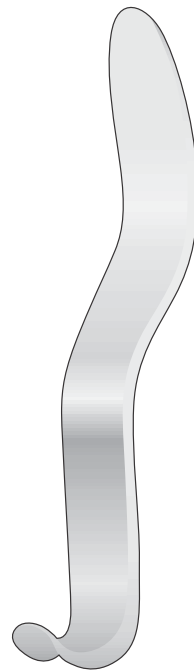
Schwarz Verchromt  
Black anodized  
Cromato nero  
Cromado en negro  
Chromé noir



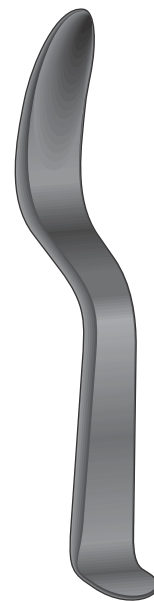
BISHOP  
NMI-OM-61  
130 mm



MINNESOTA  
NMI-OM-55  
140 mm

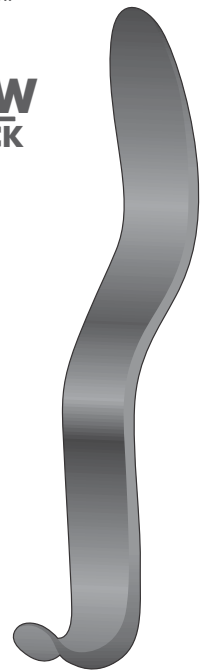


CAWOOD-MINNESOTA  
NMI-OM-66  
160 mm



MINNESOTA  
NMI-OM-55B  
140 mm

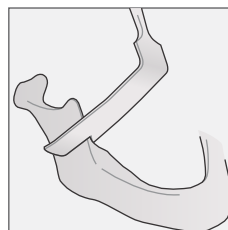
**NEW  
BLACK**



CAWOOD-MINNESOTA  
NMI-OM-66B  
160 mm



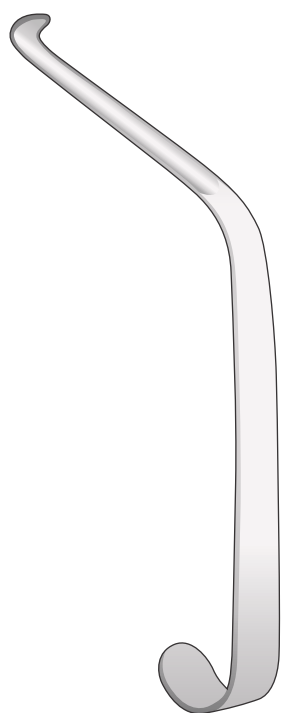
Wundhaken  
Retractors  
Divaricatori  
Separadores  
Écarteurs



Ramus Retraktoren Recht  
Ramus Retractor Right  
Retrattore Ramus destro  
Separadores Ramus derecho  
Écarteur Ramus droites

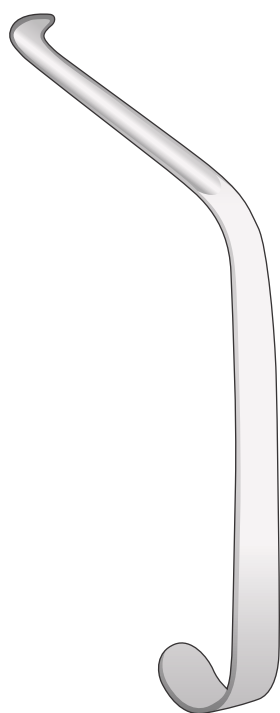
Ramus Retraktoren Link  
Ramus Retractor Left  
Retrattore Ramus sinistro  
Separadores Ramus izquierdo  
Écarteur Ramus gauches

8 mm

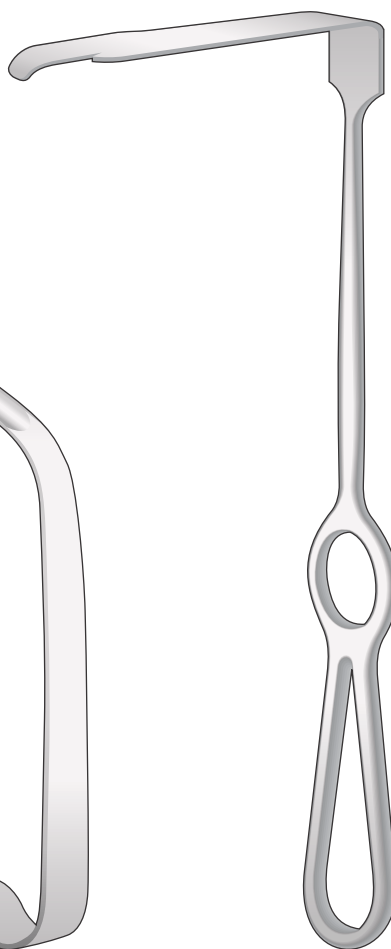


OBWEGESER  
**NMI-DO-41**  
165 mm

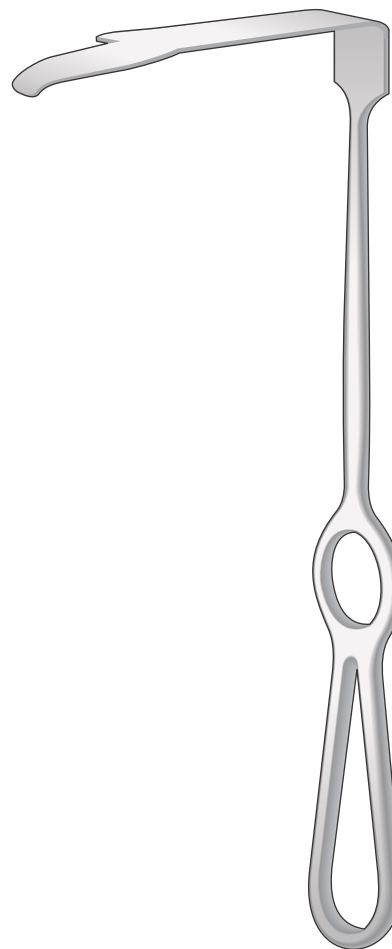
10 mm



OBWEGESER  
**NMI-DO-142**  
165 mm



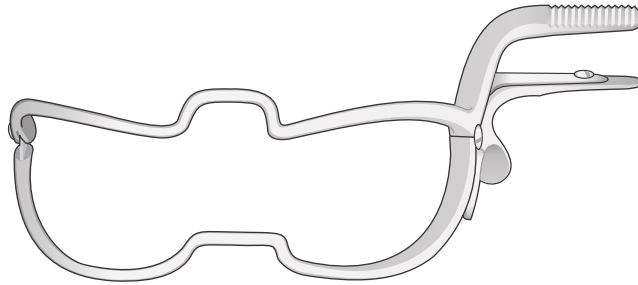
MISCH  
**NMI-BT-158**  
210 mm



MISCH  
**NMI-BT-159**  
210 mm

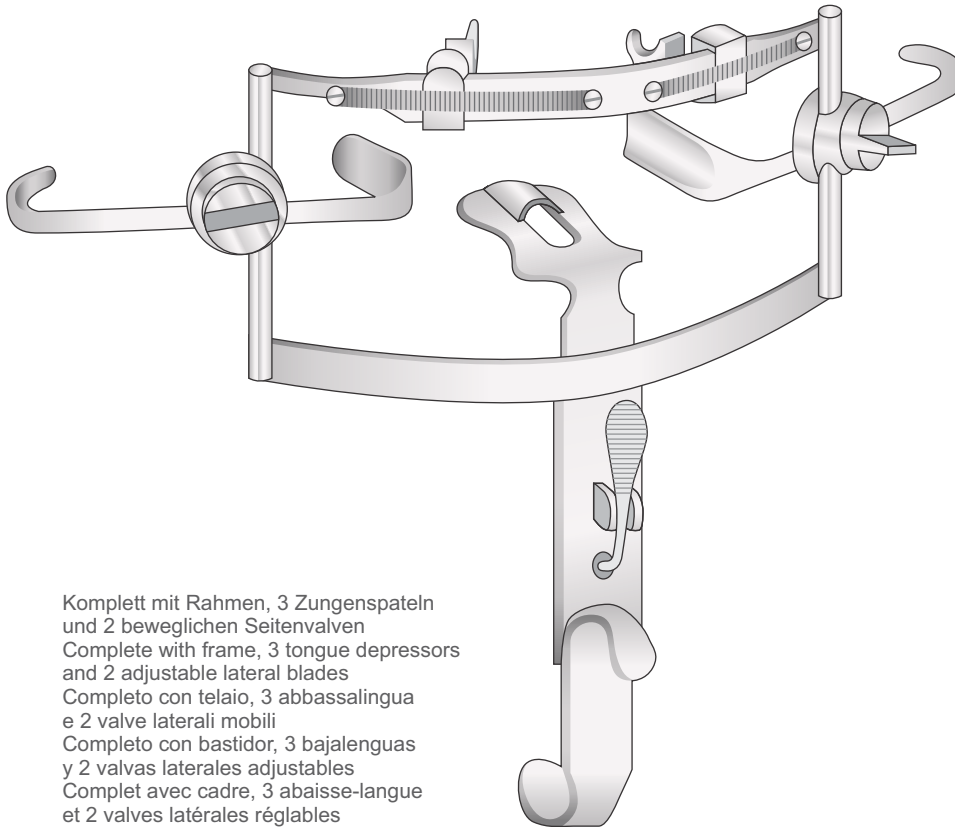


Mundsperrer  
Mouth Gags  
Apribocca  
Abrebocas  
Écarteur buccal



**WHITEHEAD-JENNINGS**

<b>NMI-OM-136</b>	90 mm	10 mm
<b>NMI-OM-137</b>	1	
<b>NMI-OM-138</b>	130 mm	
<b>NMI-OM-139</b>	150 mm	



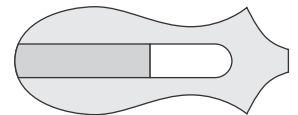
Komplett mit Rahmen, 3 Zungenspateln  
und 2 beweglichen Seitenvälven  
Complete with frame, 3 tongue depressors  
and 2 adjustable lateral blades  
Completo con telaio, 3 abbassalingua  
e 2 valve laterali mobili  
Completo con bastidor, 3 bajalenguas  
y 2 valvas laterales ajustables  
Complet avec cadre, 3 abaisse-langue  
et 2 valves latérales réglables

**DINGMANN**  
**NMI-OM-1 10**  
Set completo

**DINGMANN**

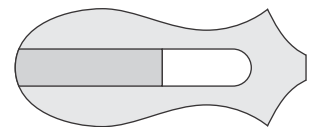
Zungenspatel  
Tongue depressor  
Abbassalingua  
Bajalengua  
Abaisse langue

Fig. 1



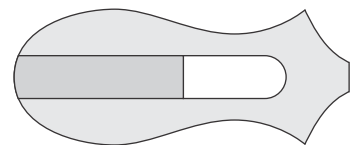
**NMI-OM-1 12**  
65 x 25 mm

Fig. 2

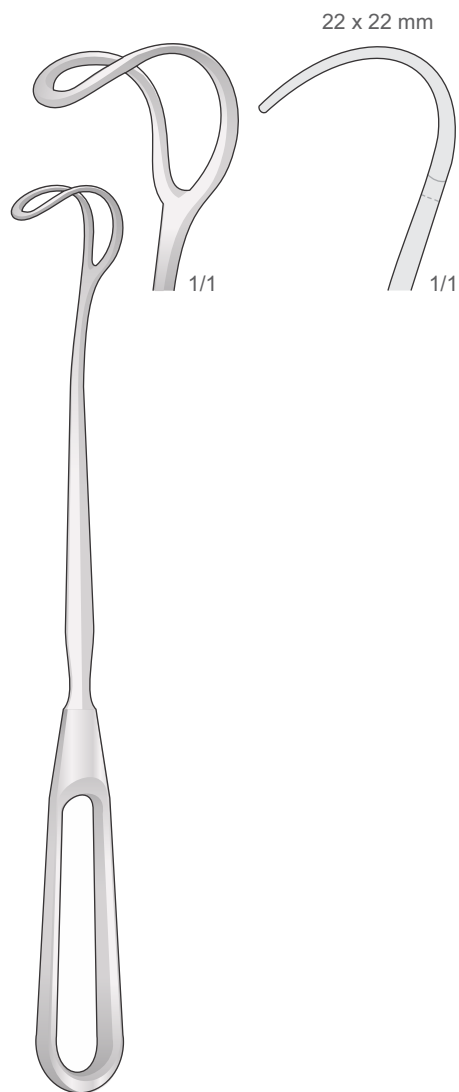


**NMI-OM-1 13**  
70 x 29 mm

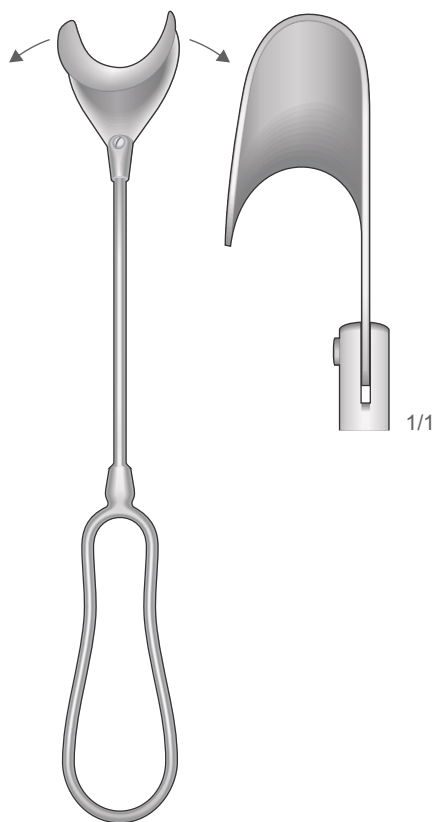
Fig. 3



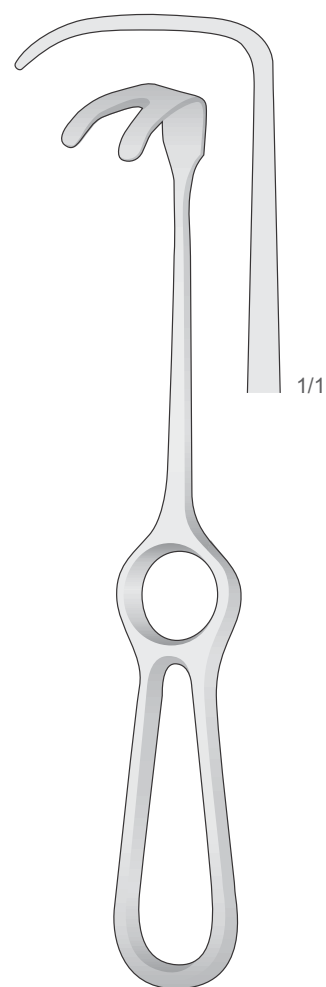
**NMI-OM-1 14**  
80 x 32 mm



**GREENE**  
**NMI-BT-131**  
225 mm



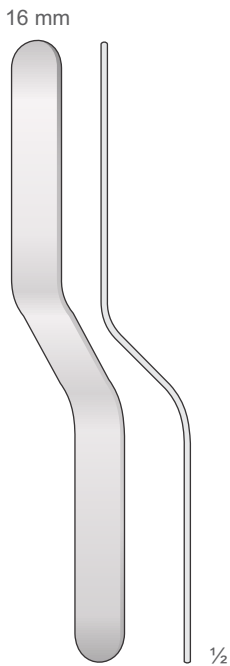
**NMI-BT-132**  
200 mm



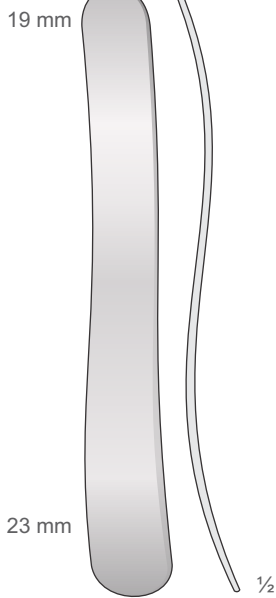
**WASSMUND**  
**NMI-BT-69**  
220 mm



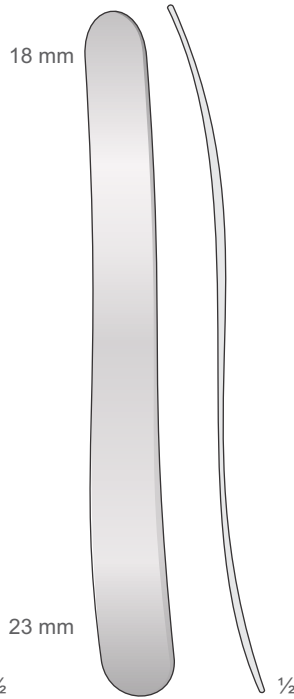
Zungenspatel - Zungenzangen  
Tongue Depressors - Tongue Holding Forceps  
Abbassalingua - Pinze tiralingua  
Bajalenguas - Pinzas tira-lengua  
Abaisse langues - Pincés tire-langue



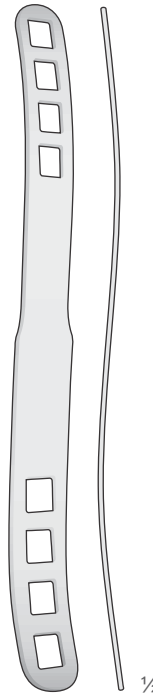
**NMI-OM-07**  
145 mm



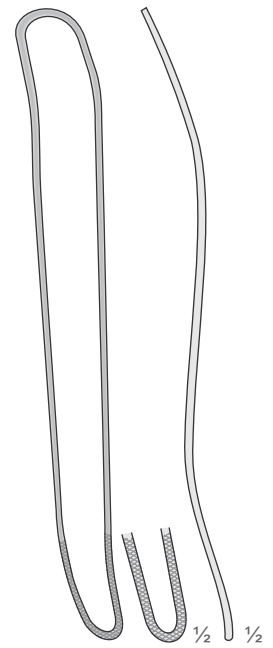
**KROENIG  
NMI-OM-16**  
150 mm



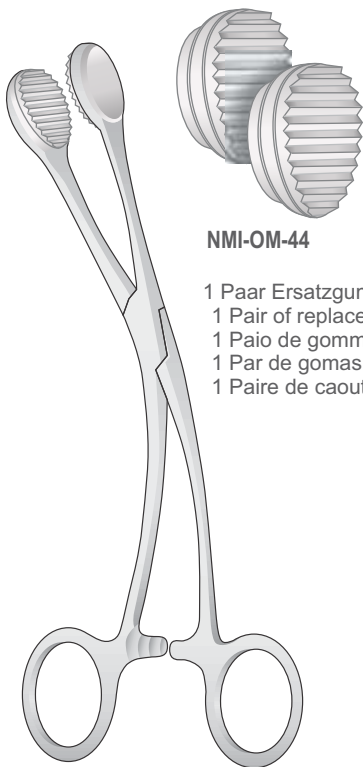
**BUCHWALD  
NMI-OM-18**  
180 mm



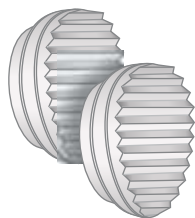
**BRUENINGS  
NMI-OM-04**  
190 mm



**FRENZEL  
NMI-OM-19**  
165 mm

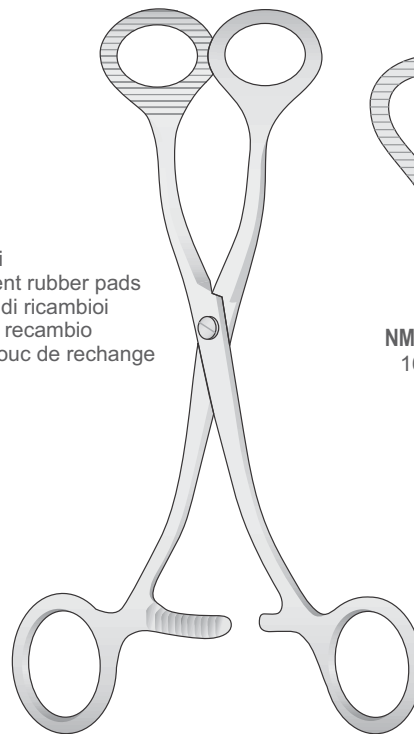


**YOUNG  
NMI-OM-45**  
160 mm

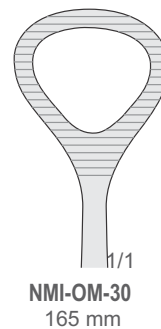


**NMI-OM-44**

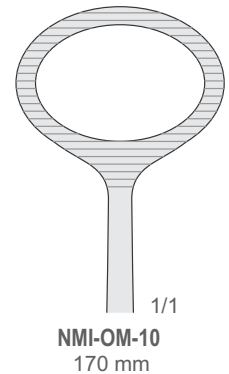
- 1 Paar Ersatzgummi
- 1 Pair of replacement rubber pads
- 1 Paio de gommini di ricambio
- 1 Par de gomas de recambio
- 1 Paire de caoutchouc de rechange



**COLLIN  
NMI-OM-10/NMI-OM-30**



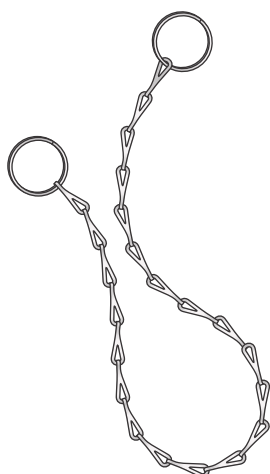
**NMI-OM-30**  
165 mm



**NMI-OM-10**  
170 mm



Kette und Mundstutzen  
Chain and Mouth Props  
Catene e Apribocca  
Cadena y Abrebocas  
Chaîne et Ouvre Bouche



**NMI-KE-20**  
200 mm



**NMI-KE-40**  
400 mm

Dampfsterilisation bis 134°C  
Autoclavable to 134°C  
Autoclavabile a 134°C  
Autoclave hasta 134°C  
Autoclavable jusqu'à 134°C

Packung mit 2 Stück  
Package with 2 units  
Confezione da 2 pezzi  
Caja con 2 unidades  
Boîte avec 2 pièces

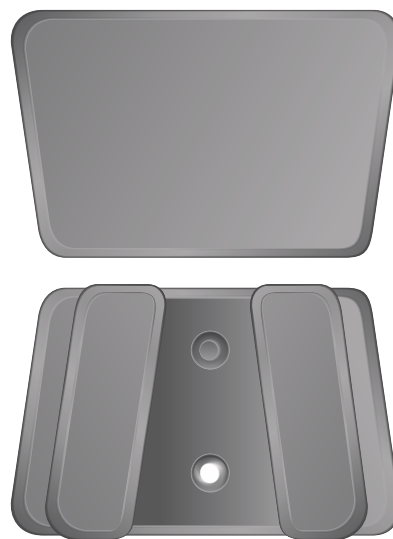
Schwarzer Gummi  
Black Rubber  
Gomma nera  
Caucho negro  
Caoutchouc noir



**NMI-OM-70**  
SMALL  
Klein, für Kinder  
Small, for children  
Piccolo, per bambini  
Pequeño, para niños  
Petit, pour enfants



**NMI-OM-71**  
MEDIUM  
Normal, für Erwachsene  
Regular, for adults  
Normale, per adulti  
Regular, para adultos  
Regulier, pour adultes



**NMI-OM-72**  
LARGE  
Groß, für Erwachsene  
Large, for adults  
Grande, per adulti  
Grande, para adultos  
Grand, pour adultes

# DENTAL Instruments

Extracting Forceps

Root Elevators

Scalpel Blades and Handles

Surgical Scissors

Tissue and Dressing Forceps

Needle Holders

Hemostatic Forceps | Towel Clamps

Retractors | Mouth Gags

**Implantology**

Periosteal | Curettes | Rongeurs

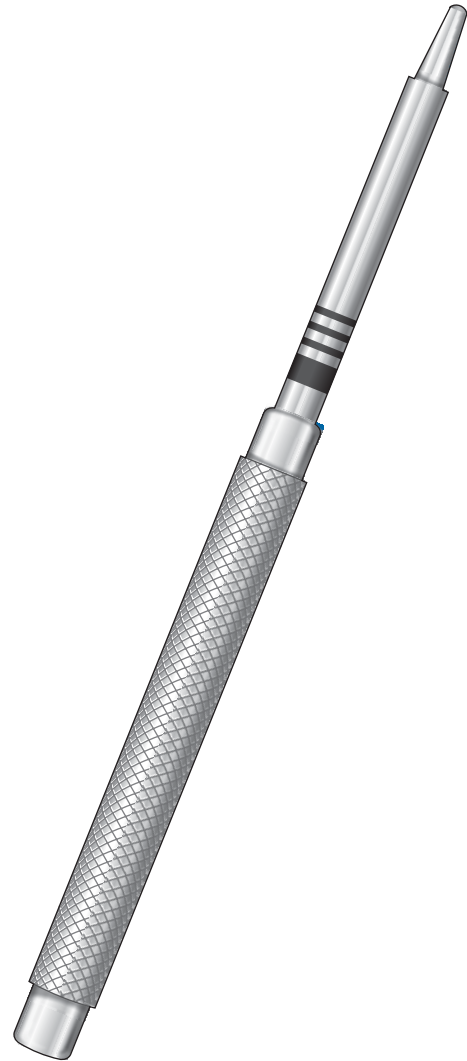
Dental Restoration | Periodontology

**Suction Tube**

Orthodontics

Crown Instruments | Laboratory

Instrument Maintenance | Sterilization



191-213

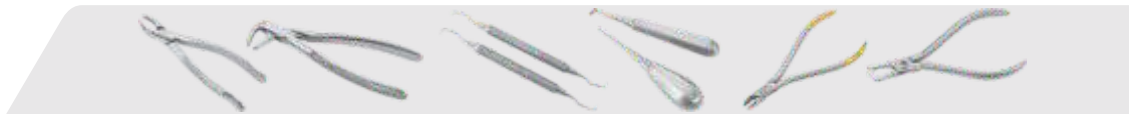
**Implantology**

Implantologie

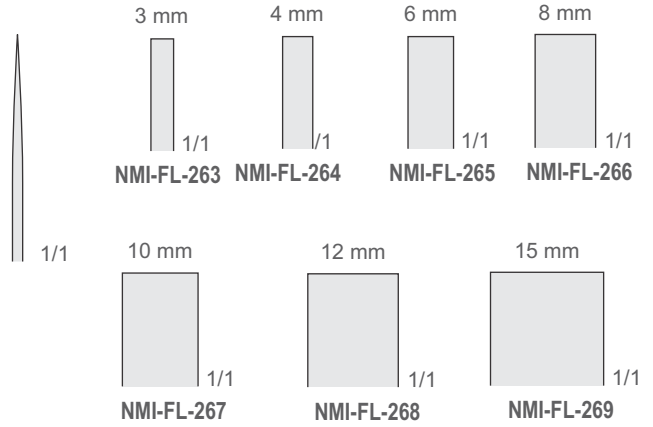
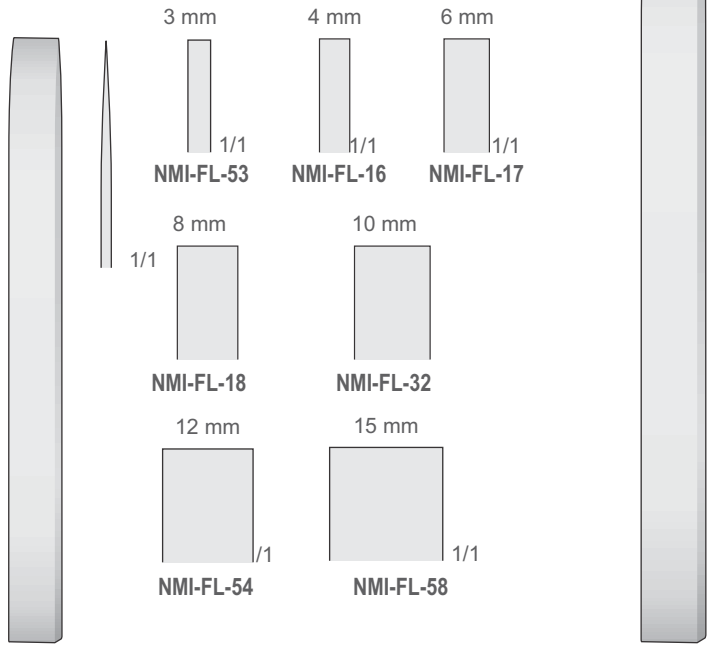
Implantologie

Implantología

Implantologia

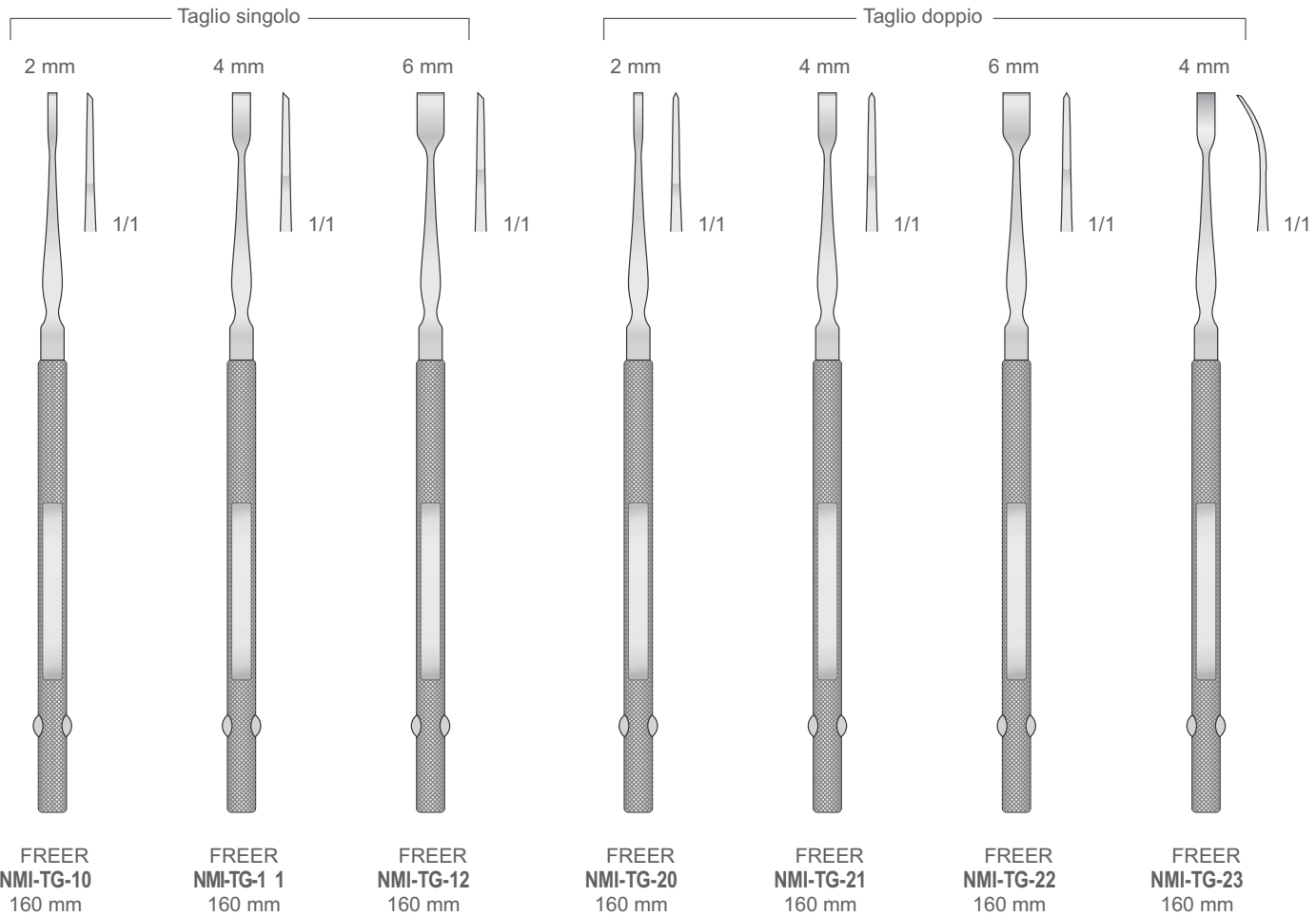


Osteotome  
Osteotomes  
Osteotomi  
Osteótomos  
Ostéotomes



MINI-LAMBOTTE  
NMI-FL-16/NMI-FL-58  
125 mm

MINI-LAMBOTTE  
NMI-FL-263/NMI-FL-269  
170 mm



FREER  
NMI-TG-10  
160 mm

FREER  
NMI-TG-11  
160 mm

FREER  
NMI-TG-12  
160 mm

FREER  
NMI-TG-20  
160 mm

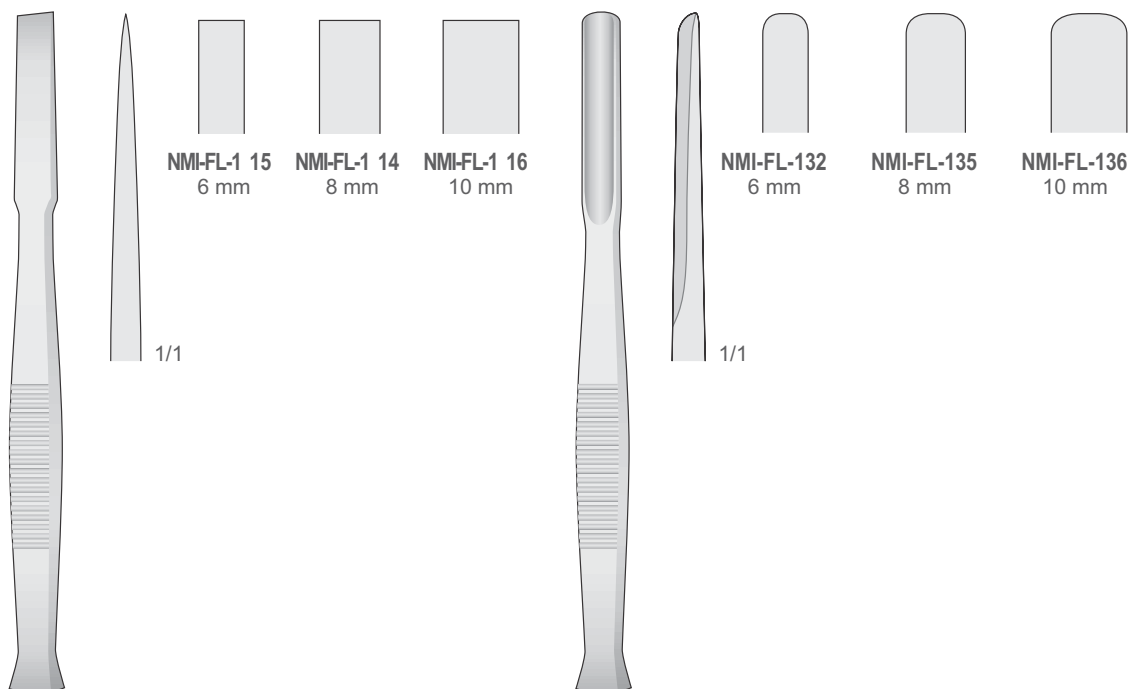
FREER  
NMI-TG-21  
160 mm

FREER  
NMI-TG-22  
160 mm

FREER  
NMI-TG-23  
160 mm



Osteotome - Meißel  
Osteotomes - Gouges  
Osteotomi - Sgorbie  
Osteótomos - Gubias  
Ostéotomes - Gouges

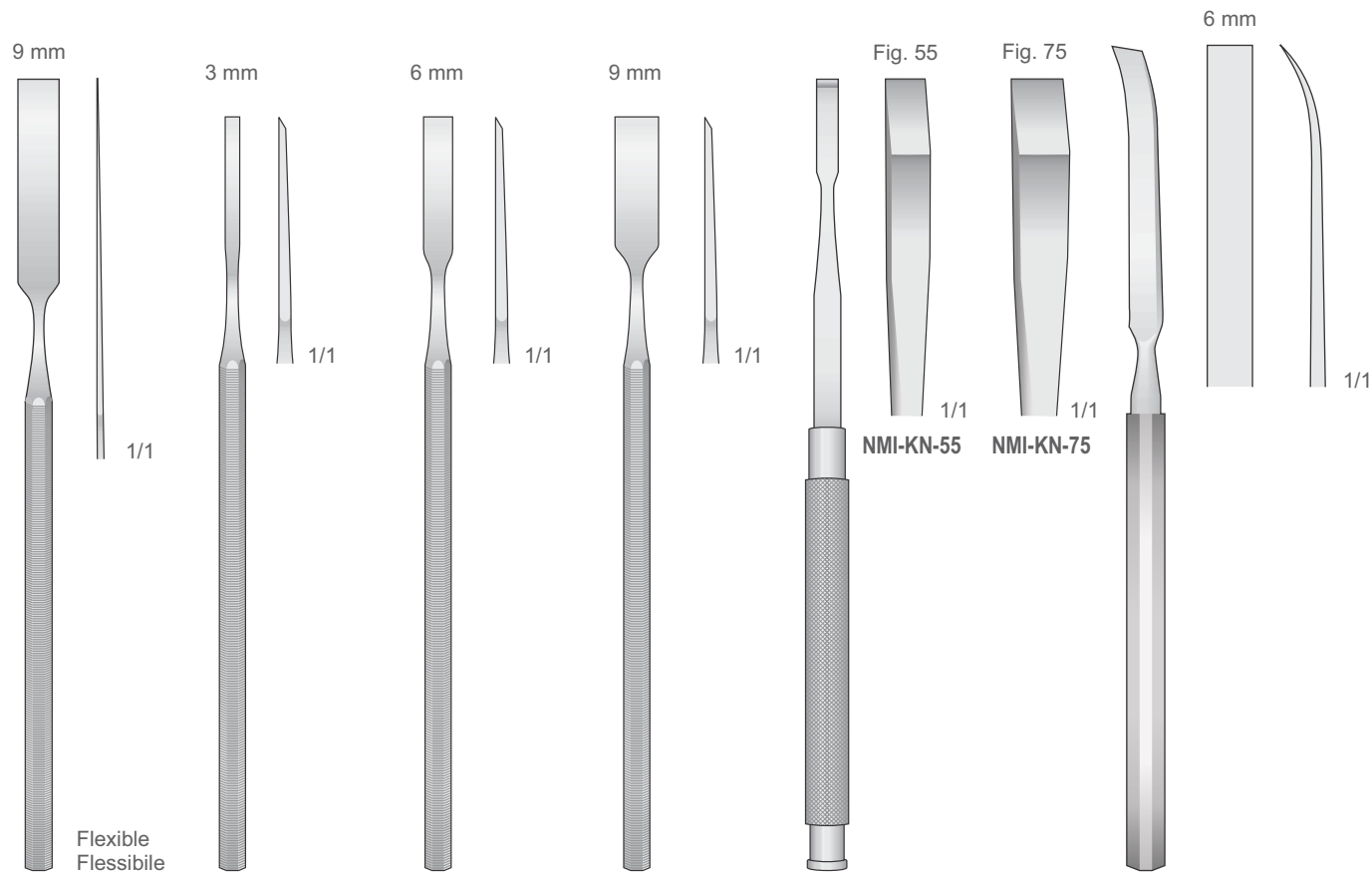


NMI-FL-1 15 6 mm  
NMI-FL-1 14 8 mm  
NMI-FL-1 16 10 mm

NMI-FL-132 6 mm  
NMI-FL-135 8 mm  
NMI-FL-136 10 mm

NMI-FL-1 14/NMI-FL-1 16  
140 mm

NMI-FL-132/NMI-FL-136  
140 mm



Flexible  
Flessibile

NMI-TG-15  
170 mm

NMI-TG-30  
155 mm

NMI-TG-31  
155 mm

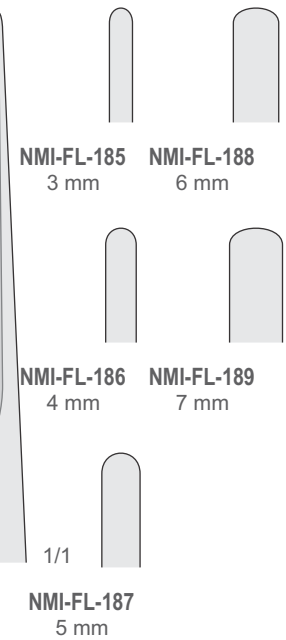
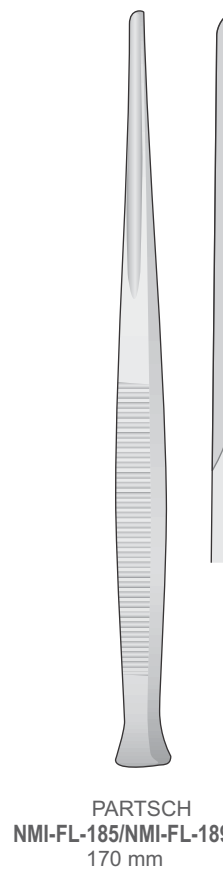
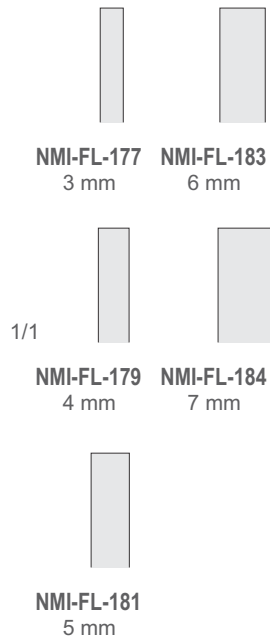
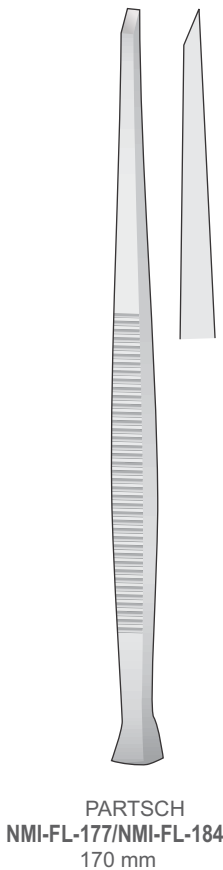
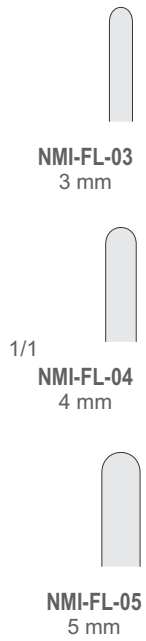
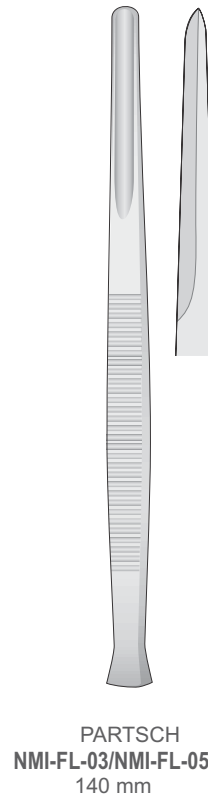
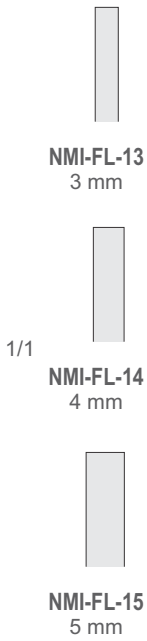
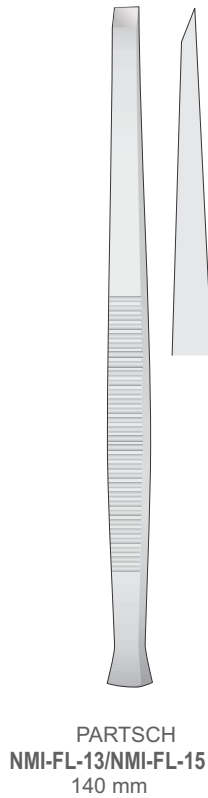
NMI-TG-32  
155 mm

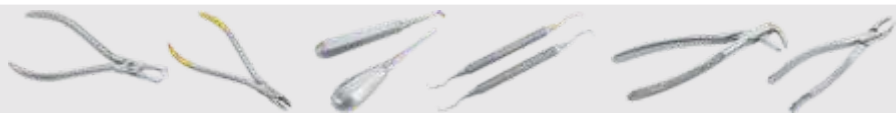
KRAMER-NEVINS  
NMI-KN-55/NMI-KN-75  
175 mm

NMI-DO-196  
180 mm

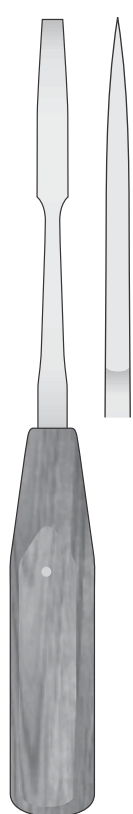


Osteotome - Hohlmeissel  
Osteotomes - Gouges  
Osteotomi - Scalpelli  
Osteótomos - Cinceles  
Ostéotomes - Scalpel





Osteotome - Meissel  
Osteotomes - Chisels  
Osteotomi - Scalpelli  
Osteótomos - Cinceles  
Ostéotomes - Burins



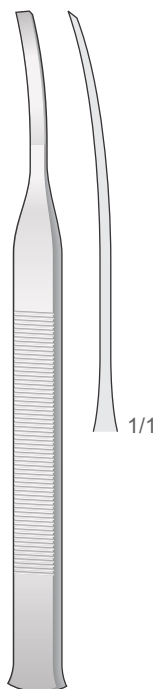
2 mm  
NMI-FL-59  
4 mm  
NMI-FL-60  
6 mm  
NMI-FL-61

1/1



4 mm  
NMI-FL-230  
6 mm  
NMI-FL-231  
8 mm  
NMI-FL-232

1/1



1/1

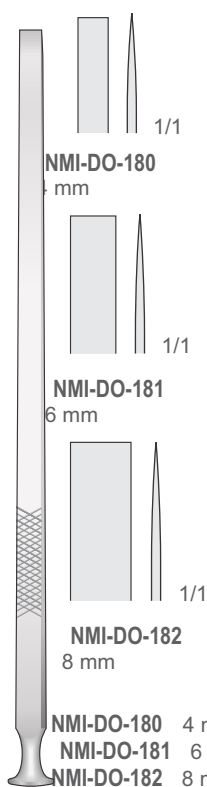


1/1  
NMI-FL-413  
2 mm  
NMI-FL-414  
3 mm  
NMI-FL-415  
5 mm  
NMI-FL-416  
7 mm

MINI-LEXER  
NMI-FL-59/NMI-FL-61  
200 mm

MINI-LEXER  
NMI-FL-230/NMI-FL-232  
180 mm

TESSIER  
NMI-FL-41  
15 mm  
NMI-FL-412  
7  
NMI-FL-413/NMI-FL-416  
160 mm



NMI-DO-180  
4 mm

NMI-DO-181  
6 mm

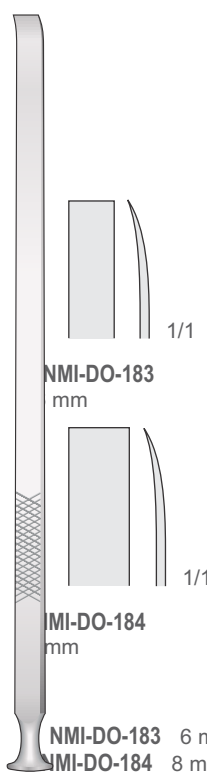
NMI-DO-182  
8 mm

NMI-DO-180  
4 mm  
NMI-DO-181  
6 mm  
NMI-DO-182  
8 mm

1/1

1/1

1/1



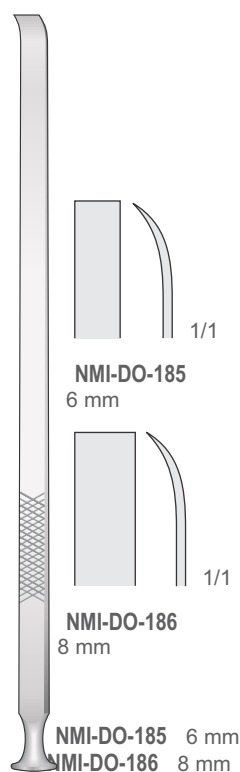
NMI-DO-183  
6 mm

NMI-DO-184  
8 mm

NMI-DO-183  
6 mm  
NMI-DO-184  
8 mm

1/1

1/1



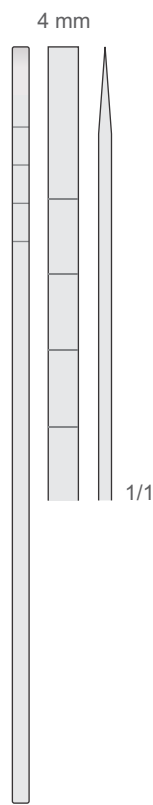
NMI-DO-185  
6 mm

NMI-DO-186  
8 mm

NMI-DO-185  
6 mm  
NMI-DO-186  
8 mm

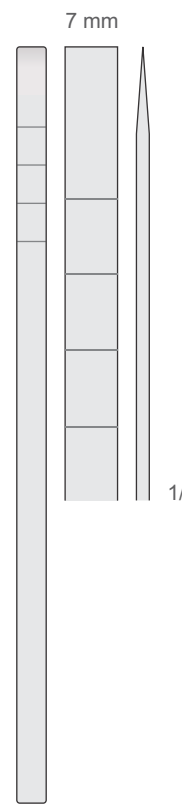
1/1

1/1



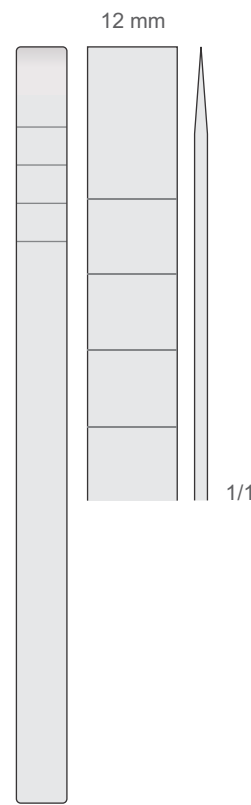
4 mm

1/1



7 mm

1/1



12 mm

1/1

EPKER  
NMI-DO-180  
NMI-DO-182  
180 mm

EPKER  
NMI-DO-183  
NMI-DO-184  
180 mm

EPKER  
NMI-DO-185  
NMI-DO-186  
180 mm

COTTLE  
NMI-DO-140  
180 mm

COTTLE  
NMI-DO-141  
180 mm

COTTLE  
NMI-DO-143  
180 mm



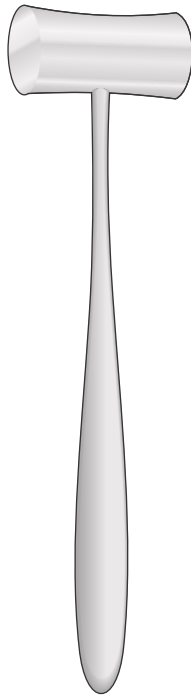
Chirurgische Hämmer  
Surgical mallets  
Martelli chirurgici  
Martillos quirúrgicos  
Maillets chirurgicaux

Ø 20 mm - 140 g



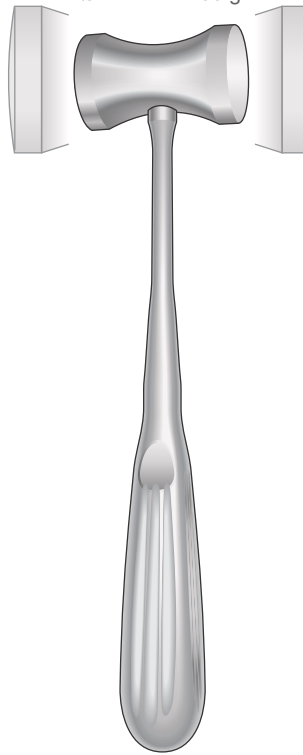
**NMI-FL-01**  
165 mm

Ø 25 mm - 300 g



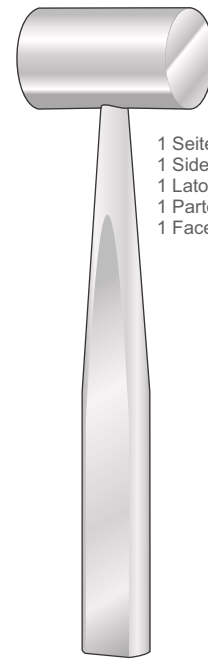
**LUCAE**  
**NMI-FL-10M**  
190 mm

Ø 27 mm - 135 g



**HAJEK**  
**NMI-FL-128**  
200 mm

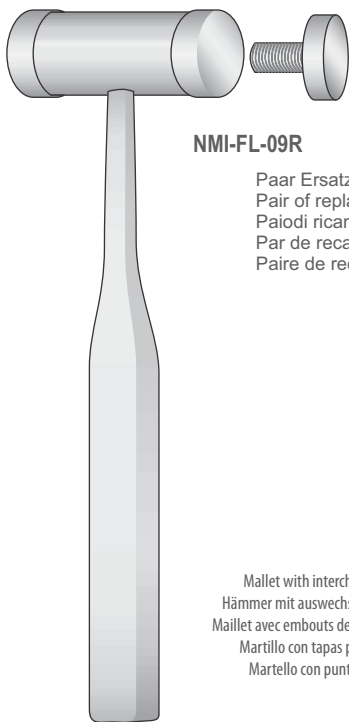
Ø 30 mm - 240 g



**COTTLE**  
**NMI-FL-104**  
185 mm

1 Seite flach - 1 Seite convex  
1 Side flat - 1 Side convex  
1 Lato piatto - 1 Lato convesso  
1 Parte plana - 1 Parte convexe  
1 Face plate - 1 Face convexe

Ø 20 mm - 160 g



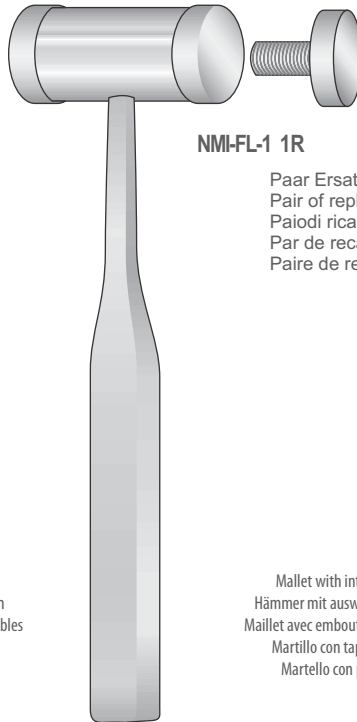
**NMI-FL-09R**

Paar Ersatzbacken  
Pair of replacement  
Paiodi ricambio  
Par de recambio  
Paire de rechange

Mallet with interchangeable plastic disks  
Hämmer mit auswechselbaren Kunststoffbacken  
Maillet avec embouts de plastique interchangeables  
Martillo con tapas plásticas reemplazables  
Martello con punte de ricambi in teon

**MEAD**  
**NMI-FL-09**  
190 mm

Ø 25 mm - 200 g



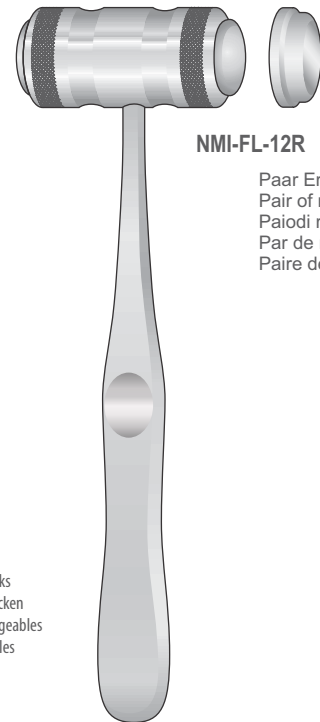
**NMI-FL-1 R**

Paar Ersatzbacken  
Pair of replacement  
Paiodi ricambio  
Par de recambio  
Paire de rechange

Mallet with interchangeable plastic disks  
Hämmer mit auswechselbaren Kunststoffbacken  
Maillet avec embouts de plastique interchangeables  
Martillo con tapas plásticas reemplazables  
Martello con punte de ricambi in teon

**MEAD**  
**NMI-FL-1**  
200 mm

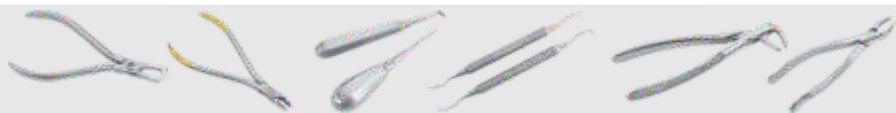
Ø 26 mm - 320 g



**NMI-FL-12R**

Paar Ersatzbacken  
Pair of replacement  
Paiodi ricambio  
Par de recambio  
Paire de rechange

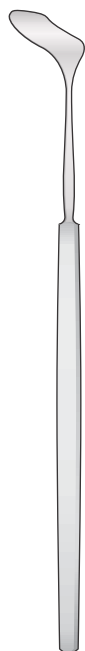
**MEAD**  
**NMI-FL-12**  
190 mm



Sinus Lift Retraktoren - Sinus Lift Retractors  
Divaricatori per Sinus Lift - Separadores para Sinus Lift  
Écarteurs pour Sinus Lift

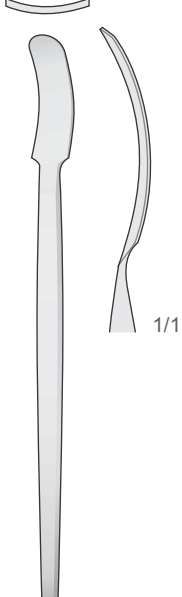
Raspatorien  
Periosteals  
Scollaperiosteai  
Periostótomos  
Rugines

17 mm



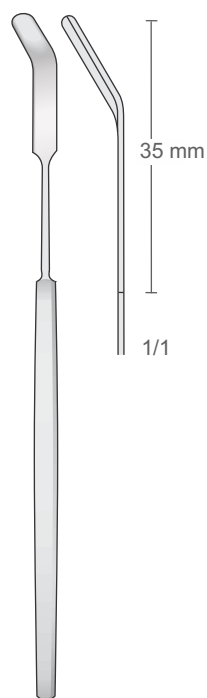
**SAUTTER**  
**NMI-NK-249**  
145 mm

11 mm

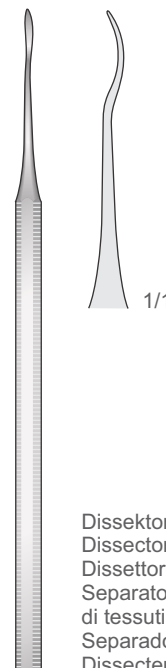


**NMI-NK-105**  
125 mm

9 mm



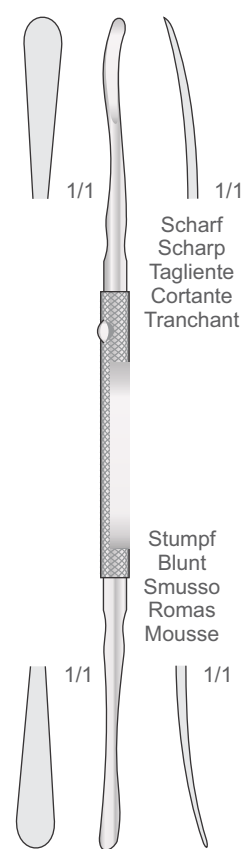
**MODELL GIESSEN**  
**NMI-NK-251**  
160 mm



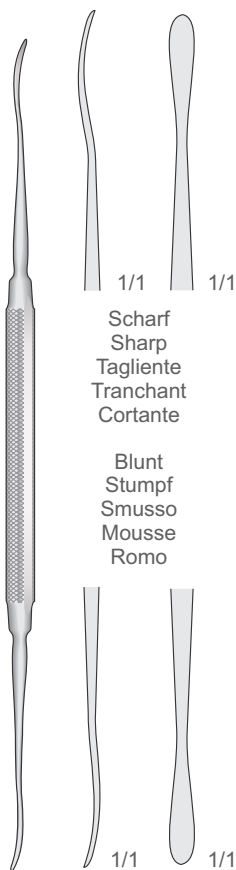
Dissektor  
Dissector  
Dissetore  
Separatore  
di tessuti  
Separadores  
Dissecteur

**NMI-ES-13**  
135 mm

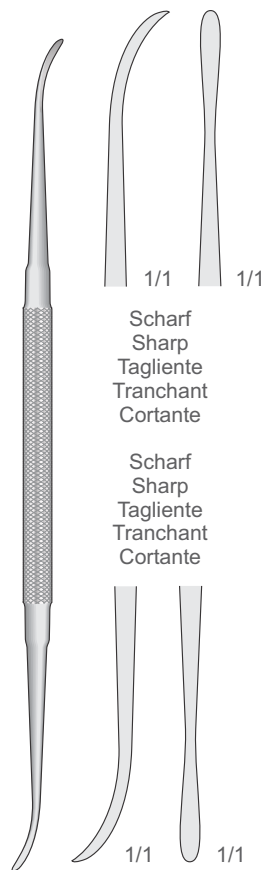
4.5 mm



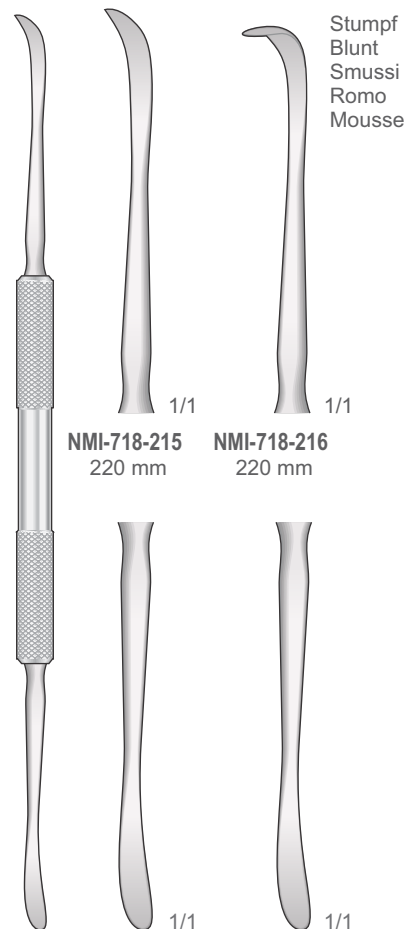
**FREER**  
180 mm



**FREER**  
**NMI-FR-16**  
185 mm



**FREER-YASARGIL**  
**NMI-FR-17**  
185 mm



**OBWEGESER-FREER**  
**NMI-718-215/NMI-718-216**  
220 mm

Stumpf  
Blunt  
Smussi  
Romo  
Mousse



Trepanbohrer  
Trepines  
Trepine  
Trépanos  
Trépan

**Combination Trocar-Trepine Instruments**

Bestehend aus einem

Trokar. einer

Ø 5 mm

gezahnten Trepine und einem Kolben zur Entnahme von Knochentransplantaten aus Tibia und Beckenkamm mittels eines geschlossenen Verfahrens

Consisting of trocar, a toothed trephine and a plunger for taking tibial and iliac bone grafts through a closed technique

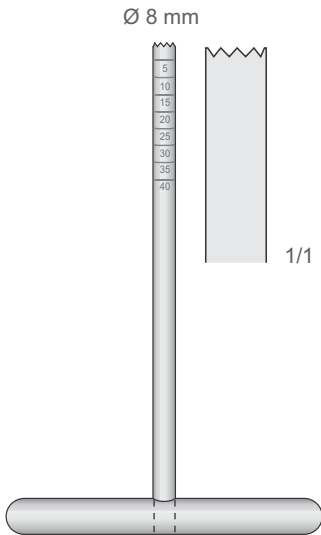
Composto di un trequarti, una camicia dentata ed un pistone per il prelievo degli innesti ossei dalla tibia e dalla cresta iliaca tramite una tecnica chirurgica intracutanea

Compuesto por un trócar, un trépano dentado y un émbolo para obtener injertos óseos tibiales e iliacos mediante una técnica cerrada

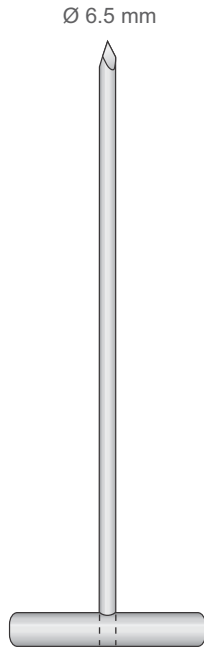
Composé d'un trocart, d'une tréphine dentée et d'un piston pour le prélèvement de greffes osseuses de la tibia ou de la crête

iliacque par une technique fermée

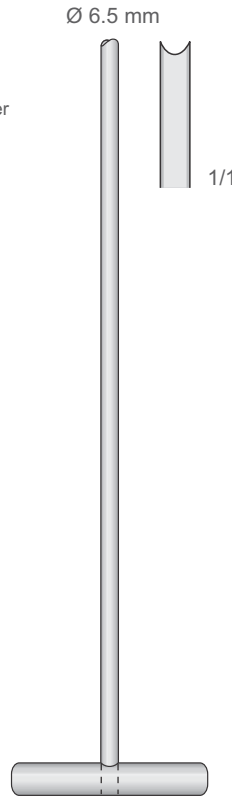
Set complete with 4 pieces  
Set completo di 4 pezzi  
Set completo con 4 piezas  
Set complet avec 4 pièces



**NMI-FK-100**  
Komplettset mit 4



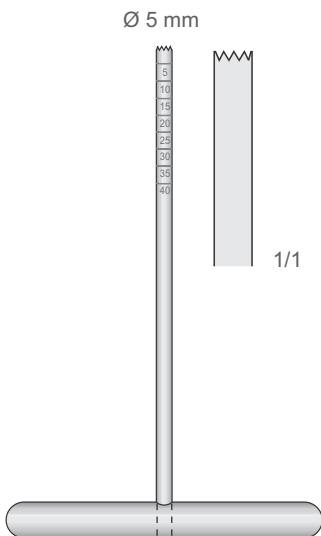
**NMI-FK-101**  
145 mm



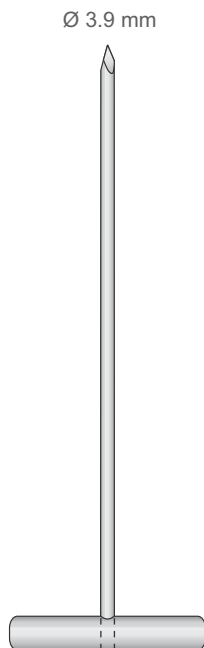
**NMI-FK-103**  
163 mm



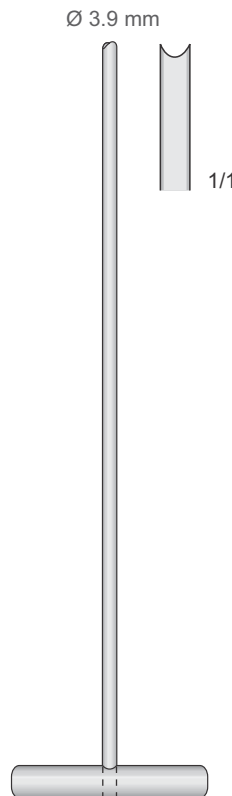
**NMI-FK-104**  
220 mm



**NMI-FK-105**  
145 mm



**NMI-FK-106**  
163 mm



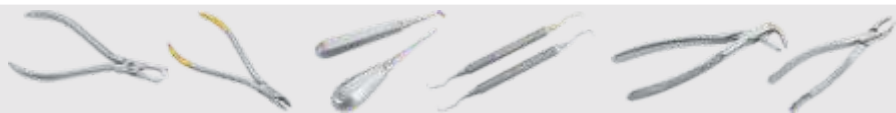
**NMI-FK-107**  
208 mm



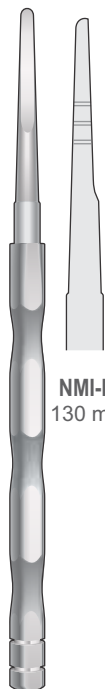
**NMI-FK-108**  
220 mm

Set complet avec 4 pièces  
Set complete with 4 pieces  
Set completo di 4 pezzi  
Set completo con 4 piezas

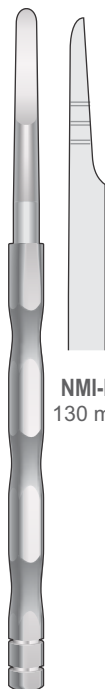
Teilen



Implantologie Instrumente  
Implantology Instruments  
Strumenti per implantologia  
Instrumentos para Implantología  
Instruments pour Implantologie



**NMI-MIR-30**  
130 mm



**NMI-MIR-31**  
130 mm



**NMI-MIR-32**  
130 mm

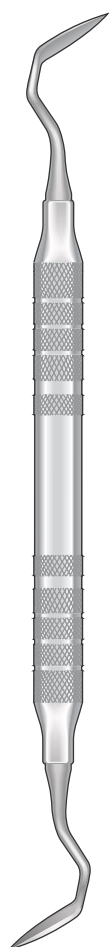


**NMI-MIR-33**  
130 mm

**BONE EXPANDERS**  
Distraktoren für Knochenleiste  
Distracteurs de crête osseuse  
Expansores de cresta ósea  
Distrattori per cresta ossea

**TUNNELING INSTRUMENTS**

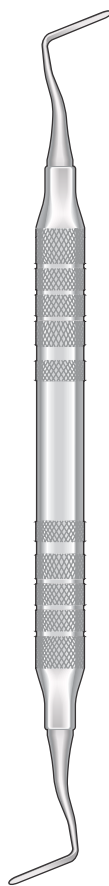
Tunnelierinstrumente | Instruments pour tunnellation | Instrumentos para tunelización | Strumenti per tunneling



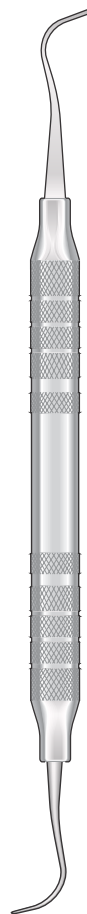
**NMI-UST-1/2ML**



**NMI-UST-1/2MS**



**NMI-UST-KPA**



**UNMI-SS-YG7/8**



**NMI-UST-MP**



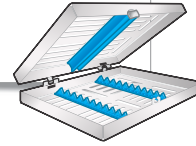
**NMI-UST-MPA**



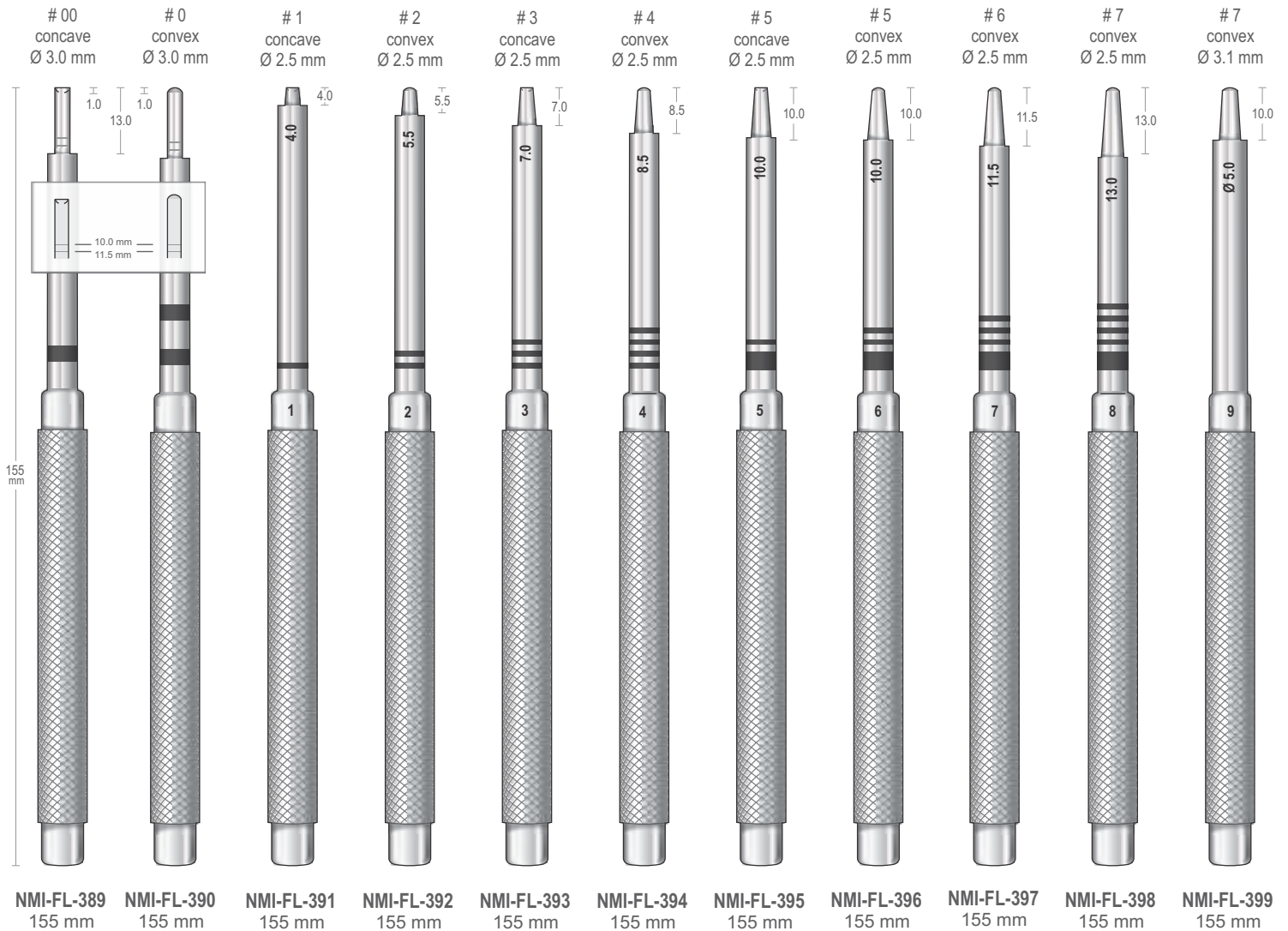
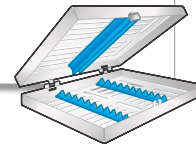
Osteotome  
Osteotomes  
Osteotomi  
Osteótomos  
Ostéotomes

**NMI-FL-400**  
**IMPLANT SINUS LIFT OSTEOT**  
NMI-FL-391 + NMI-FL-392 + NMI-FL-393 + NMI-FL-394  
+ NMI-FL-395 + NMI-FL-396 + NMI-FL-397 + NMI-FL-398 + NMI-FL-399  
(1 + 2 + 3 + 4 + 5 + 6 + 7 + 8 + 9)  
+ NMI-BS-60 (Stainless Steel Container)

OMES SET



**NMI-FL-400M**  
**COMPLETE IMPLANT SINUS LIFT OSTEOTOMES SET**  
NMI-FL-389 + NMI-FL-390 + NMI-FL-391 + NMI-FL-392 + NMI-FL-393  
+ NMI-FL-394 + NMI-FL-395 + NMI-FL-396 + NMI-FL-397 + NMI-FL-398 + NMI-FL-399  
(00 + 0 + 1 + 2 + 3 + 4 + 5 + 6 + 7 + 8 + 9)  
+ NMI-BS-60 (Stainless Steel Container)

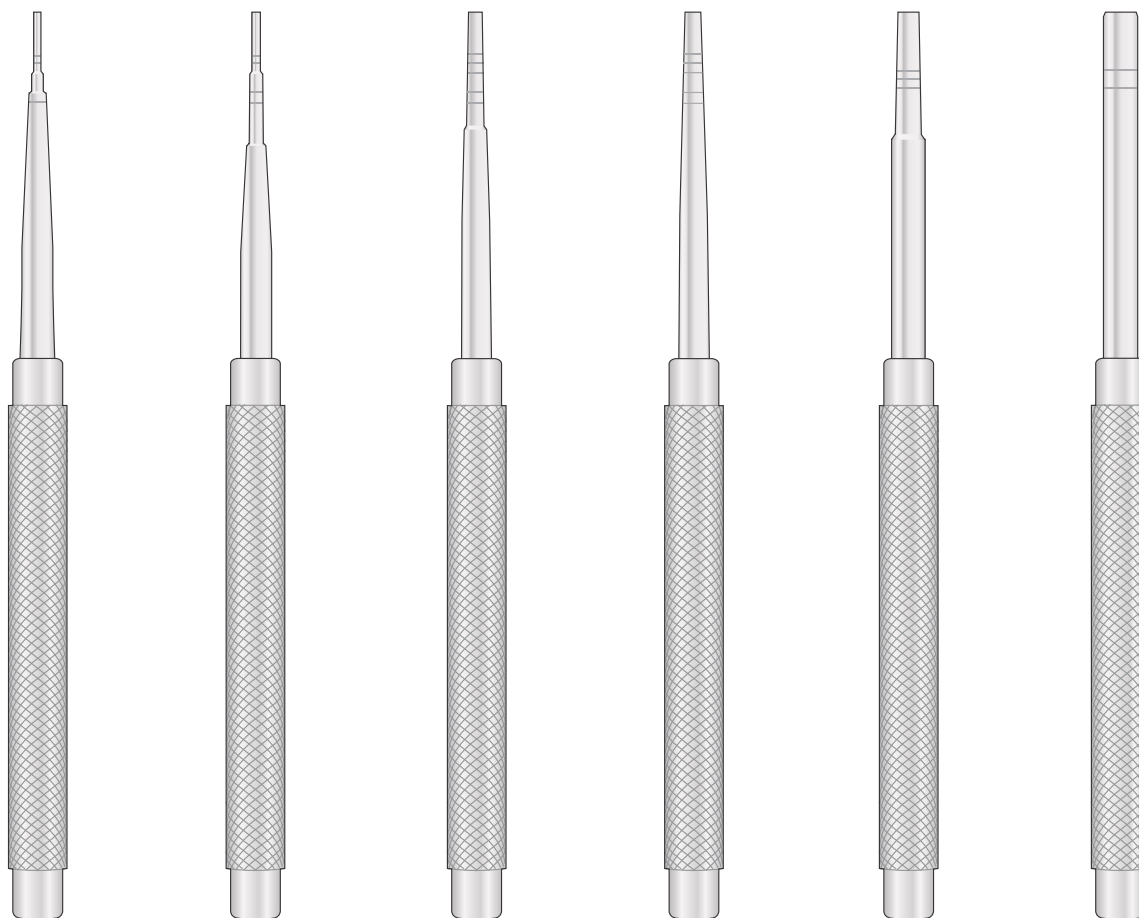




Osteotome  
Osteotomes  
Osteotomi  
Osteótomos  
Ostéotomes

# 1	Diam.	# 2	Diam.	# 3	Diam.	# 4	Diam.	# 5	Diam.	# 6	Diam.
0	Ø 1.60	0	Ø 1.90	0	Ø 2.80	0	Ø 3.10	0	Ø 3.90	0	Ø 5.50
7.5	Ø 1.80	7.5	Ø 2.20	7.5	Ø 3.20	7.5	Ø 3.70	10	Ø 5.00	10	Ø 6.20
10	Ø 2.00	10	Ø 2.35	10.5	Ø 3.35	10.5	Ø 3.90	13	Ø 5.20	13	Ø 6.30
13.5	Ø 2.40	13.5	Ø 3.30	13.5	Ø 3.60	15.5	Ø 4.30	20.5	Ø 6.30		
15.5	Ø 3.60	15.5	Ø 3.40	21	Ø 4.40						
		23.5	Ø 4.50								

# 1                      # 2                      # 3                      # 4                      # 5                      # 6  
 Ø 1.6 mm              Ø 1.9 mm              Ø 2.8 mm              Ø 3.10 mm              Ø 3.90 mm              Ø 5.50 mm



**NMI-FL-120**  
155 mm

**NMI-FL-121**  
155 mm

**NMI-FL-122**  
155 mm

**NMI-FL-123**  
155 mm

**NMI-FL-124**  
155 mm

**NMI-FL-125**  
155 mm

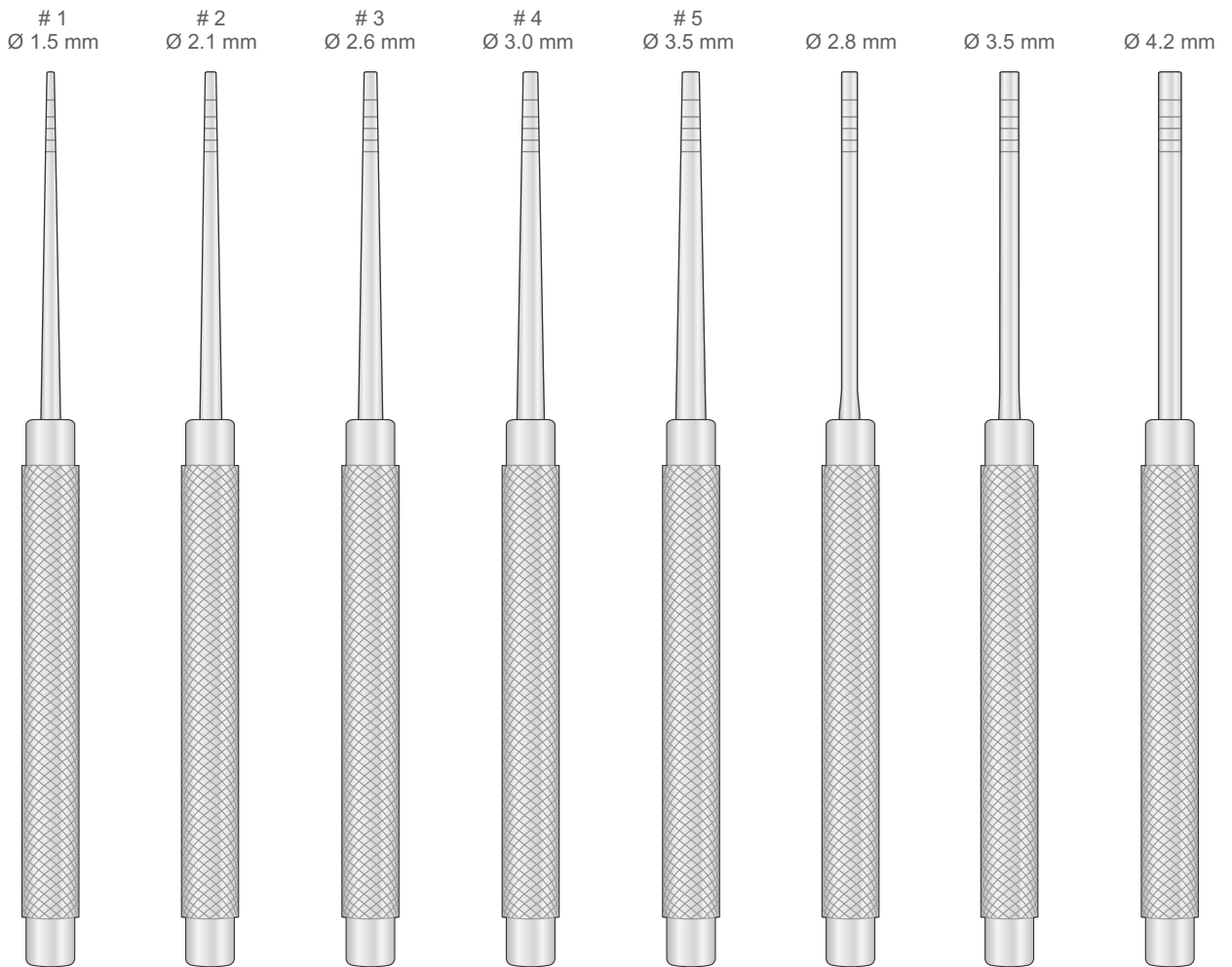


Osteotome  
Osteotomes  
Osteotomi  
Osteótomos  
Ostéotomes

#1	Diam.	#2	Diam.	#3	Diam.	#4	Diam.	#5	Diam.
0	Ø 1.50	0	Ø 2.10	0	Ø 2.60	0	Ø 3.00	0	Ø 3.50
5	Ø 1.90	5	Ø 2.60	5	Ø 3.00	5	Ø 3.50	5	Ø 3.90
8	Ø 2.20	8	Ø 2.80	8	Ø 3.30	8	Ø 3.80	8	Ø 4.20
10	Ø 2.40	10	Ø 3.00	10	Ø 3.50	10	Ø 4.00	10	Ø 4.40
12	Ø 2.60	12	Ø 3.20	12	Ø 3.70	12	Ø 4.20	12	Ø 4.60
14	Ø 2.80	14	Ø 3.40	14	Ø 3.90	14	Ø 4.40	14	Ø 4.80

Straight  
Gerade  
Droit  
Recto  
Diritto

Bone Pusher



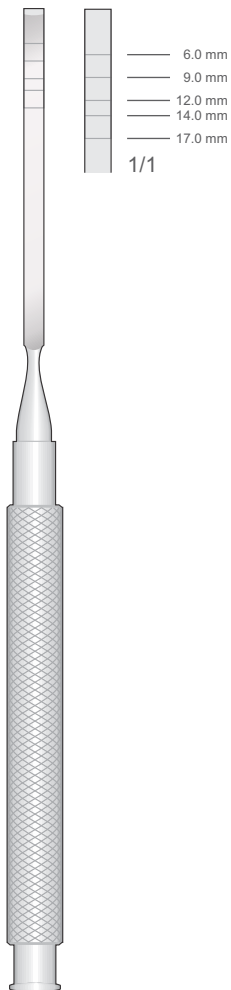
NMI-FL-292 55 mm	NMI-FL-293 155 mm	NMI-FL-294 155 mm	NMI-FL-295 155 mm	NMI-FL-296 155 mm	NMI-FL-297 155 mm	NMI-FL-298 155 mm	NMI-FL-299 155 mm
---------------------	----------------------	----------------------	----------------------	----------------------	----------------------	----------------------	----------------------



Osteotome  
Osteotomes  
Osteotomi  
Osteótomos  
Ostéotomes

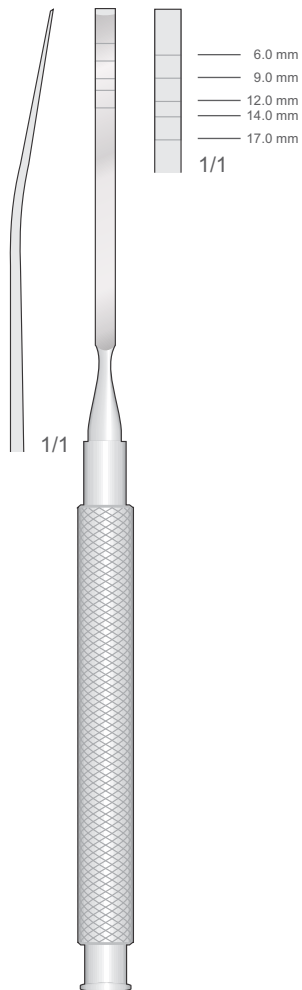
Meißeln Graduiert  
Graduated Chisels  
Scalpelli graduati  
Cinceles graduados  
Burins gradués

3.8 mm



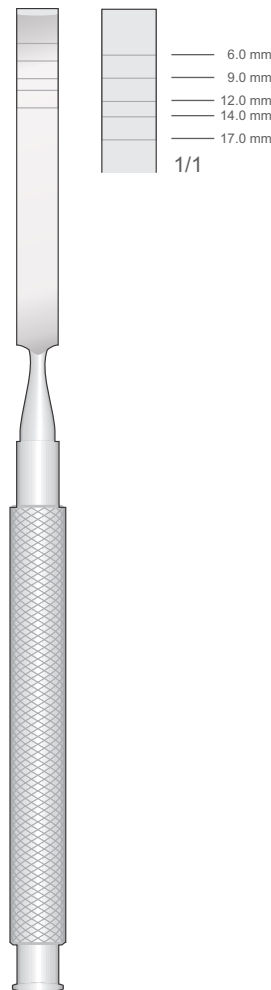
NMI-FL-141  
170 mm

3.8 mm



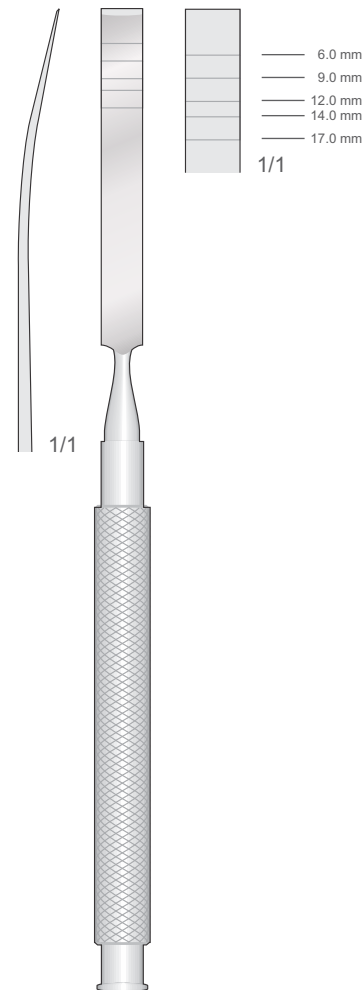
NMI-FL-142  
170 mm

7.5 mm



NMI-FL-143  
170 mm

7.5 mm



NMI-FL-144  
170 mm



Osteotome  
Osteotomes  
Osteotomi  
Osteótomos  
Ostéotomes

2 mm    3 mm    3.3 mm    4 mm

— 6 mm  
— 11 mm  
— 15 mm

NMI-FL-70    NMI-FL-71    NMI-FL-72    NMI-FL-73

Osteotome konkav mit Stop  
Osteotomes concave with Stop  
Osteotomi concavi con Stop  
Osteótomos cóncavos con Stop  
Ostéotomes concaves avec Stop

**NMI-FL-70/NMI-FL-73**  
165 mm

2 mm    3 mm    3.3 mm    4 mm

— 6 mm  
— 11 mm  
— 15 mm

NMI-FL-74    NMI-FL-75    NMI-FL-76    NMI-FL-77

Osteotome konkav mit Stop  
Osteotomes concave with Stop  
Osteotomi concavi con Stop  
Osteótomos cóncavos con Stop  
Ostéotomes concaves avec Stop

**NMI-FL-74/NMI-FL-77**  
165 mm

Ø 2 mm    Ø 3 mm    Ø 3.3 mm    Ø 4 mm

— 6 mm  
— 11 mm  
— 15 mm

NMI-FL-66    NMI-FL-67    NMI-FL-68    NMI-FL-69

Osteotome konvex mit Stop  
Osteotomes convex with Stop  
Osteotomi convessi con Stop  
Osteótomos convexos con Stop  
Ostéotomes convexes avec Stop

**NMI-FL-66/NMI-FL-69**  
165 mm

Ø 2 mm    Ø 3 mm    Ø 3.3 mm    Ø 4 mm

— 6 mm  
— 11 mm  
— 15 mm

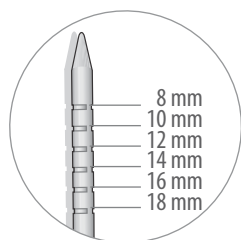
NMI-FL-65    NMI-FL-78    NMI-FL-79    NMI-FL-80

Osteotome konvex mit Stop  
Osteotomes convex with Stop  
Osteotomi convessi con Stop  
Osteótomos convexos con Stop  
Ostéotomes convexes avec Stop

**NMI-FL-65/NMI-FL-80**  
160 mm

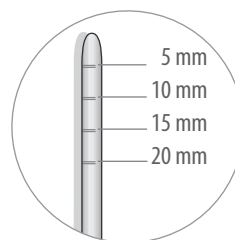


Osteotome  
Osteotomes  
Osteotomi  
Osteótomos  
Ostéotomes



Dilatator  
Dilator  
Dilatatori  
Dilatador  
Dilatateur

A-Form



Spreader  
Spreader  
Expansori  
Expansor  
Expandeur

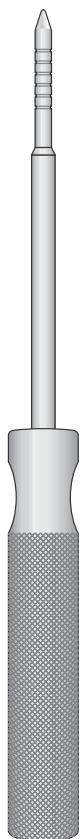
D-Form  
Convex Tip

Ø 2 mm



NMI-FL-25  
145 mm

Ø 3 mm



NMI-FL-26  
145 mm

Ø 3.3 mm



NMI-FL-27  
145 mm

Ø 4 mm



NMI-FL-28  
145 mm

Ø 3 mm



NMI-FL-37  
145 mm

Ø 4 mm



NMI-FL-38  
145 mm

Ø 5 mm



NMI-FL-39  
145 mm



Trepanbohrer  
Trepines  
Trepine  
Trépanos  
Trépan

Dentalschaft  
Dental Attack  
Attacco Dental

			Ø est. 6 mm Ø int. 5.5 mm	Ø est. 7 mm Ø int. 6.5 mm
Ø est. 3 mm Ø int. 2.5 mm	Ø est. 4.5 mm Ø int. 4 mm	Ø est. 5 mm Ø int. 4.5 mm		
15 mm				
1/1	1/1	1/1	1/1	1/1
<b>NMI-GA-33</b>	<b>NMI-GA-34</b>	<b>NMI-GA-35</b>	<b>NMI-GA-36</b>	<b>NMI-GA-37</b>

Zirkulirmesser - Circular knife  
Mucotomi. Bisturi circolari - Cuchillo circular  
Couteau circulaire

			Ø est. 6 mm Ø int. 5.5 mm
Ø est. 3 mm Ø int. 2.5 mm	Ø est. 4.5 mm Ø int. 4 mm	Ø est. 5 mm Ø int. 4.5 mm	
15 mm			
1/1	1/1	1/1	1/1
<b>NMI-GA-63</b>	<b>NMI-GA-64</b>	<b>NMI-GA-65</b>	<b>NMI-GA-66</b>

Hautstanzen - Tissue punches  
Mucotomi Punches - Instrumentos para cortar tejidos  
Instruments à couper le tissue

Implant Graduierung  
Implant depth gauge with ball end  
Sonda per controllare la profondità del sito  
Sonda para controlar la profundidad

	3 mm		<b>NMI-FL-150</b>
	4 mm		<b>NMI-FL-151</b>
	5 mm		<b>NMI-FL-152</b>
	6 mm		<b>NMI-FL-153</b>
	<b>KEYES</b>		
<b>NMI-FL-150/NMI-FL-153</b>			
100 mm			

	3 mm		<b>NMI-FL-155</b>
	4 mm		<b>NMI-FL-156</b>
	5 mm		<b>NMI-FL-157</b>
	6 mm		<b>NMI-FL-158</b>
	8 mm		<b>NMI-FL-159</b>
<b>KEYES</b>			
<b>NMI-FL-155/NMI-FL-159</b>			
90 mm			

	Ø 2.0 mm	
	Ø 1.5 mm	
<b>NMI-GA-60</b>		
100 mm		



Implantologie Instrumente  
Implantology Instruments  
Strumenti per implantologia  
Instrumentos para Implantología  
Instruments pour Implantologie

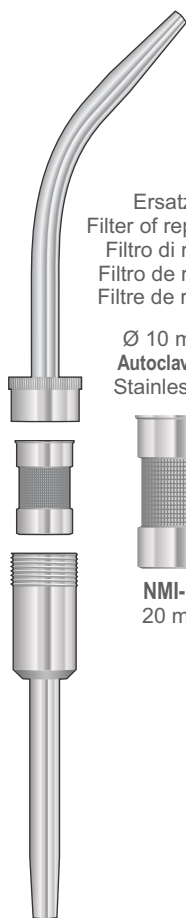
Knochenschale  
Bone Well  
Bacinella per osso  
Cubeta para hueso  
Cuvette à os



Rostfrei  
Stainless Steel  
Acciaio inossidabile  
Acero inoxidable  
Acier Inoxydable

**NMI-SS-65**  
35 mm

Absaugkanülen für Knochen. mit Filter  
Suction tube for bone. with filter  
Cannule d'aspiration avec trattenuta osso. con filtro  
Cánulas aspiradoras para hueso. con filtro  
Canule d'aspiration pour os avec filtre



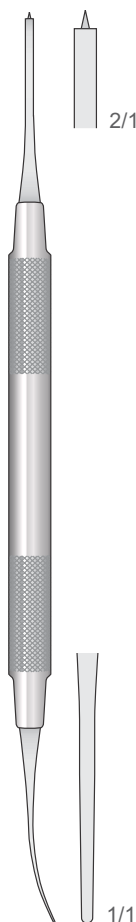
Ersatzfilter  
Filter of replacement  
Filtro di ricambio  
Filtro de recambio  
Filtre de recharge

Ø 10 mm int.  
Autoclavable  
Stainless Steel



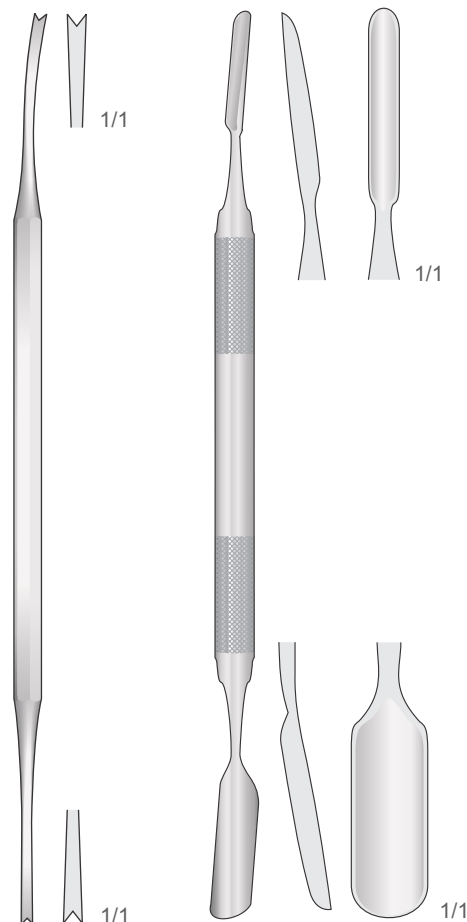
**NMI-GF-133**  
180 mm

Membranplatzierungsinstrumente  
Membrane Placement Instruments  
Strumenti per posizionare membrana  
Instrumentos para colocar membranas  
Instruments pour application de membrane



**NMI-MPI-1**  
185 mm

Aufbring Instrument für Knochenmaterial  
Applicator for bone material  
Aplicatore per materiale osseo  
Cucharillas para material osseo  
Applicateur pour matière osseuse



LUNIATSCHEK  
**NMI-PF-6**  
170 mm

**NMI-IM-15**  
180 mm



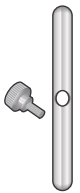
Knochenmühlen - und spritzen  
Bone Mills and Syringes  
Macina e siringhe per osso  
Molinos y jeringas para hueso  
Moulines et seringues à os



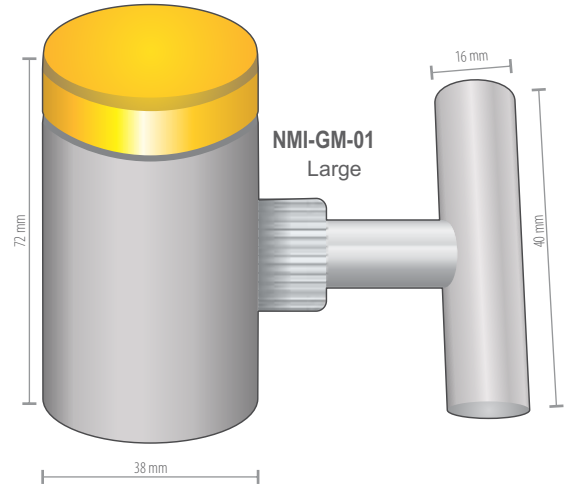
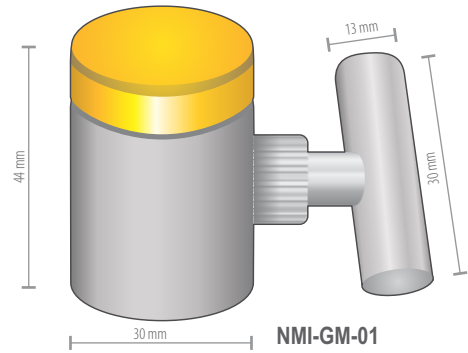
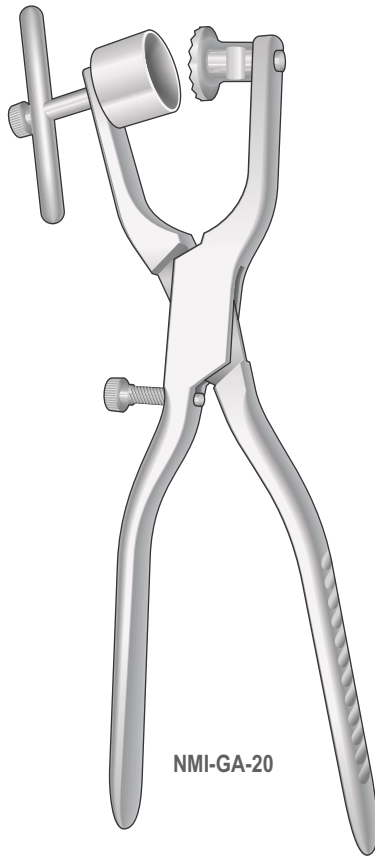
**NMI-GA-18**  
Lower  
Titanium



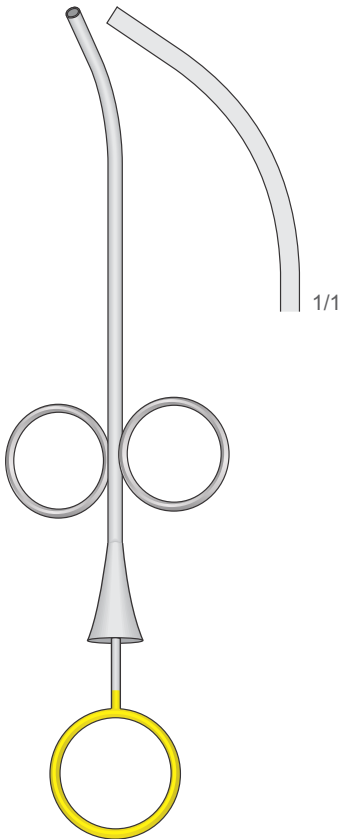
**NMI-GA-17**  
Upper  
Titanium



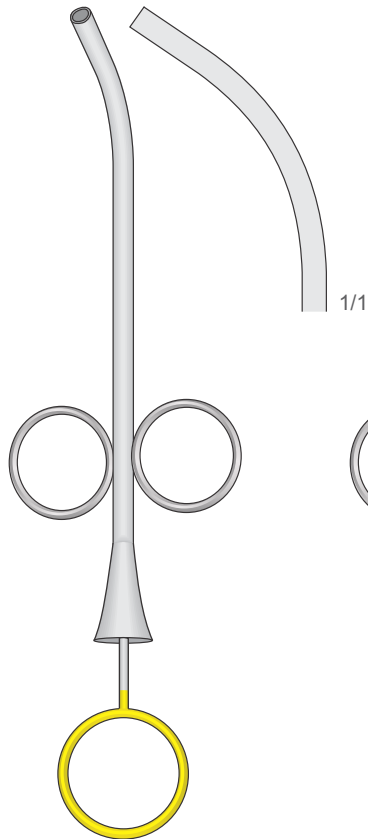
**NMI-GA-19**  
Handle  
with screw



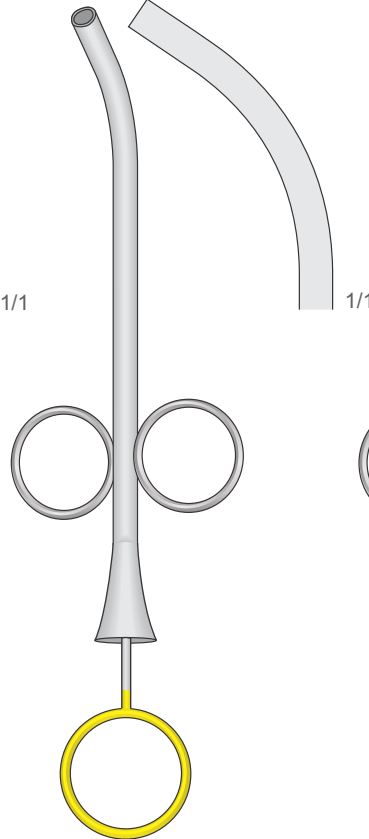
Ø Int. 2.5 mm  
Ø Est. 3.5 mm



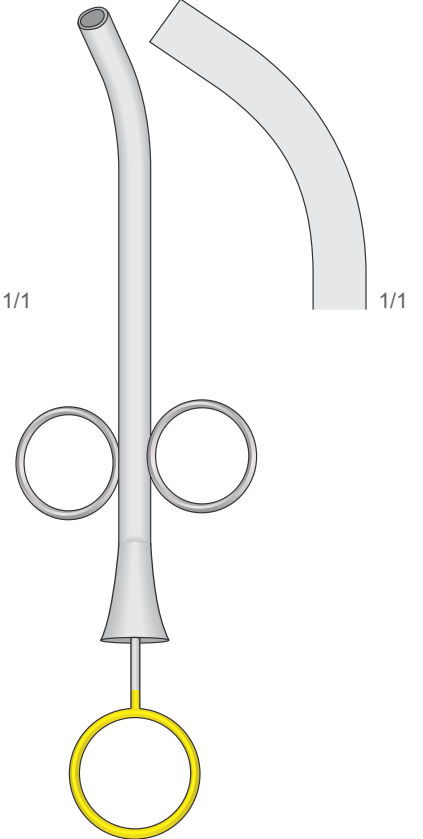
Ø Int. 3.5 mm  
Ø Est. 4.5 mm



Ø Int. 4.4 mm  
Ø Est. 5.5 mm

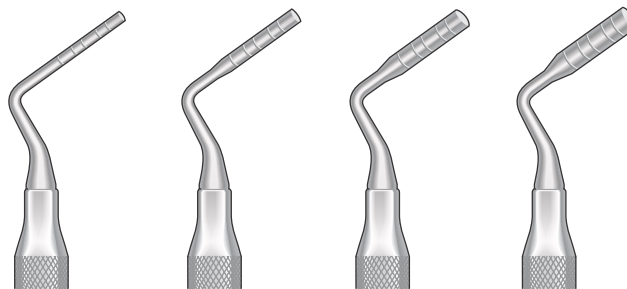
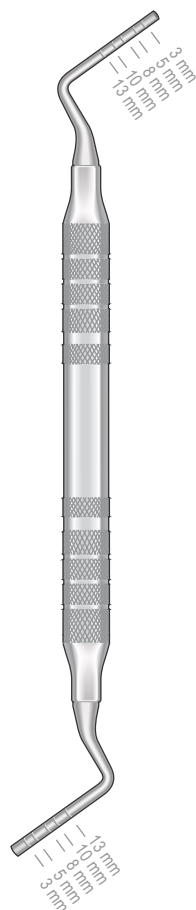


Ø Int. 6 mm  
Ø Est. 7 mm





Knochenstopfer  
Bone Tampers - Bone Grafting Packers  
Compattatore per osso  
Compactador para hueso  
Compacteur à os



	Non Serrated Tips		Serrated Tips	
NMI-USB-P1	○ Ø 1.8	○ Ø 2.8	● Ø 1.8	● Ø 2.8
NMI-USB-P2	○ Ø 3.2	○ Ø 3.8	● Ø 3.2	● Ø 3.8
NMI-USB-P3	○ Ø 4.2	○ Ø 4.8	● Ø 4.2	● Ø 4.8
NMI-USB-P4	○ Ø 5.0	○ Ø 5.5	● Ø 5.0	● Ø 5.5

Ø 3 mm



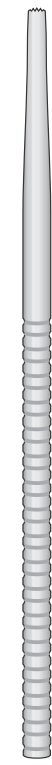
NMI-FL-20  
155 mm

Ø 5 mm



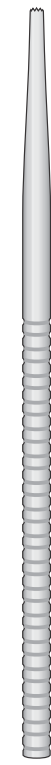
NMI-FL-21  
155 mm

Ø 4 mm



NMI-FL-31  
155 mm

Ø 3 mm



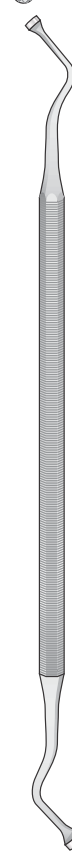
NMI-FL-33  
155 mm

Ø 5 mm



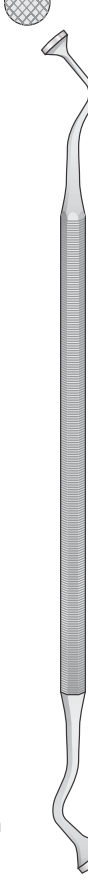
NMI-FL-35  
155 mm

3 mm



NMI-ONMI-P-7  
170 mm

6 mm

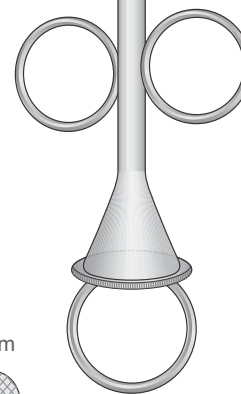


NMI-ONMI-P-8  
170 mm

4 mm



8 mm



FOITZIK  
NMI-SS-20/NMI-SS-22  
140 mm

Misura interna



NMI-SS-20 Ø 3 mm



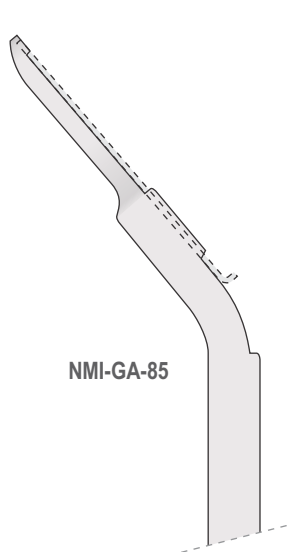
NMI-SS-21 Ø 4 mm



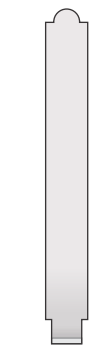
NMI-SS-22 Ø 5 mm



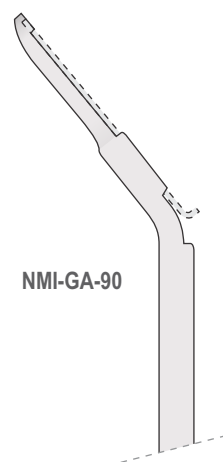
Knochenschaber. Rostfrei Stahl  
Bone-Grafter. Stainless Steel  
Grattini per osso. Inox  
Raspador de hueso. Acero inoxidable  
Racleur d'os. Acier inoxydable



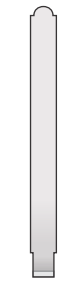
**NMI-GA-85**



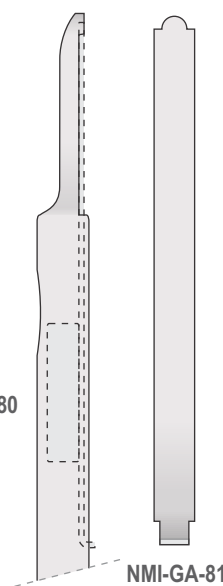
**NMI-GA-86**



**NMI-GA-90**



**NMI-GA-91**

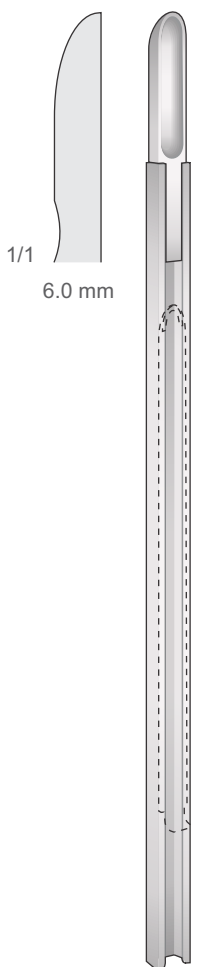


**NMI-GA-80**

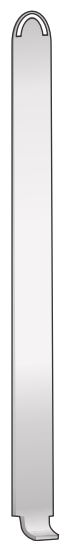


**NMI-GA-81**

Knochenschaber mit Reibeklinge  
Bone-Grafter with blade  
Grattino con lama  
Raspador de hueso con hoja  
Racleur d'os avec lame

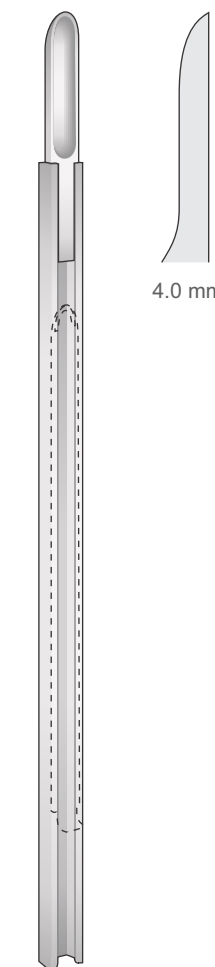


**NMI-GA-70**  
170 mm

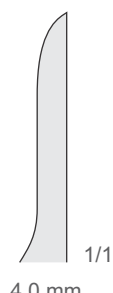


**NMI-GA-71**  
90 mm

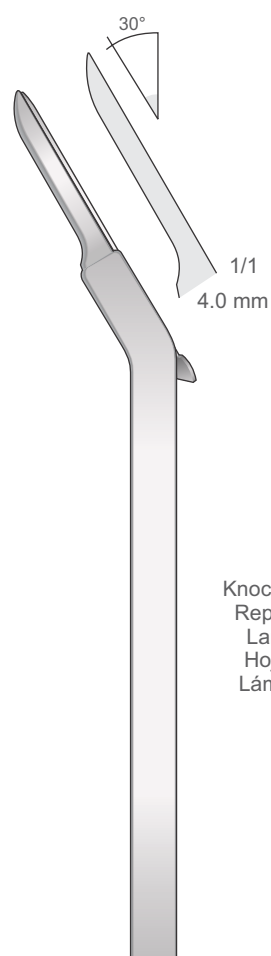
Knochenreibeschlinge  
Replacement Blade  
Lama di ricambio  
Hoja de recambio  
Lâme de rechange



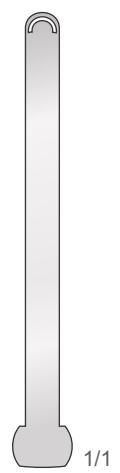
**NMI-GA-73**  
170 mm



1/1  
4.0 mm



**NMI-GA-78**  
155 mm



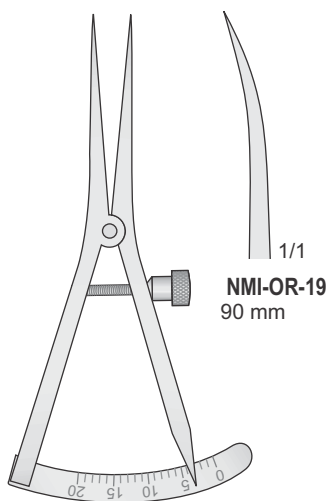
1/1  
**NMI-GA-79**  
60 mm

Knochenreibeschlinge  
Replacement Blade  
Lama di ricambio  
Hoja de recambio  
Lâme de rechange



Messinstrumente  
Measuring instruments  
Strumenti per misura  
Instrumentos para medir  
Instruments à mesurer

Meßbereich: 0 - 20 mm  
Measuring range: 0 - 20 mm  
Campo di misura: 0 - 20 mm  
Alcance de medición: 0 - 20 mm  
Etendue de mesure: 0 - 20 mm



**NMI-OR-19**  
CASTROVIEJO  
90 mm



**NMI-LS-08**  
100 mm

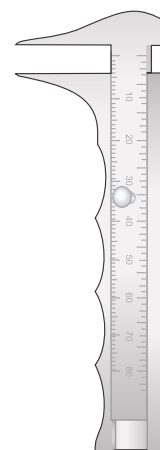


**NMI-LS-09**  
200 mm

Meßbereich: 0 - 80 mm  
Measuring range: 0 - 80 mm  
Campo di misura: 0 - 80 mm  
Alcance de medición: 0 - 80 mm  
Etendue de mesure: 0 - 80 mm

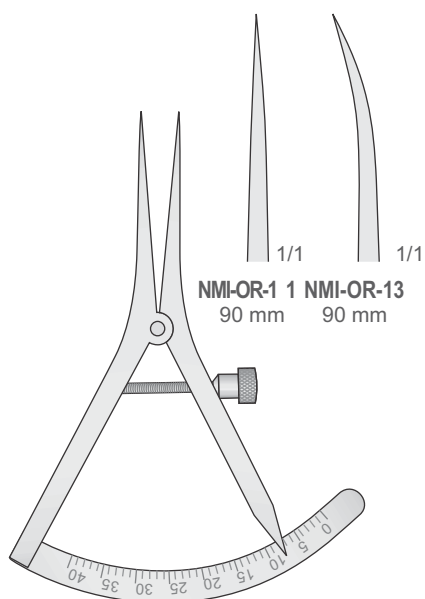


**NMI-OR-40**  
125 mm

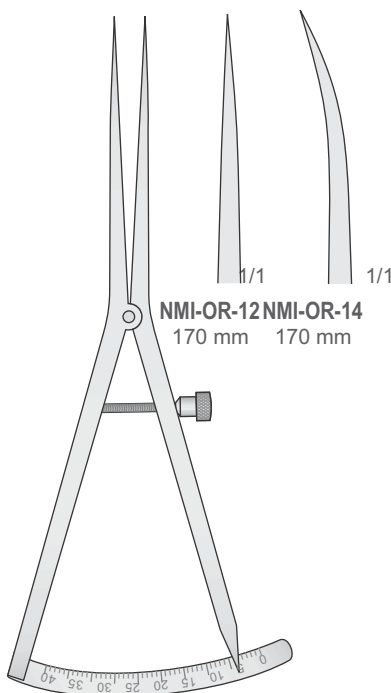


**NMI-OR-45**  
95 mm

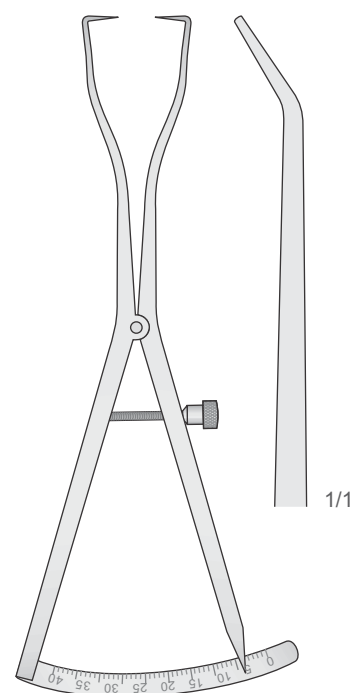
0 - 40 mm  
Meßbereich / Measuring range / Campo di misura  
Alcance de medición / Etendue de mesure



**CASTROVIEJO**  
**NMI-OR-1 1/NMI-OR-13**  
90 mm



**CASTROVIEJO**  
**NMI-OR-12/NMI-OR-14**  
170 mm

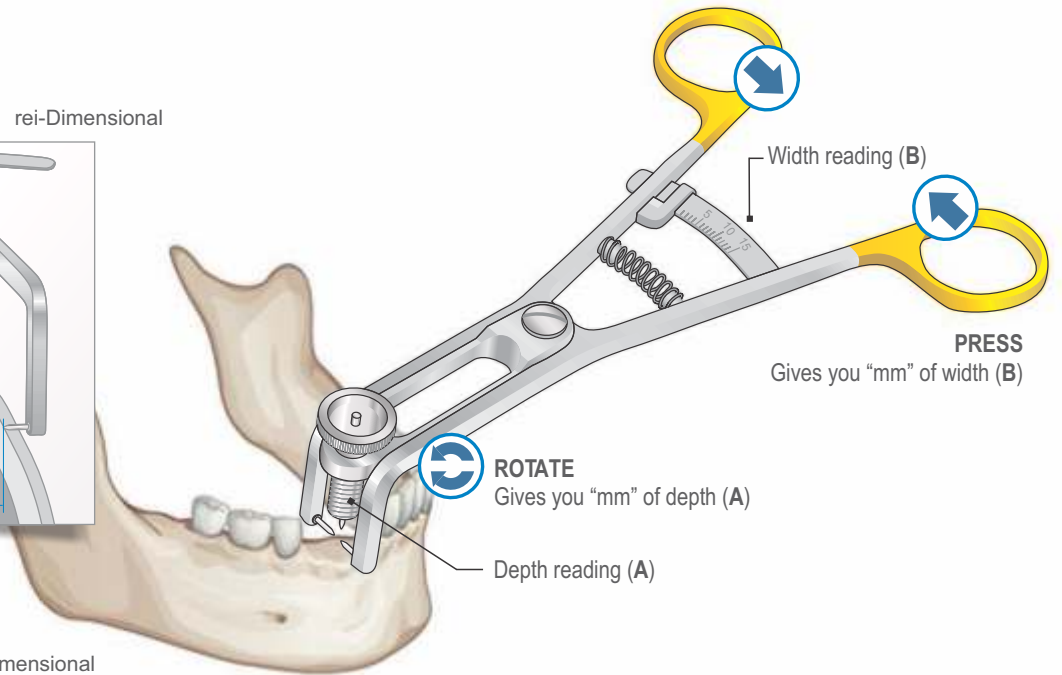
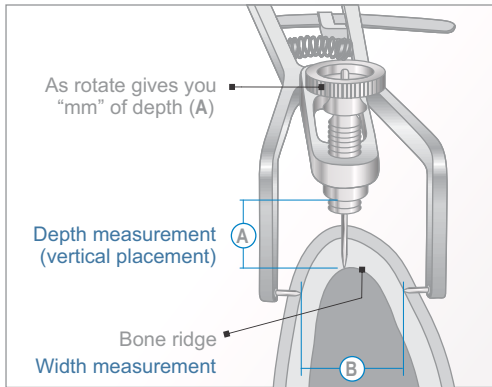


**CASTROVIEJO**  
**NMI-OR-18**  
170 mm



Osteometer  
Osteometer  
Osteometro  
Osteometro  
Osteometer

**TRIDIMENSIONAL IMPLANTOLOGY CALIPER** rei-Dimensional

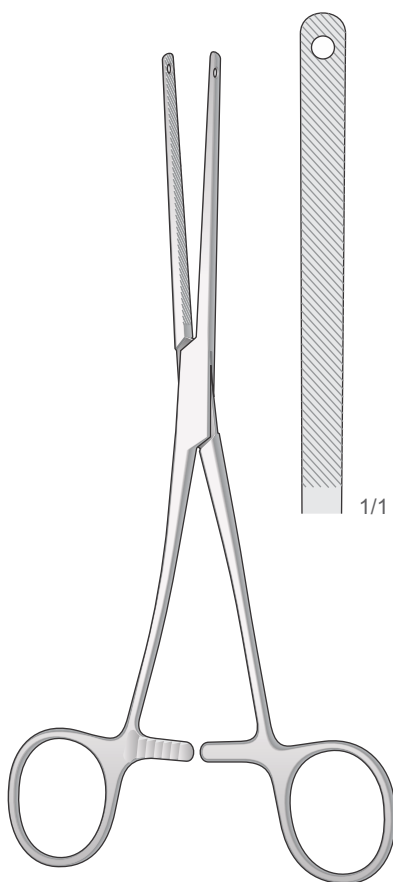


**DB-300**

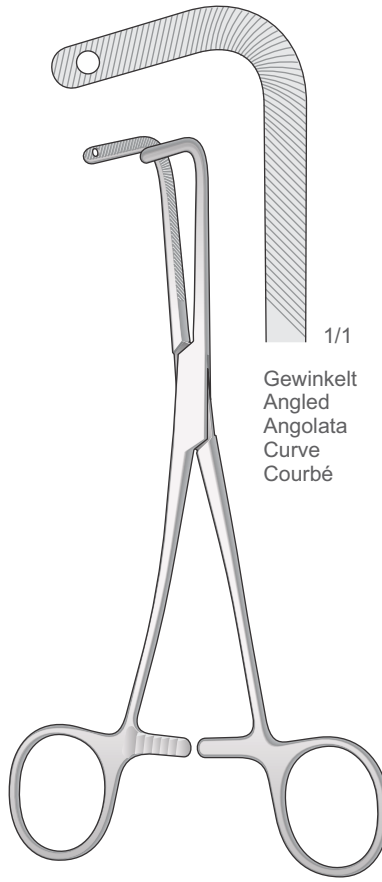
Schieblehre für Implantologie T  
Implantology Calliper  
Calibro per Implantologia  
Calibre para Implantología  
Calibre pour Implantologie

Tridimensional  
Tridimensionale  
Tridimensional  
Tridimensionnel

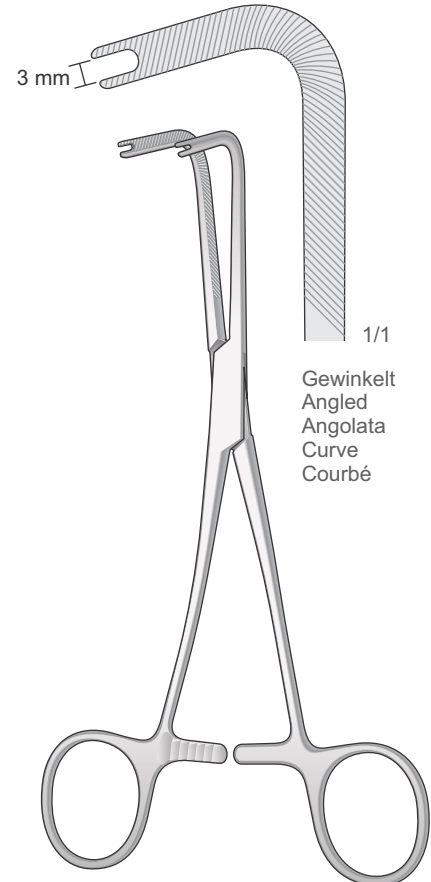
**BONE BLOCK CLAMP**  
Bone Holding Clamps  
Knochenhalteklammern  
Daviers à os  
Pinzas de sujeción para hueso  
Pinze per fissare l'osso



**NMI-P-340**  
220 mm



**NMI-P-341**  
200 mm

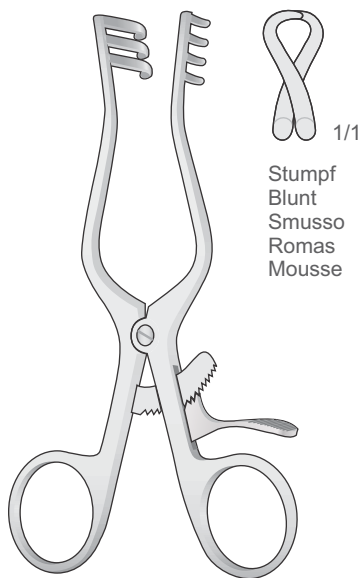


**NMI-P-342**  
200 mm



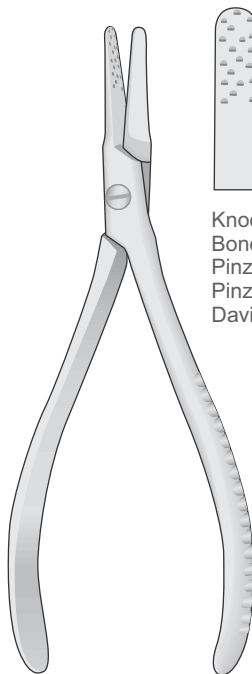
Retraktoren - Knochenhaltezange  
Retractors - Bone Holding Forceps  
Divaricatori - Pinza per fissare l'osso  
Separadores - Pinzas para sujeción para hueso  
Écarteurs - Daviers à os

Tibia Wundspreizer  
Tibial and Iliac Retractor  
Divaricatore per tibia e cresta iliaca  
Separadores tibiales e iliacos  
Écarteur pour tibia e crête iliaque

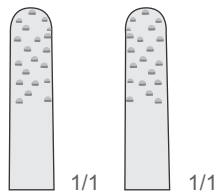


WEITLANER  
NMI-BV-23  
165 mm

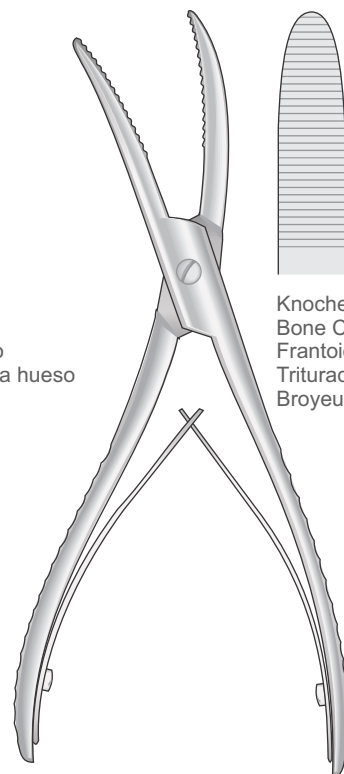
1/1  
Stumpf  
Blunt  
Smusso  
Romas  
Mousse



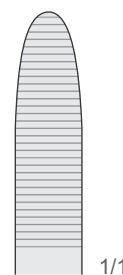
RADOLF  
NMI-FO-159  
135 mm



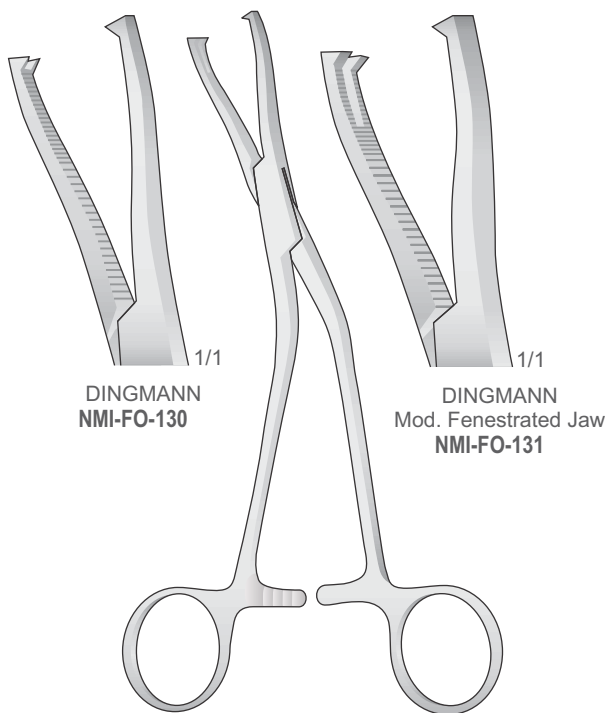
1/1 1/1  
Knochenhaltezange  
Bone Holding Forceps  
Pinza per fissare l'osso  
Pinzas de sujeción para hueso  
Daviers à os



WOLFF  
NMI-LX-1 13  
180 mm



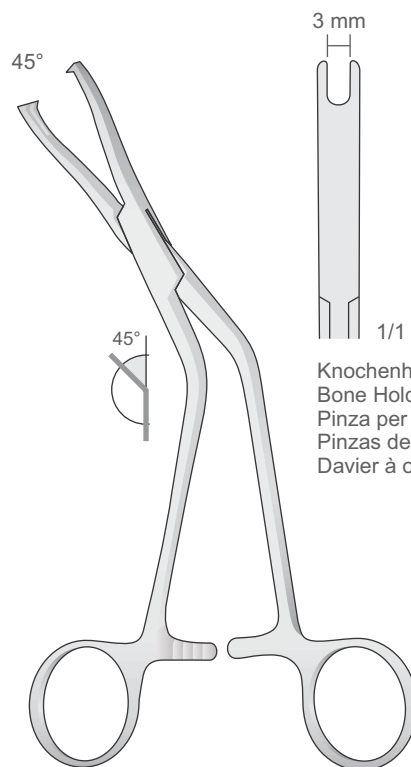
1/1  
Knochen-Quetsche  
Bone Crusher  
Frantoio per osso  
Triturador óseo  
Broyeur d'os



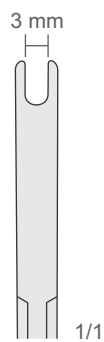
DINGMANN  
NMI-FO-130

DINGMANN  
Mod. Fenestrated Jaw  
NMI-FO-131

DINGMANN  
NMI-FO-130/NMI-FO-131  
190 mm



DINGMANN - Mod. Fenestrated Jaw  
NMI-FO-131S  
190 mm



1/1  
Knochenhaltezange  
Bone Holding Forceps  
Pinza per fissare l'osso  
Pinzas de sujeción para hueso  
Daviers à os

# DENTAL Instruments

Extracting Forceps

Root Elevators

Scalpel Blades and Handles

Surgical Scissors

Tissue and Dressing Forceps

Needle Holders

Hemostatic Forceps | Towel Clamps

Retractors | Mouth Gags

Implantology

Periosteal | Curettes | Rongeurs

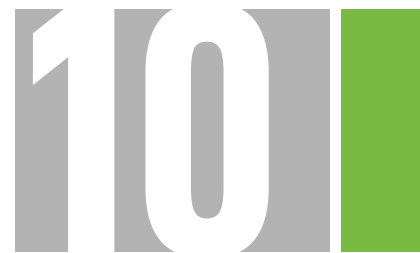
Dental Restoration | Periodontology

Suction Tube

Orthodontics

Crown Instruments | Laboratory

Instrument Maintenance | Sterilization



## Periosteals (Raspatories)

Raspatorien

Rugines périostiques

Periostótomos (Legras)

Scollaperiostei (Periostotomi)

## Curettes

Küretten

Curettes

Curetas

Curettes

## Bone files

Knochenfeilen

Limes à os

Limas para hueso

Lime per osso

## Tissue Nippers

Gewebezängchen

Pinces coupante pour tissu

Pinzas para cortar tejidos

Tronchesi per gengive e tessuto

## Bone Rongeurs

Hohlmeißelzangen

Pinces gouges

Pinzas gubias

Pinze ossivore

## Bone Cutting Forceps

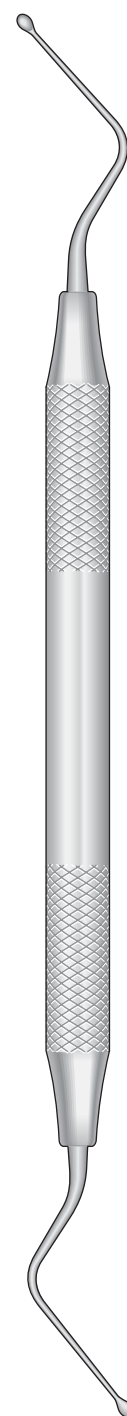
Knochensplitterzangen

Pinces coupantes à os

Pinzas cortantes para huesos

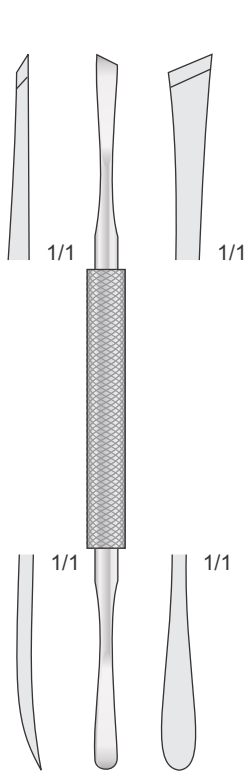
Pinze ossivore

214-238





Raspatorien  
Periosteals (Raspatories)  
Scollaperiosteai (Periostotomi)  
Periostótomos (Legras)  
Rugines périostiques



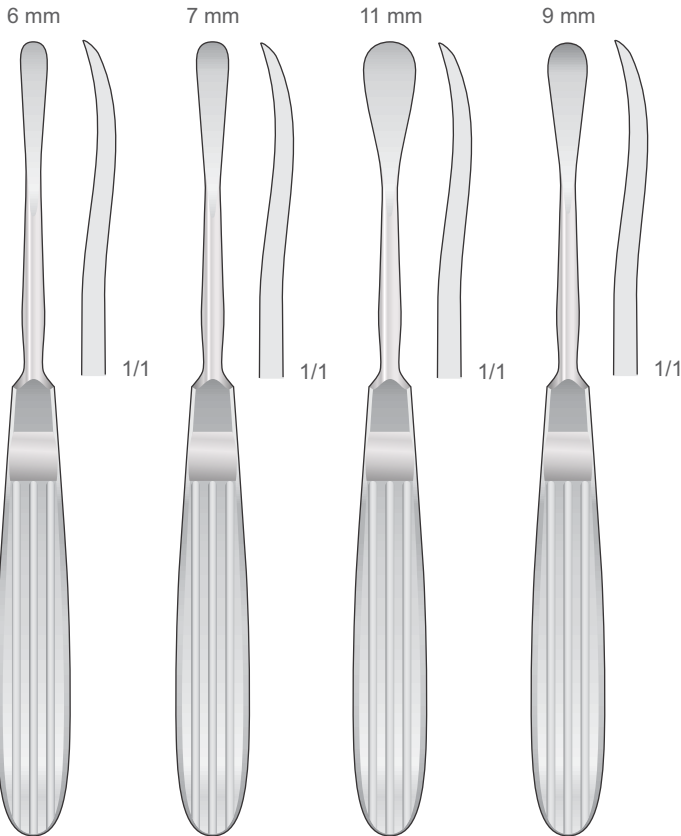
**MEAD**  
165 mm



**WEST**  
185 mm

**PERIOSTEAL  
ELEVATORS**

Scharf - Sharp - Taglienti - Cortante - Tranchant



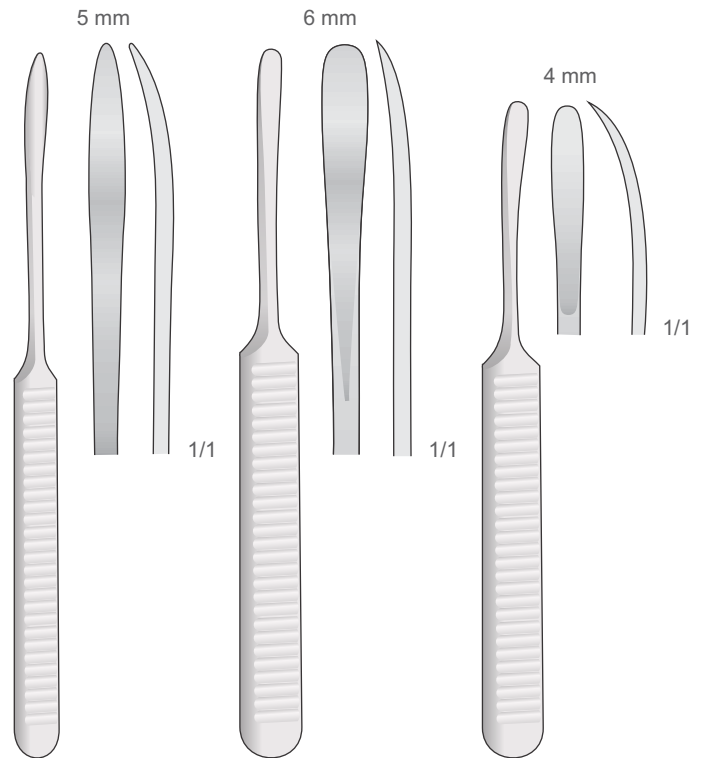
**OBWEGESER**  
**NMI-DO-59**  
175 mm

**OBWEGESER**  
**NMI-DO-63**  
175 mm

**OBWEGESER**  
**NMI-DO-65**  
175 mm

**OBWEGESER**  
**NMI-DO-67**  
175 mm

**PERIOSTEAL  
RASPATORIES**



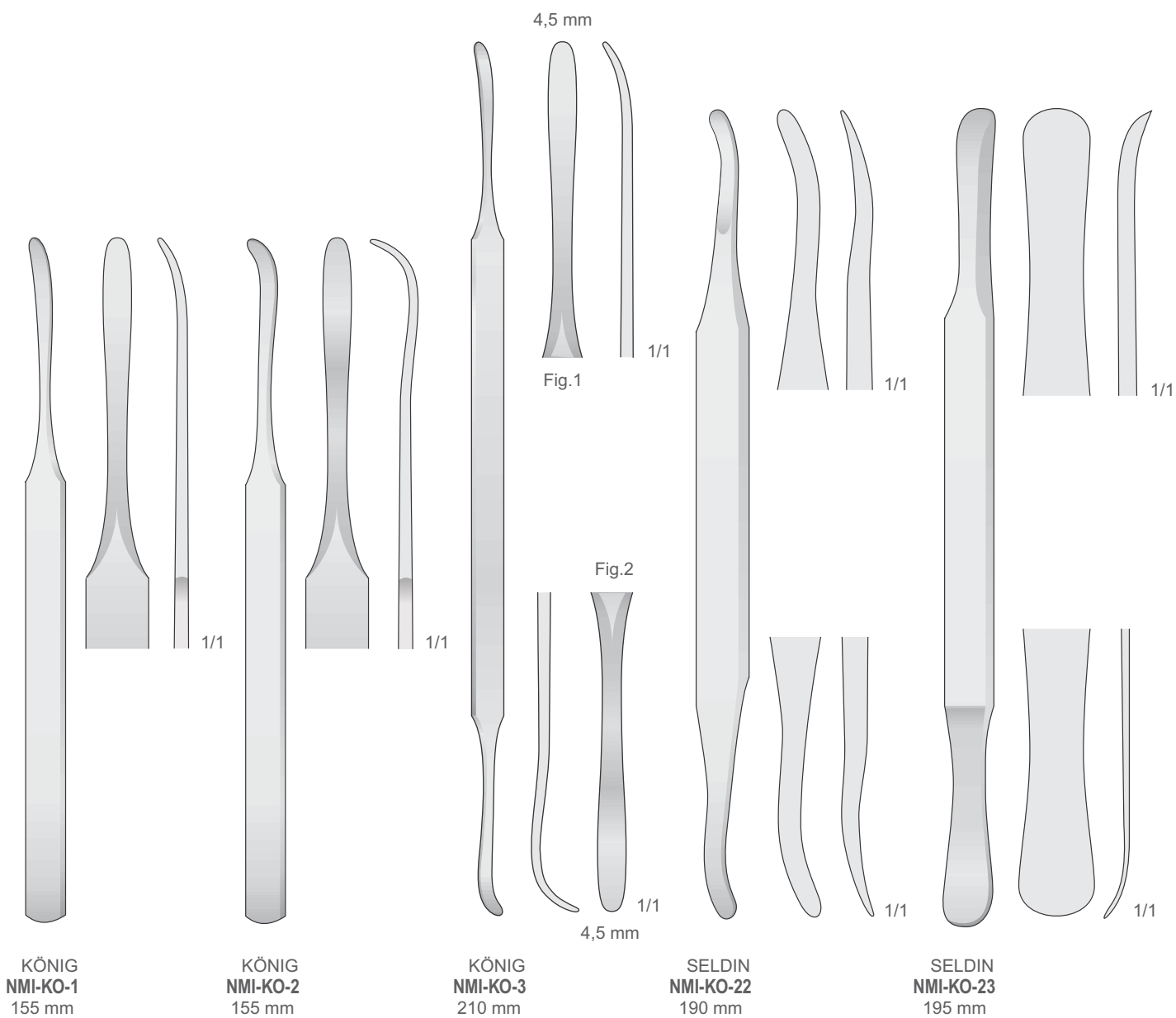
**WILLIGER**  
**NMI-WG-10**  
165 mm

**WILLIGER**  
**NMI-WG-12**  
160 mm

**WILLIGER**  
**NMI-WG-14**  
140 mm

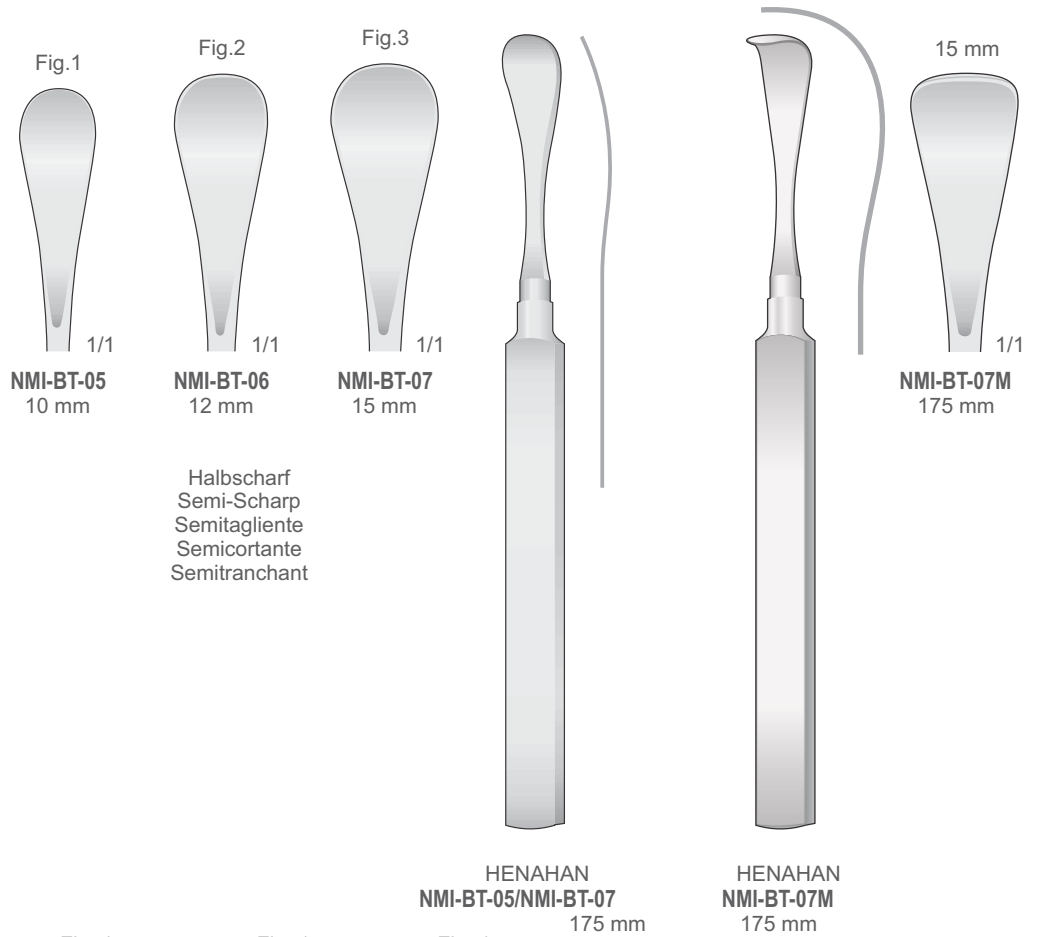


Raspatorien  
Periosteals (Raspatories)  
Scollaperiosteai (Periostotomi)  
Periostótomos (Legras)  
Rugines périostiques

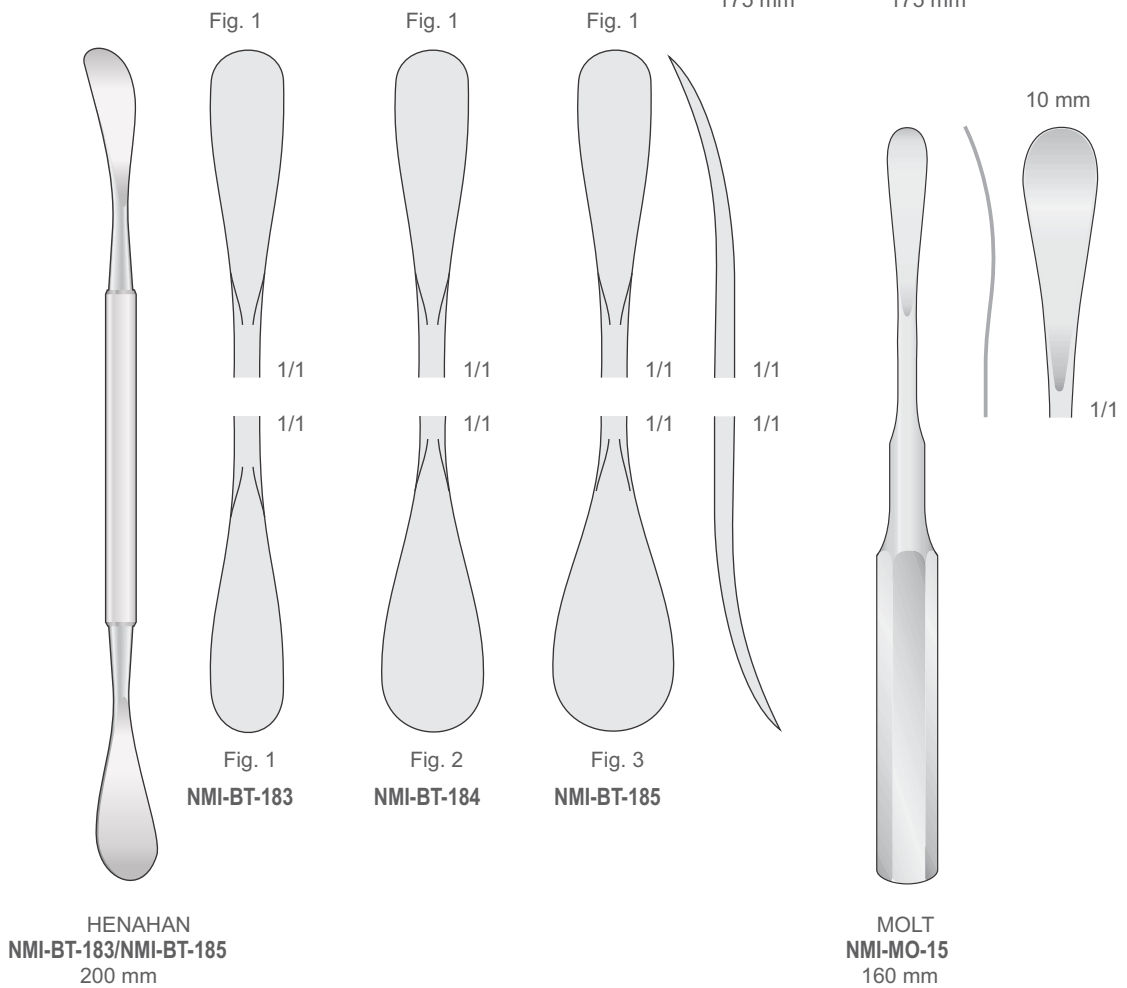




Raspatorien - Elevatorien  
Raspatories - Elevators  
Periostotomi - Elevatori  
Legras - Elevadores  
Rugines - Elevateurs



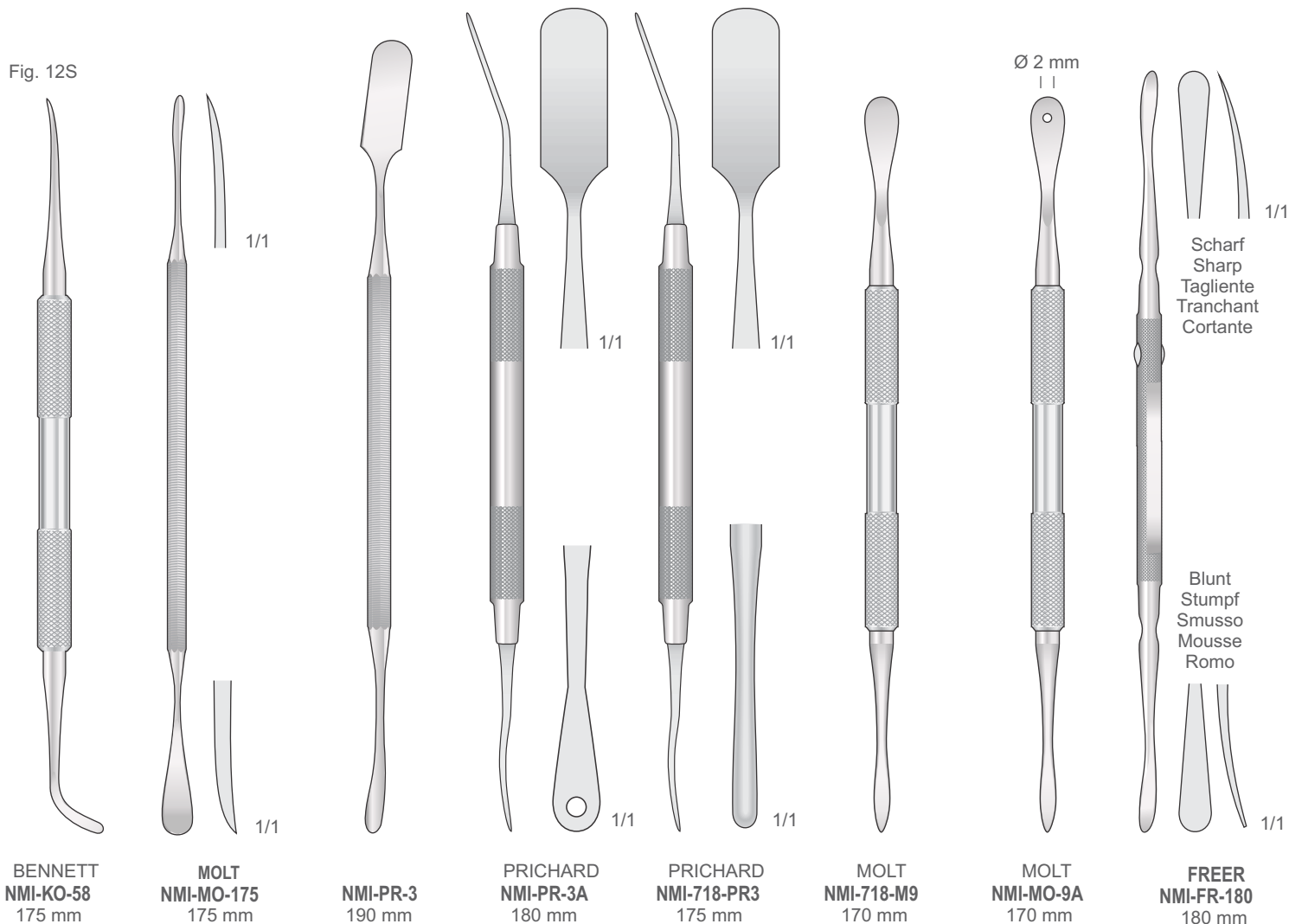
Halbscharf  
Semi-Scharp  
Semitagliente  
Semicortante  
Semitranchant





Raspatorien - Elevatorien  
Raspatories - Elevators  
Periostotomi - Elevatori  
Legras - Elevadores  
Rugines - Elevateurs

Fig. 12S



**BENNETT**  
**NMI-KO-58**  
175 mm

**MOLT**  
**NMI-MO-175**  
175 mm

**NMI-PR-3**  
190 mm

**PRICHARD**  
**NMI-PR-3A**  
180 mm

**PRICHARD**  
**NMI-718-PR3**  
175 mm

**MOLT**  
**NMI-718-M9**  
170 mm

**MOLT**  
**NMI-MO-9A**  
170 mm

**FREER**  
**NMI-FR-180**  
180 mm

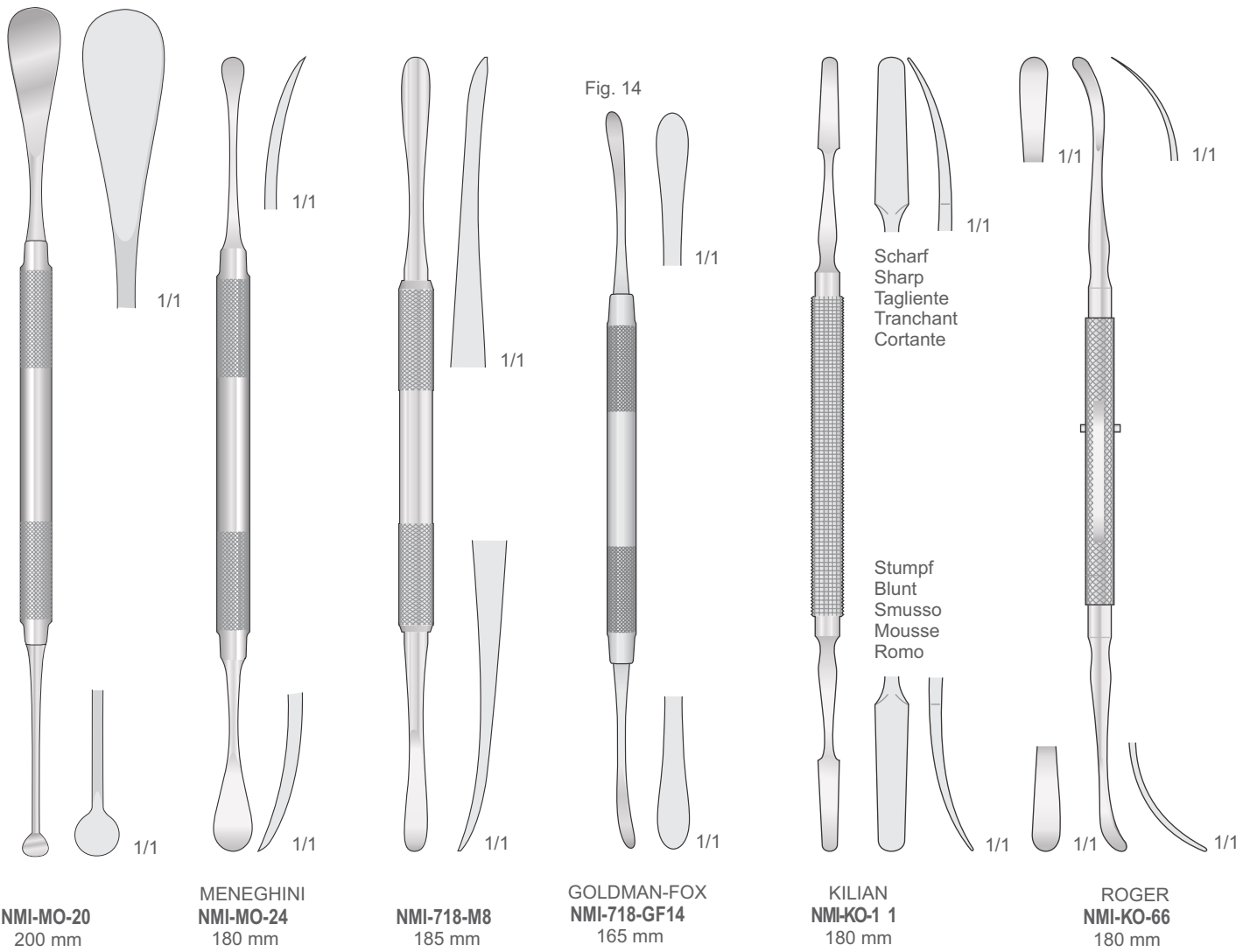
Scharf  
Sharp  
Tagliente  
Tranchant  
Cortante

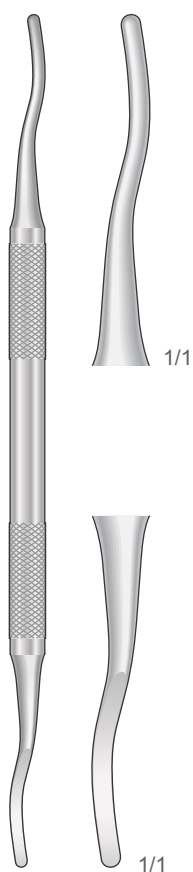
Blunt  
Stumpf  
Smusso  
Mousse  
Romo

Ø 2 mm

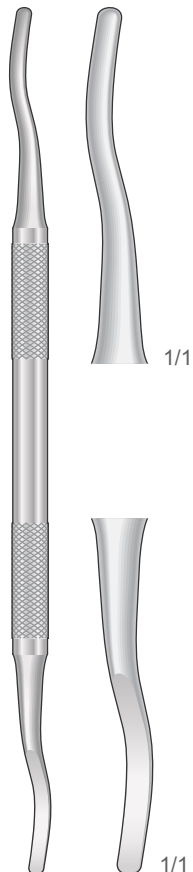


Raspatorien - Elevatorien  
Raspatories - Elevators  
Periostotomi - Elevatori  
Legras - Elevadores  
Rugines - Elevateurs

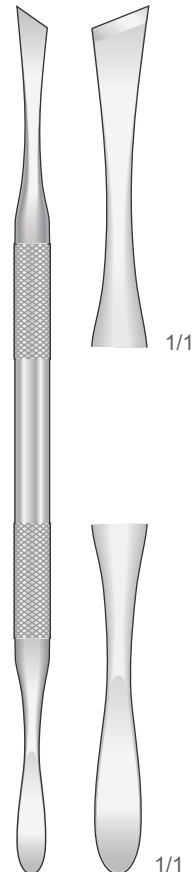




**HOPKINS**  
**NMI-718-191**  
 185 mm

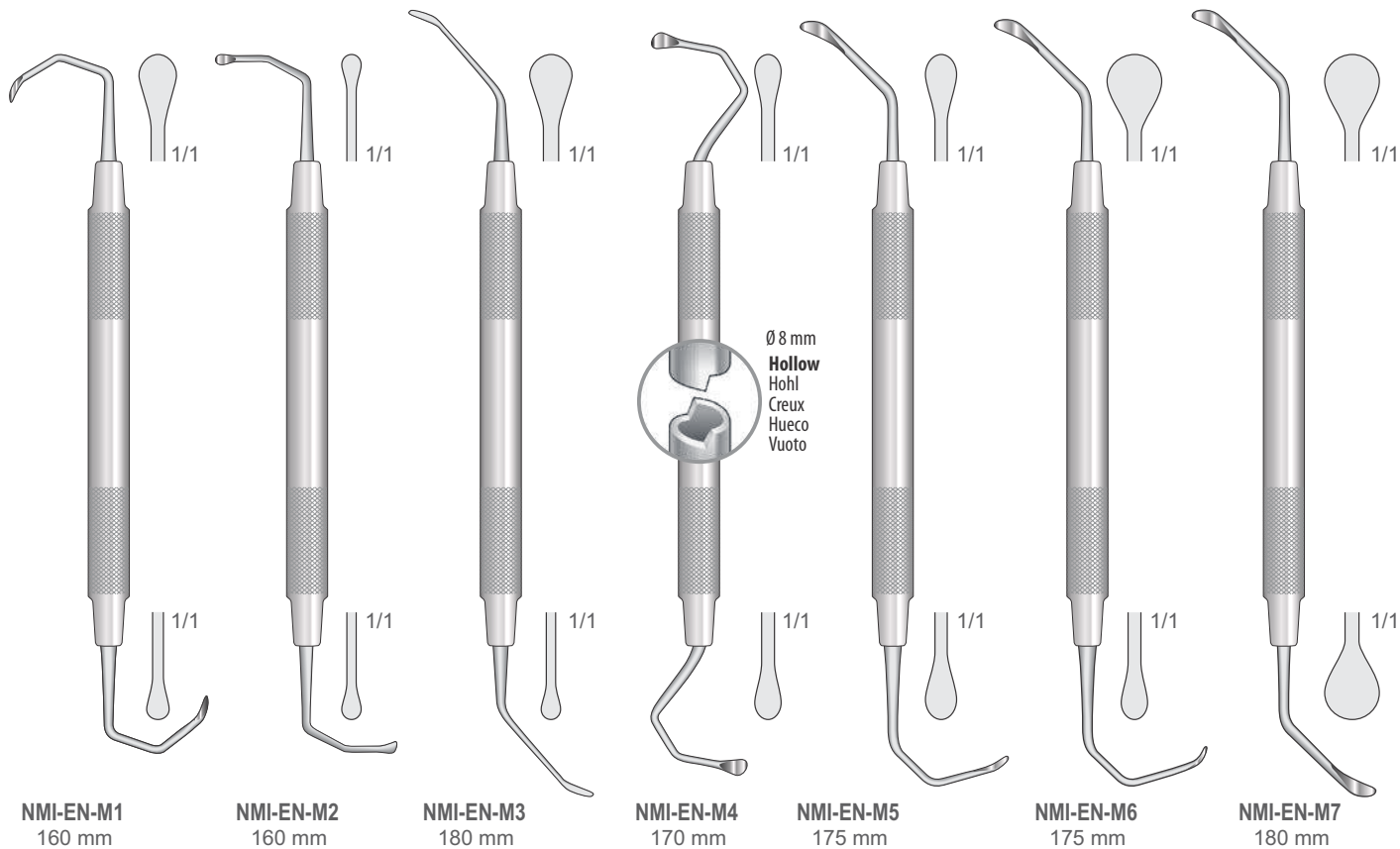


**HOPKINS**  
**NMI-718-192**  
 185 mm



**MEAD**  
**NMI-718-223**  
 185 mm

Instrumente für Sinuslift / Sinus Lift Instruments / Strumenti per rialzo del seno  
 Instrumentos para elevación de seno maxilar / Instruments d'élevation sinusienne



**NMI-EN-M1**  
 160 mm

**NMI-EN-M2**  
 160 mm

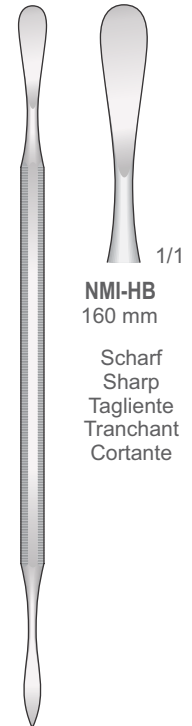
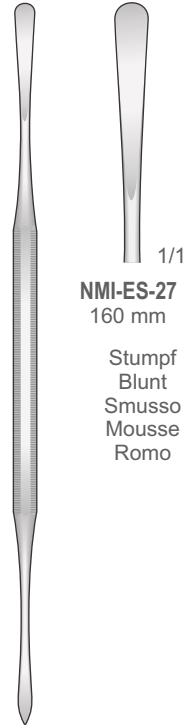
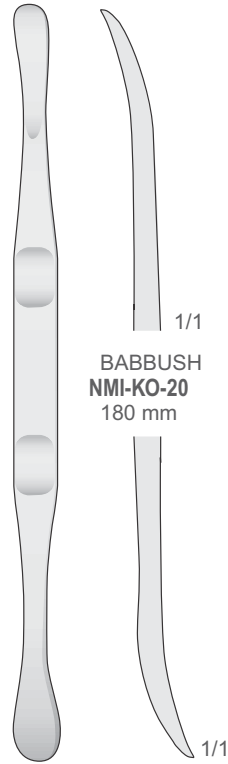
**NMI-EN-M3**  
 180 mm

**NMI-EN-M4**  
 170 mm

**NMI-EN-M5**  
 175 mm

**NMI-EN-M6**  
 175 mm

**NMI-EN-M7**  
 180 mm

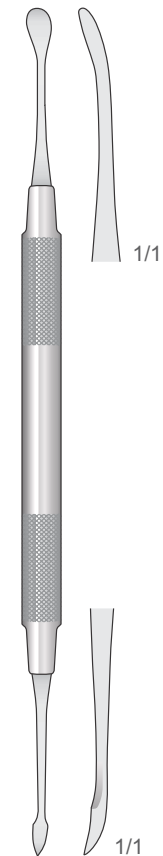


Instrumente für Sinuslift  
 Sinus Lift Instruments

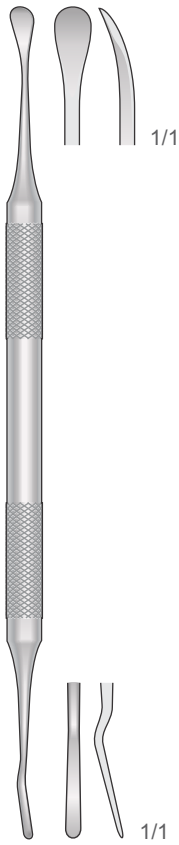
Strumenti per rialzo del seno

Instrumentos para elevación de seno maxilar  
 Instruments d'élévation sinusienne

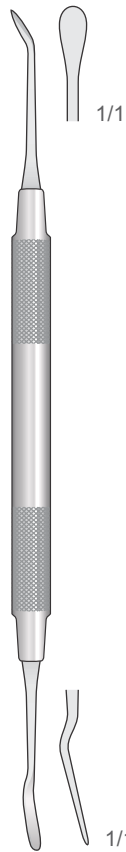
Fig. 24G



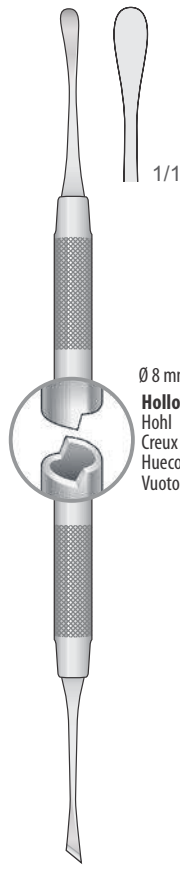
**MOLT  
NMI-MO-8**  
180 mm



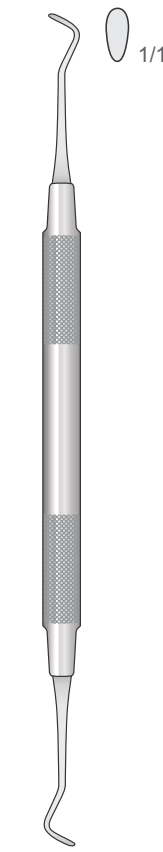
**NMI-MIR-08**  
175 mm



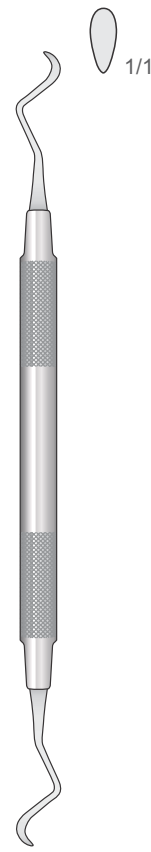
**WOODSON  
NMI-712-241**  
170 mm



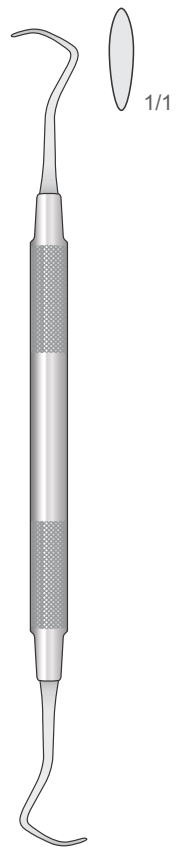
**NMI-718-24G**  
175 mm



**NMI-718-EN1**  
175 mm



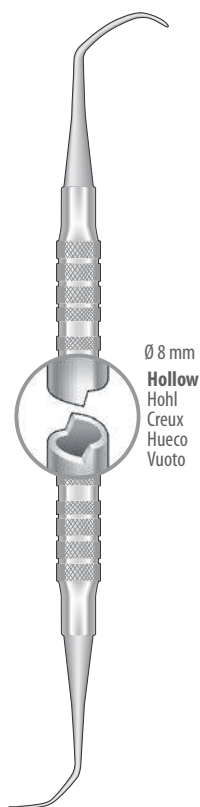
**NMI-718-EN2**  
165 mm



**NMI-718-EN3**  
170 mm

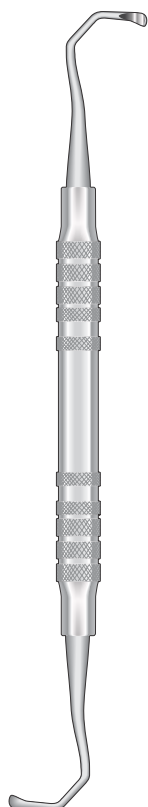


Raspatorien - Elevatorien  
Raspatories - Elevators  
Periostotomi - Elevatori  
Legras - Elevadores  
Rugines - Elevateurs

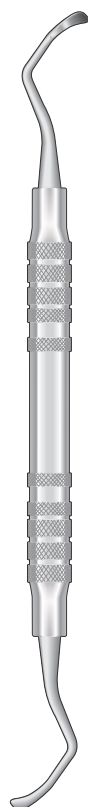


Ø 8 mm  
**Hollow**  
Hohl  
Creux  
Hueco  
Vuoto

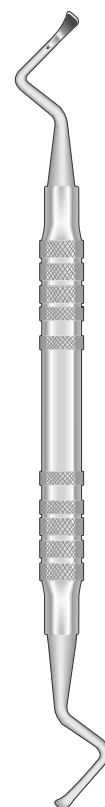
NMI-TASO-1



NMI-TASO-2



NMI-TASO-3



NMI-TASO-4



NMI-TASO-5



NMI-TASO-6



NMI-TASO-7



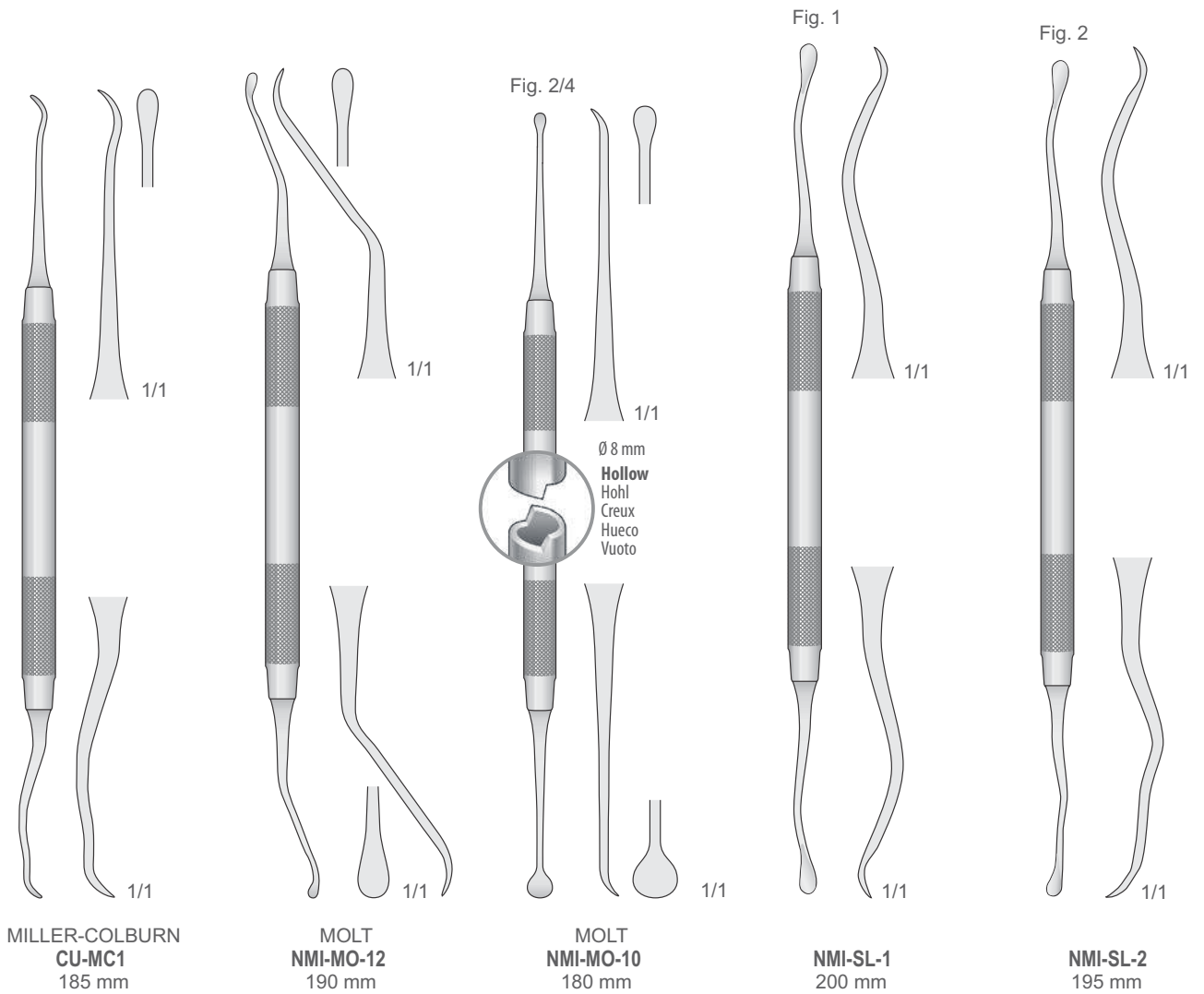
Ø 8 mm  
**Hollow**  
Hohl  
Creux  
Hueco  
Vuoto

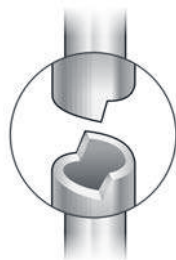
NMI-TASO-8



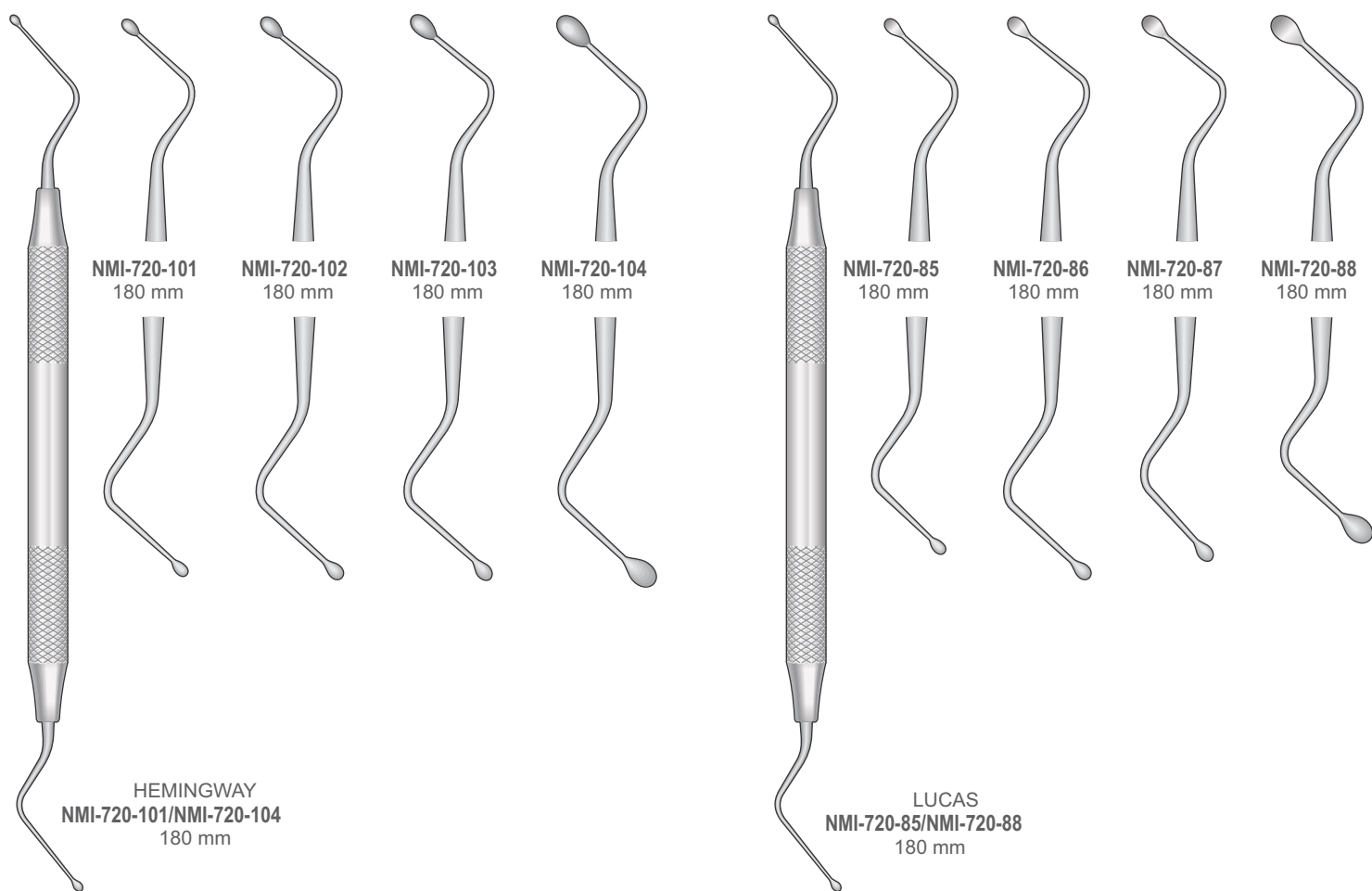
Curettes  
Küretten  
Curettes  
Curetas  
Curettes

Instrumente für Sinuslift  
Sinus Lift Instruments  
Strumenti per rialzo del seno  
Instrumentos para elevación de seno maxilar  
Instruments d'élévation sinusienne





Runder Hohlgriff 8 mm  
Hollow Round Handle 8 mm  
Manico tondo vuoto 8 mm  
Mango hueco 8 mm  
Manche rond vide 8 mm

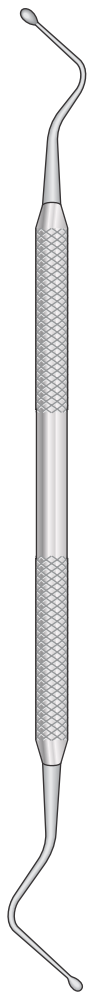


HEMINGWAY  
NMI-720-101/NMI-720-104  
180 mm

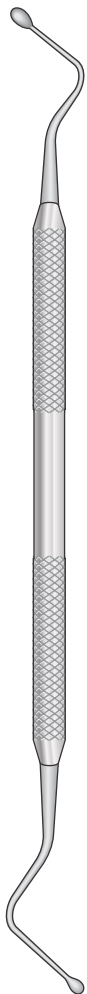
LUCAS  
NMI-720-85/NMI-720-88  
180 mm



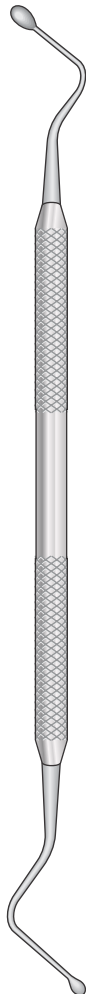
Küretten  
Curettes  
Curettes  
Curetas  
Curettes



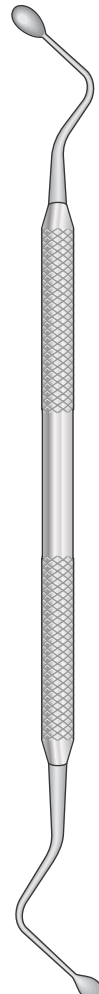
**HEMINGWAY  
NMI-C-1**  
170 mm



**HEMINGWAY  
NMI-C-2**  
170 mm

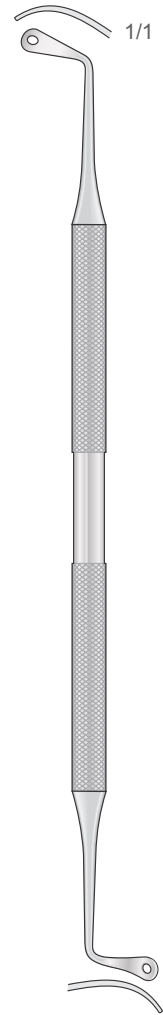


**HEMINGWAY  
NMI-C-3**  
170 mm



**HEMINGW  
NMI-C-4**  
170 mm

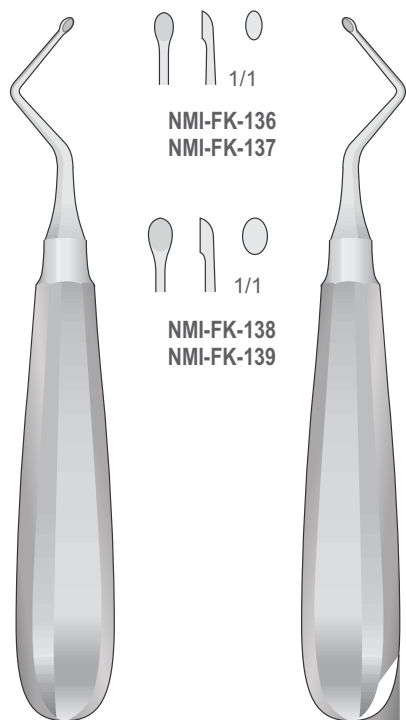
Wundhachen Mandibular  
Mandibular Nerve Diplace  
Per spostamento  
nervo mandibolare  
Para nero mandibular



**NMI-SL-21**  
165 mm



Küretten  
Curettes  
Curettes  
Curetas  
Curettes



NMI-FK-136  
NMI-FK-137

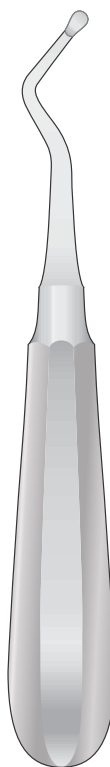
NMI-FK-138  
NMI-FK-139

KERPEL  
NMI-FK-136  
NMI-FK-138  
145 mm

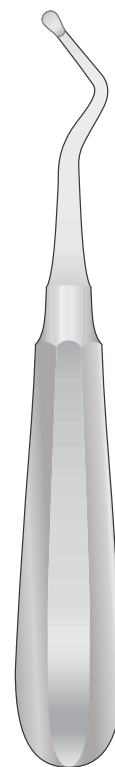
KERPEL  
NMI-FK-137  
NMI-FK-139  
145 mm



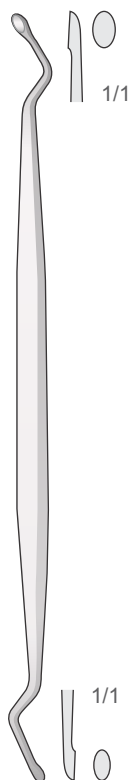
NMI-DL-50  
155 mm



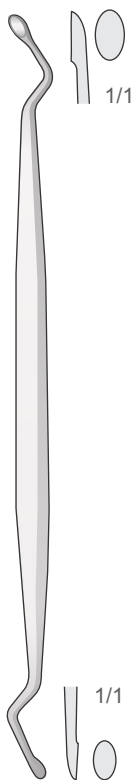
NMI-DL-51  
150 mm



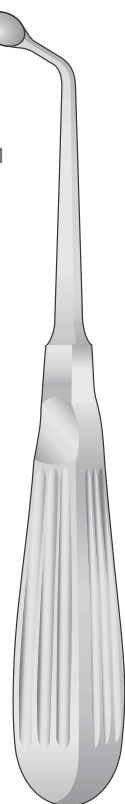
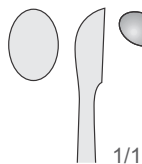
NMI-DL-52  
150 mm



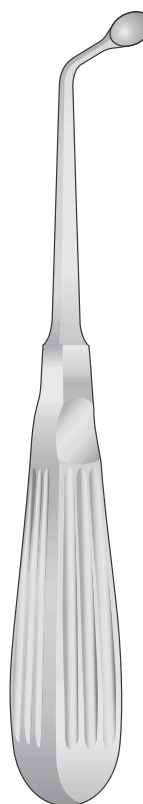
NMI-FK-83  
160 mm



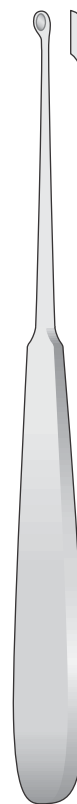
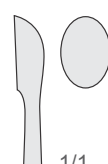
JANSEN  
NMI-FK-84  
160 mm



UFFENDORDE  
NMI-FK-188  
170 mm



UFFENDORDE  
NMI-FK-189  
170 mm



WILLIGER  
NMI-FK-197/NMI-FK-198  
170 mm

Fig. 00  
3,4 mm



1/1 NMI-FK-197

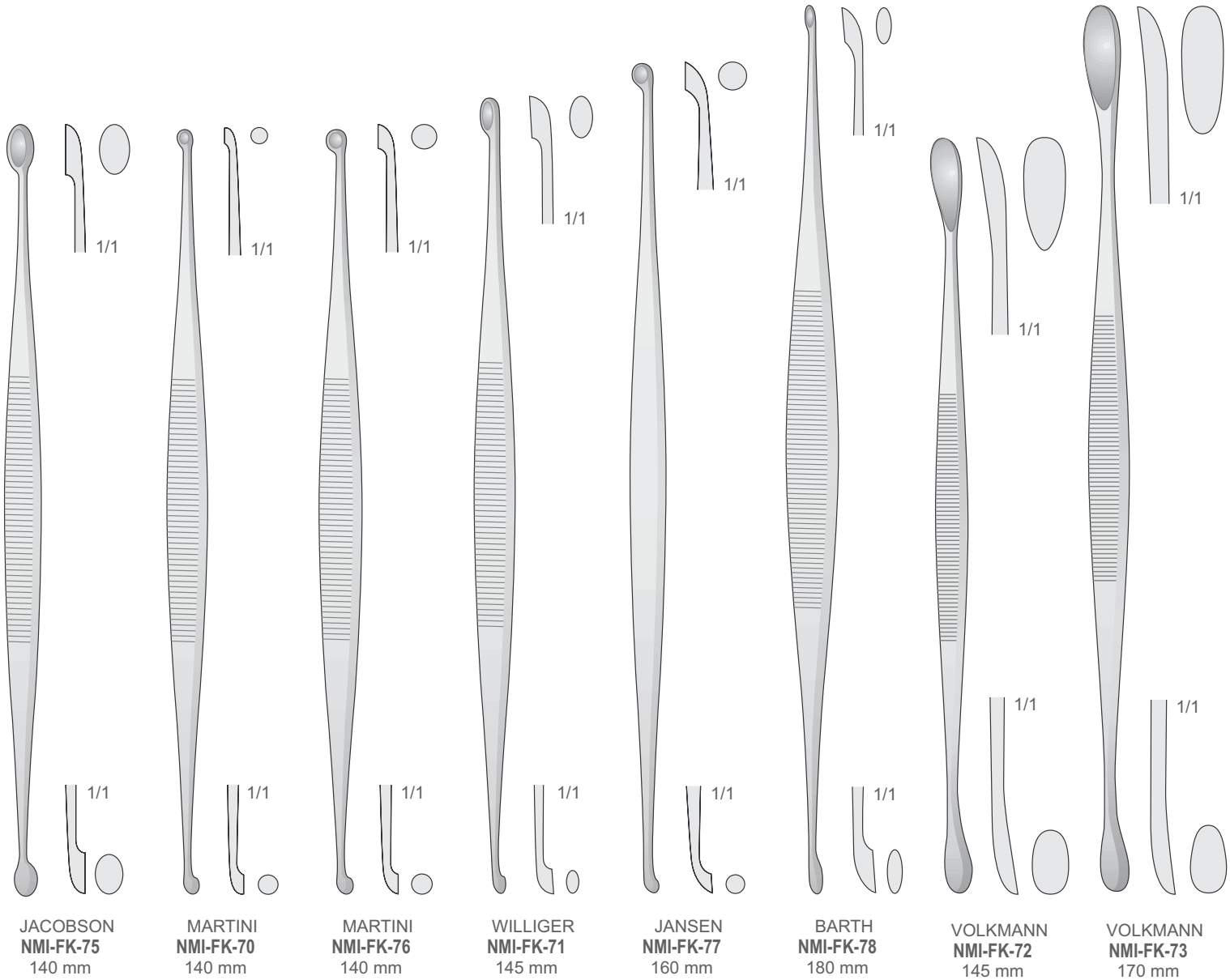
Fig. 1  
5,2 mm



1/1 NMI-FK-198

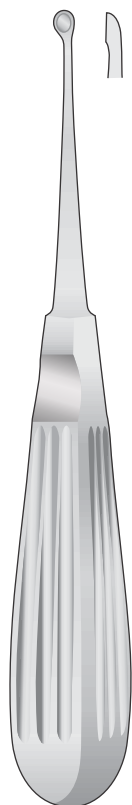


Küretten  
Curettes  
Curettes  
Curetas  
Curettes

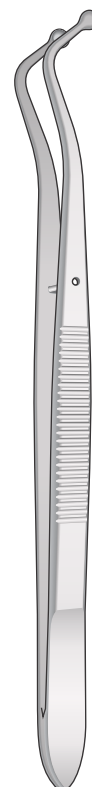




Küretten  
Curettes  
Curettes  
Curetas  
Curettes

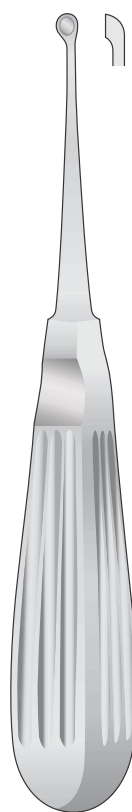


- |  |                                       |                                      |                                      |
|--|---------------------------------------|--------------------------------------|--------------------------------------|
| Fig.0000<br>2,8 mm<br>1/1<br>NMI-FK-60 | Fig.000<br>3,6 mm<br>1/1<br>NMI-FK-61 | Fig.00<br>4,4 mm<br>1/1<br>NMI-FK-62 | ,Fig.0<br>5,2 mm<br>1/1<br>NMI-FK-63 |
| Fig.1<br>6,8 mm<br>1/1<br>NMI-FK-64    | Fig.2<br>8,5 mm<br>1/1<br>NMI-FK-65   | Fig.3<br>10 mm<br>1/1<br>NMI-FK-66   | Fig.4<br>11,5 mm<br>1/1<br>NMI-FK-67 |

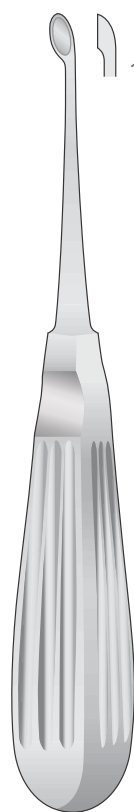


VOLKMAN  
NMI-FK-60/NMI-FK-67  
170 mm

COLLEGE CURETTE  
NMI-MIR-10  
160 mm



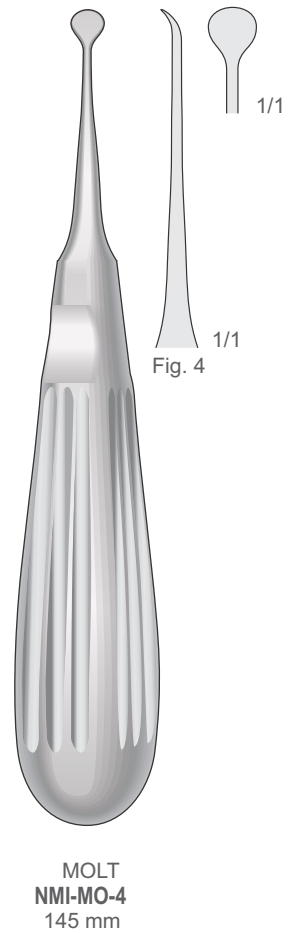
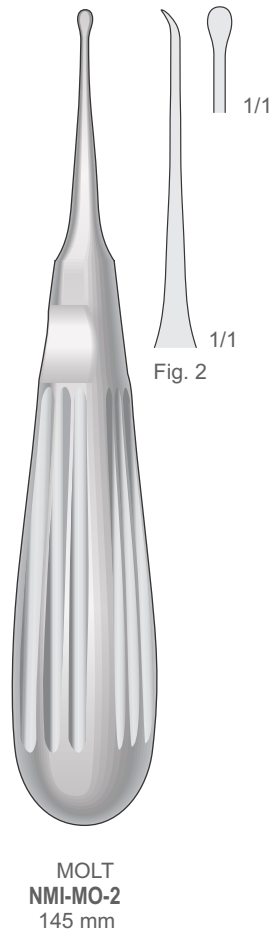
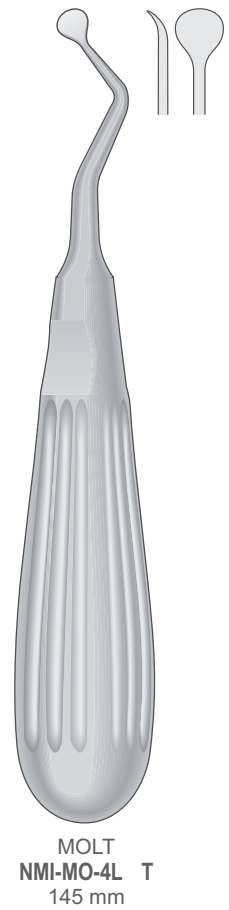
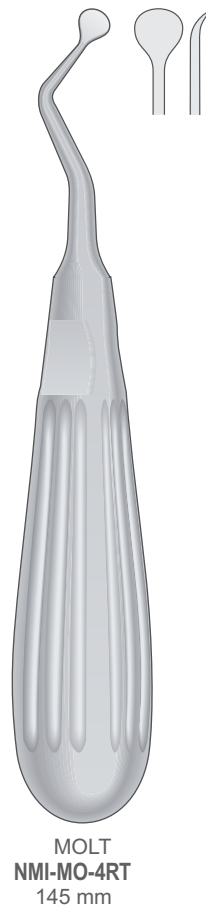
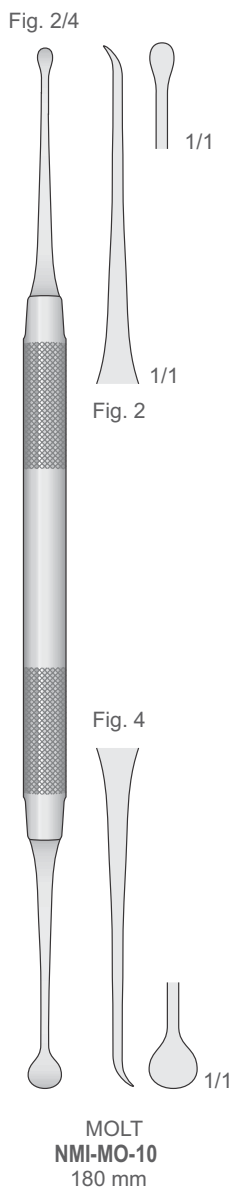
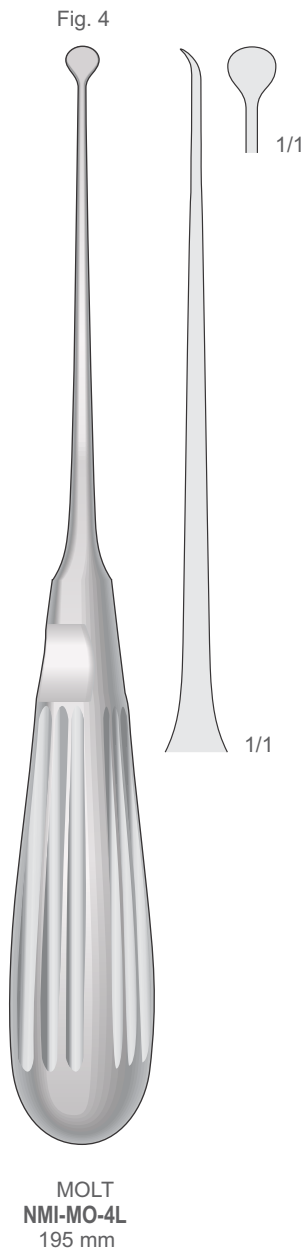
- |                             |                            |                             |
|-----------------------------|----------------------------|-----------------------------|
| 3 mm<br>1/1<br>NMI-FK-1 10  | 4 mm<br>1/1<br>NMI-FK-1 11 | 5 mm<br>1/1<br>NMI-FK-1 12  |
| 6 mm<br>1/1<br>NMI-FK-1 13  | 8 mm<br>1/1<br>NMI-FK-1 14 | 12 mm<br>1/1<br>NMI-FK-1 16 |
| 10 mm<br>1/1<br>NMI-FK-1 15 |                            |                             |



- |                             |                             |                             |
|-----------------------------|-----------------------------|-----------------------------|
| 2,5 mm<br>1/1<br>NMI-FK-120 | 3,4 mm<br>1/1<br>NMI-FK-121 | 4,2 mm<br>1/1<br>NMI-FK-122 |
| 5,2 mm<br>1/1<br>NMI-FK-123 |                             | 6,3 mm<br>1/1<br>NMI-FK-124 |
| 7,4 mm<br>1/1<br>NMI-FK-125 |                             | 8 mm<br>1/1<br>NMI-FK-126   |

BRUNS  
NMI-FK-1 10/NMI-FK-1 16  
165 mm

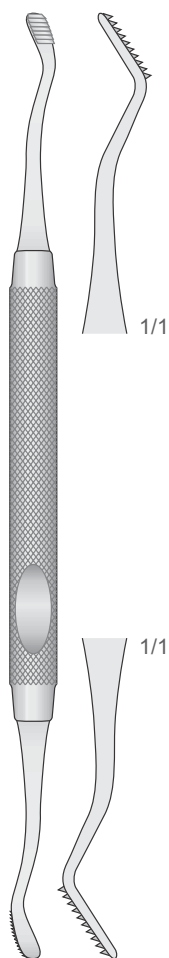
SCHEDÉ  
NMI-FK-120/NMI-FK-126  
170 mm





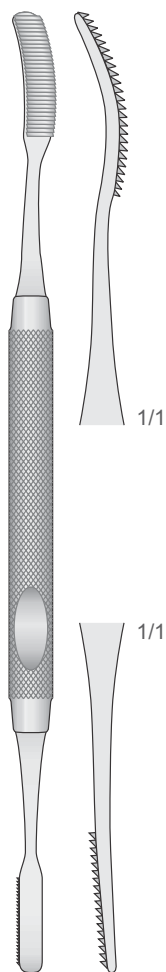
Knochenfeilen  
Bone Files  
Lime per osso  
Limas para hueso  
Limes à os

Fig. 67



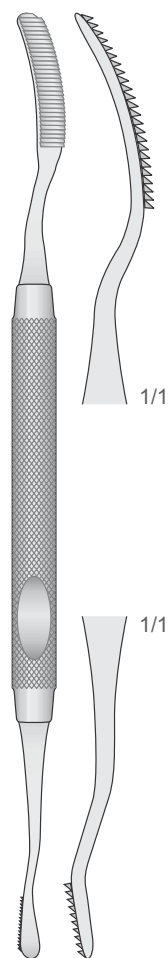
**HOWARD  
NMI-DO-1**  
180 mm

Fig. 45



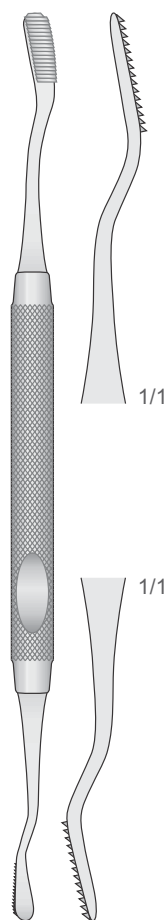
**MILLER  
NMI-DO-2**  
185 mm

Fig. 52



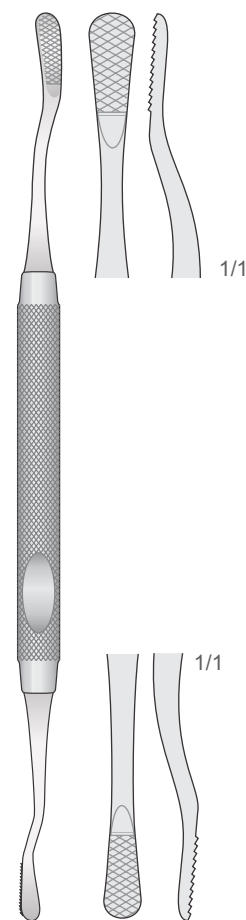
**MILLER  
NMI-DO-3**  
180 mm

Fig. 12



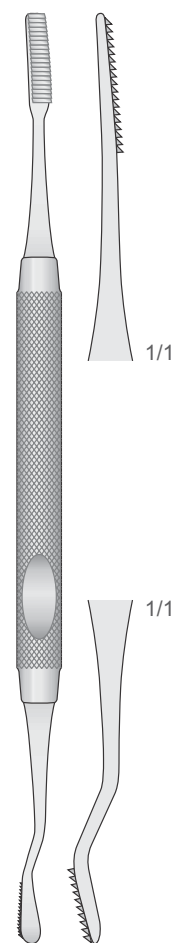
**HOWARD  
NMI-DO-4**  
170 mm

Fig. 12A



**MILLER  
NMI-DO-4C**  
170 mm

Fig. 64

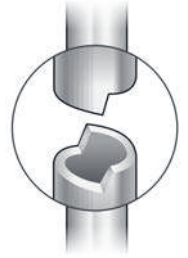


**MILLER  
NMI-DO-5**  
175 mm

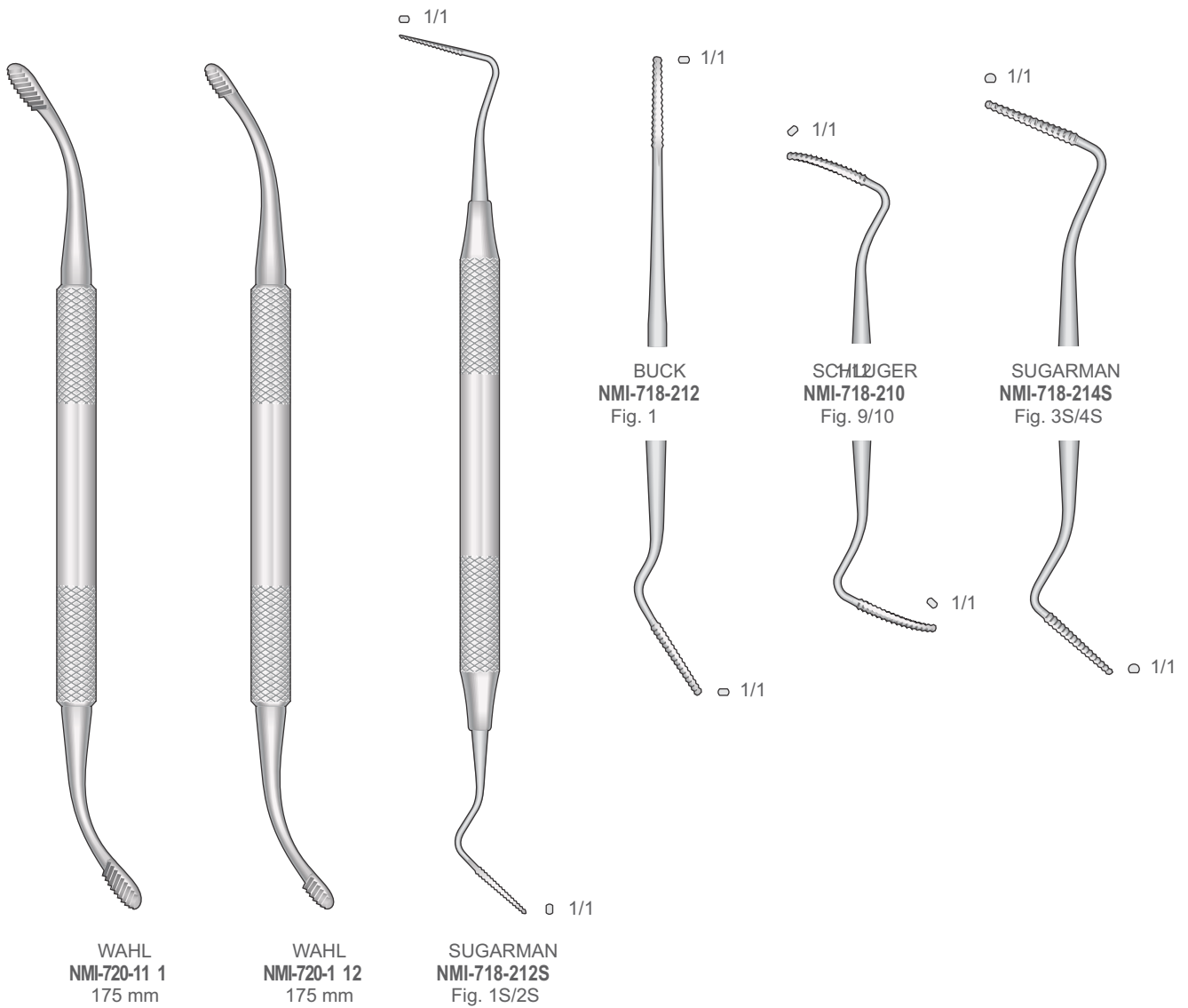
Knochenfeilen  
Bone Files  
Lime per osso  
Limas para hueso  
Limes à os



Runder Hohlgriff 8 mm  
Hollow Round Handle 8 mm  
Manico tondo vuoto 8 mm  
Mango hueco 8 mm  
Manche rond vide 8 mm

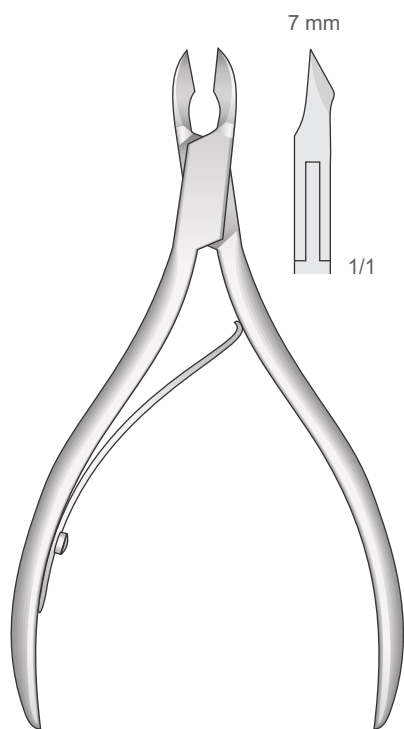


Parodontal Feilen  
Periodontal Files  
Lime parodontali  
Limas periodontales  
Limes parodontales

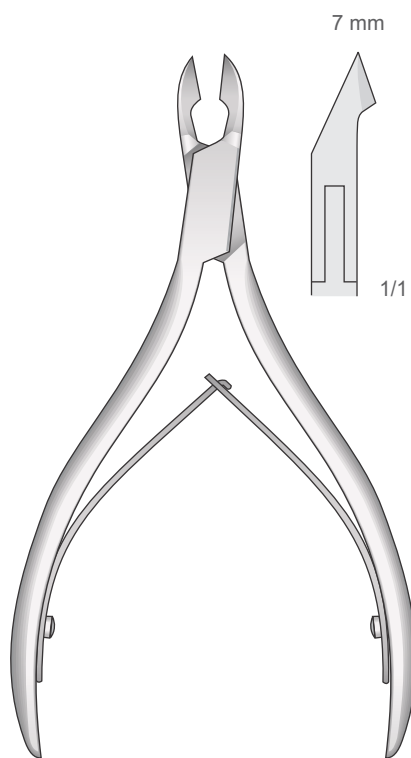




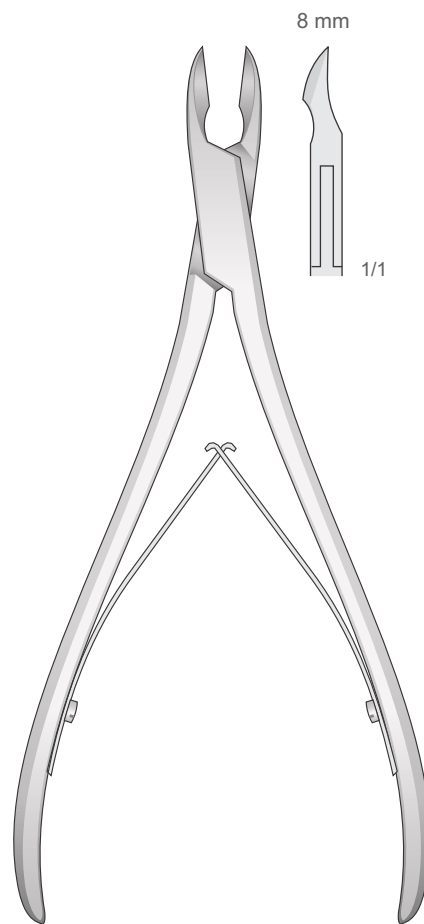
Gewebezängchen  
Tissue Nippers  
Tronchesi per gengive e tessuti  
Pinzas para cortar tejidos  
Pincas coupante pour tissue



CHOEN  
NMI-LX-60  
105 mm



ILIC  
NMI-LX-50  
15 mm  
1

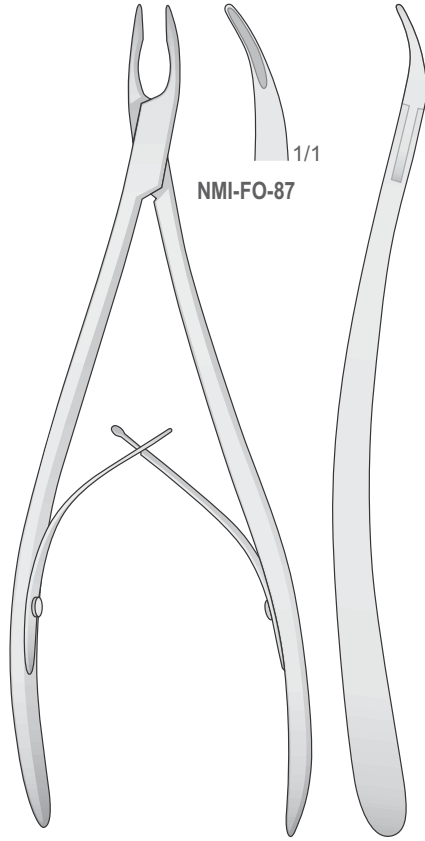


NMI-LX-52  
140 mm



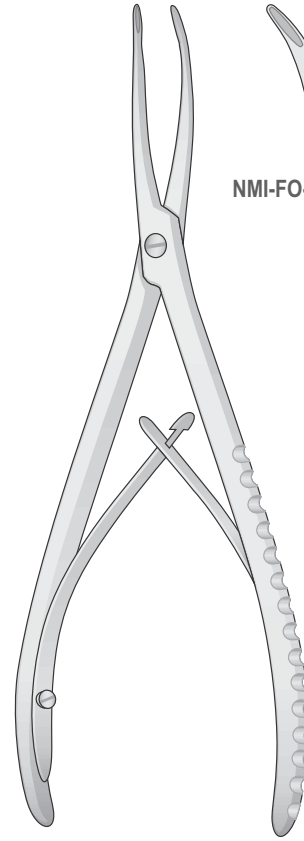
Hohlmeißelzangen  
Bone rongeurs  
Pinze ossivore  
Pinzas gubias  
Pincas gouges

S-Form



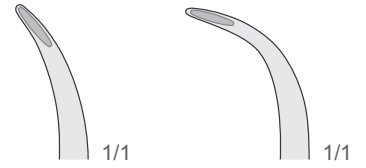
NMI-FO-87

STELLBRINK  
NMI-FO-87  
190 mm

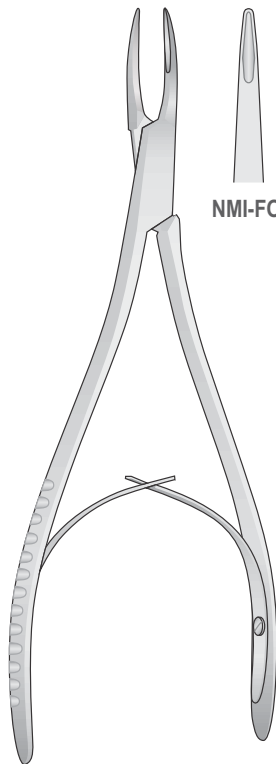


NMI-FO-88

STELLBRINK  
NMI-FO-88/NMI-FO-89  
170 mm

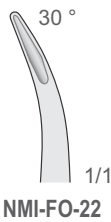


NMI-FO-89

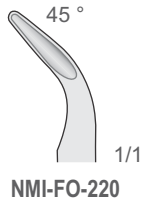


NMI-FO-23

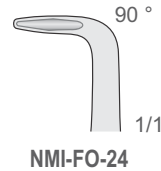
MINI-FRIEDMANN  
NMI-FO-22/NMI-FO-220  
150 mm



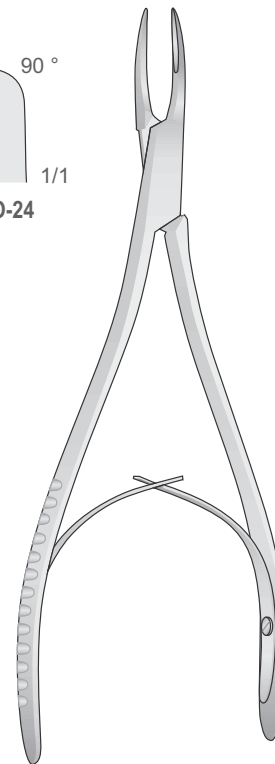
NMI-FO-22



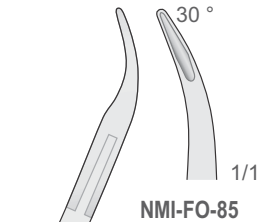
NMI-FO-220



NMI-FO-24



MINI-FRIEDMANN  
NMI-FO-85  
145 mm

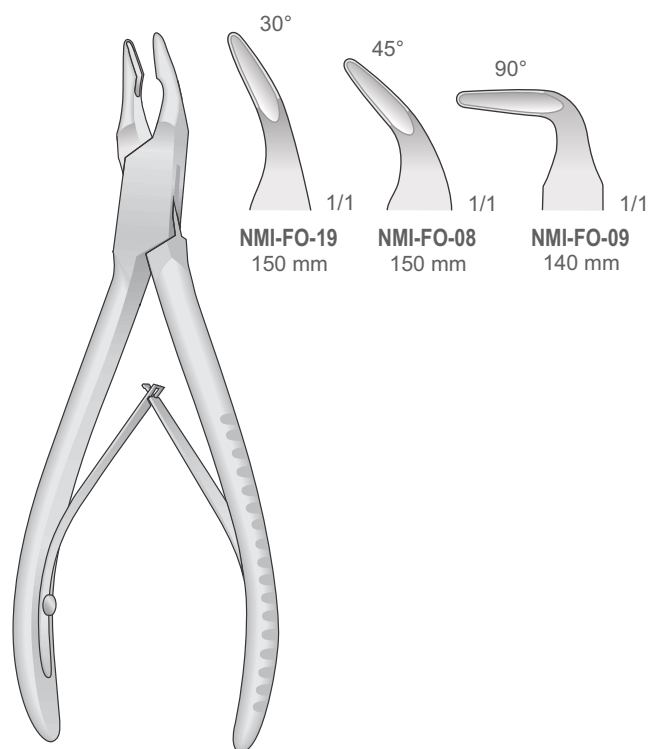


NMI-FO-85

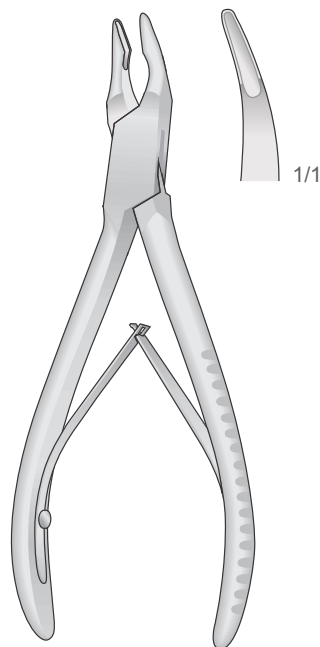
S-Form



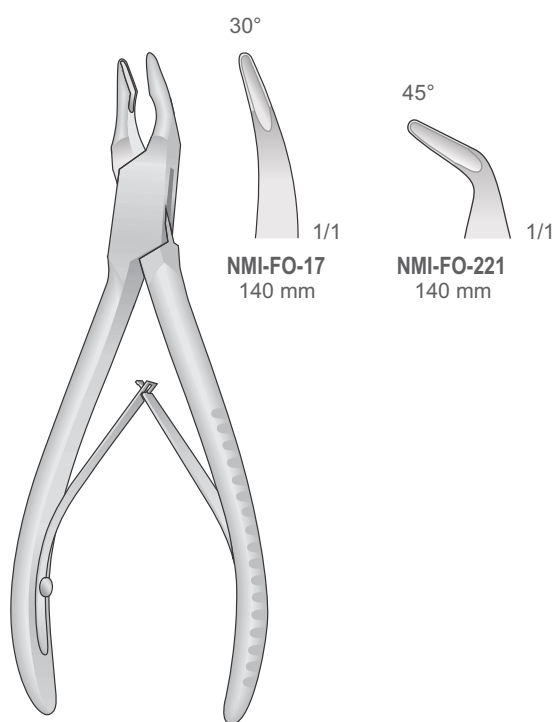
Hohlmeißelzangen  
Bone rongeurs  
Pinze ossivore  
Pinzas gubias  
Pinces gouges



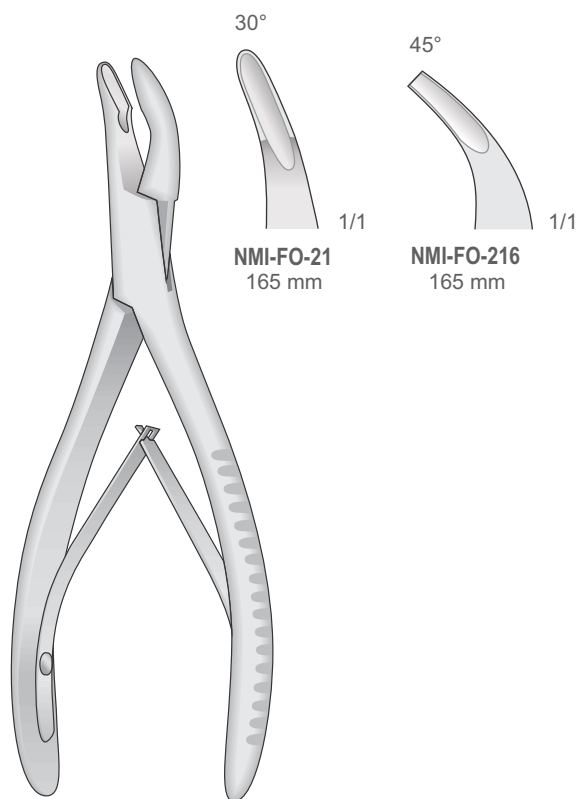
**BLUMENTHAL**  
NMI-FO-08/NMI-FO-19



**MINI FRIEDMAN**  
NMI-FO-15  
120 mm



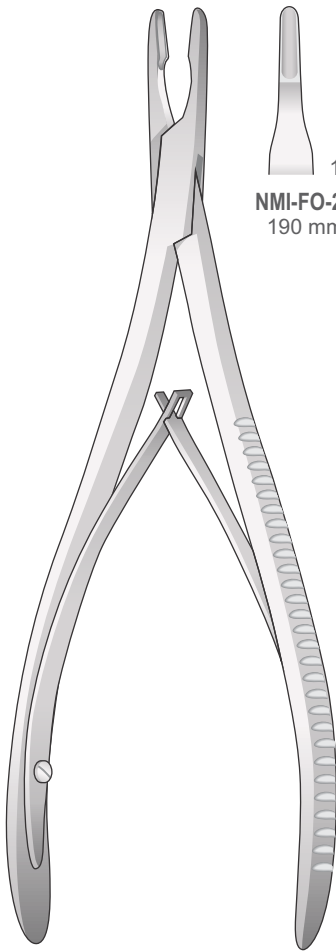
**FRIEDMANN**  
NMI-FO-17/NMI-FO-221  
140 mm



**MEAD**  
NMI-FO-21/NMI-FO-216  
165 mm

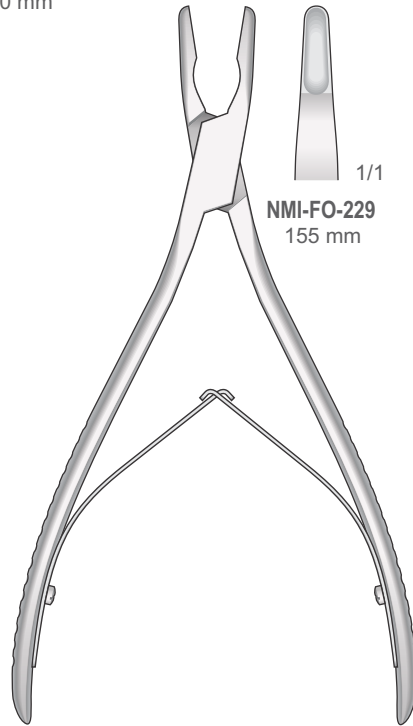


Hohlmeißelzangen  
Bone rongeurs  
Pinze ossivore  
Pinzas gubias  
Pincas gouges



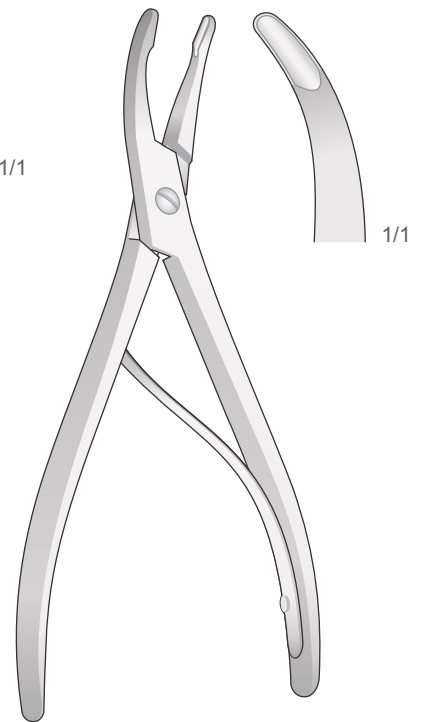
**NMI-FO-25**  
190 mm

**NMI-FO-43**  
190 mm



**NMI-FO-229**  
155 mm

**NMI-FO-230**  
155 mm



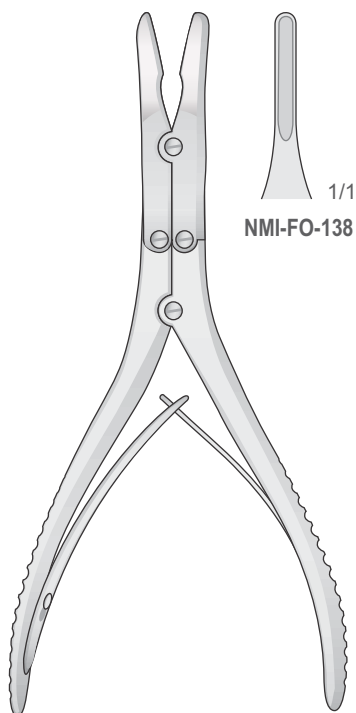
**LUER**  
**NMI-FO-18**  
155 mm

**LEMPERT**  
**NMI-FO-25/NMI-FO-43**  
190 mm

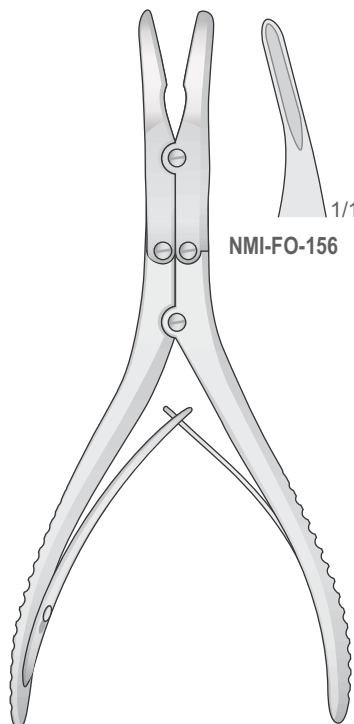
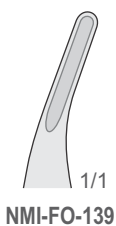
**LEMPERT**  
**NMI-FO-229/NMI-FO-230**  
155 mm



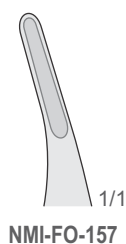
Hohlmeißelzangen  
Bone rongeurs  
Pinze ossivore  
Pinzas gubias  
Pinces gouges



1/1  
NMI-FO-138

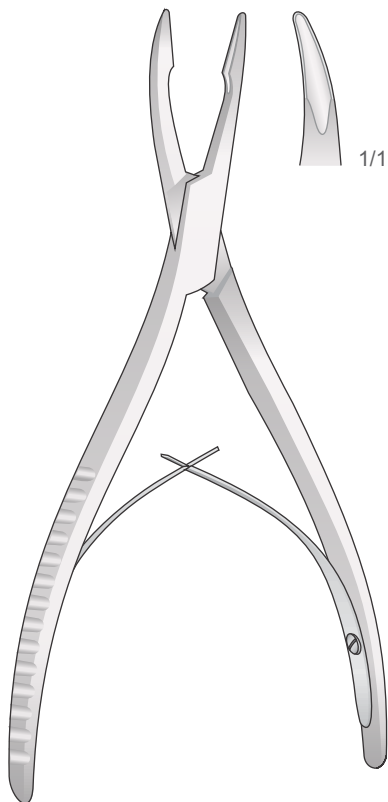


1/1  
NMI-FO-156

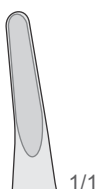
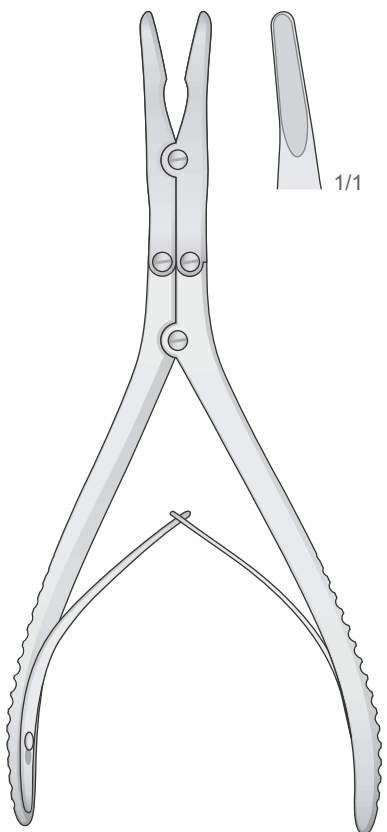


RUSKIN  
NMI-FO-138/NMI-FO-139  
150 mm

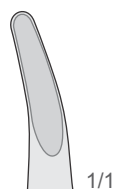
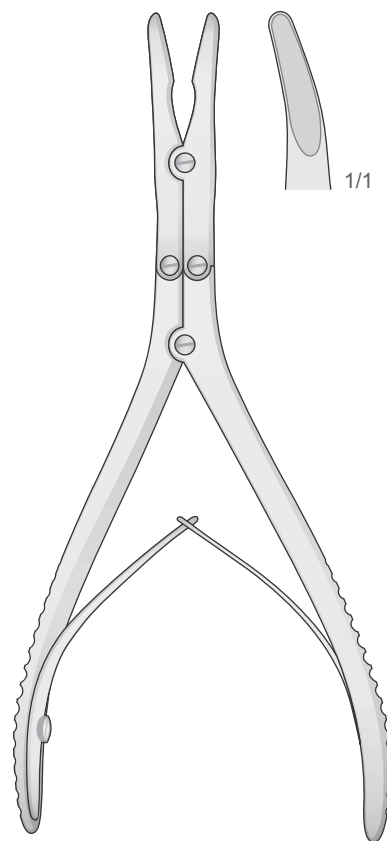
KLEINERT-KUTZ  
NMI-FO-156/NMI-FO-157  
155 mm



FRIEDMANN  
NMI-FO-16  
160 mm



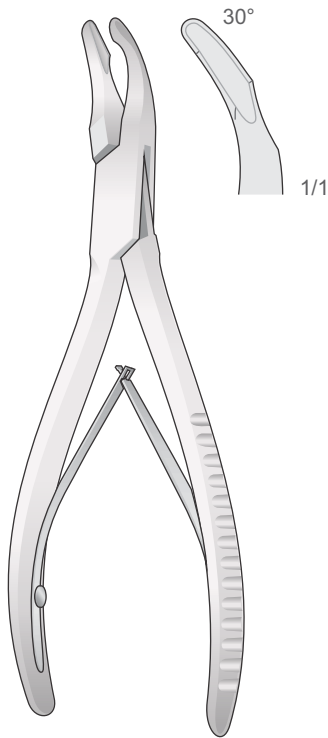
BEYER  
NMI-FO-20  
180 mm



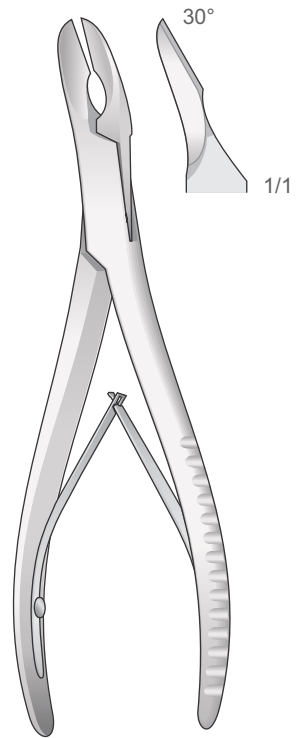
ZAUFAL-JANSEN  
NMI-FO-34  
180 mm



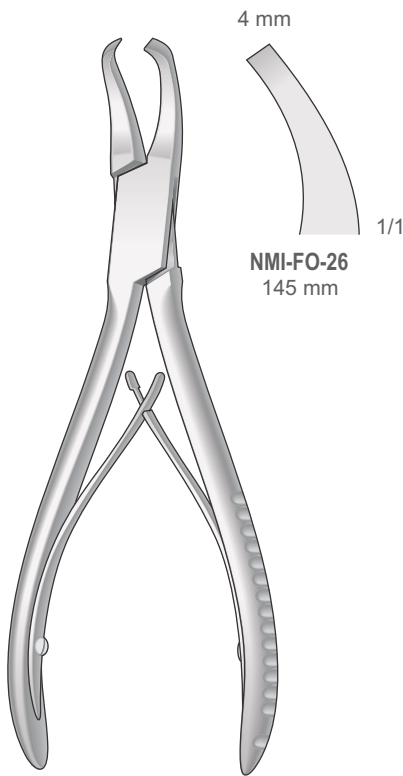
Hohlmeißelzangen  
Bone rongeurs  
Pinze ossivore  
Pinzas gubias  
Pincas gouges



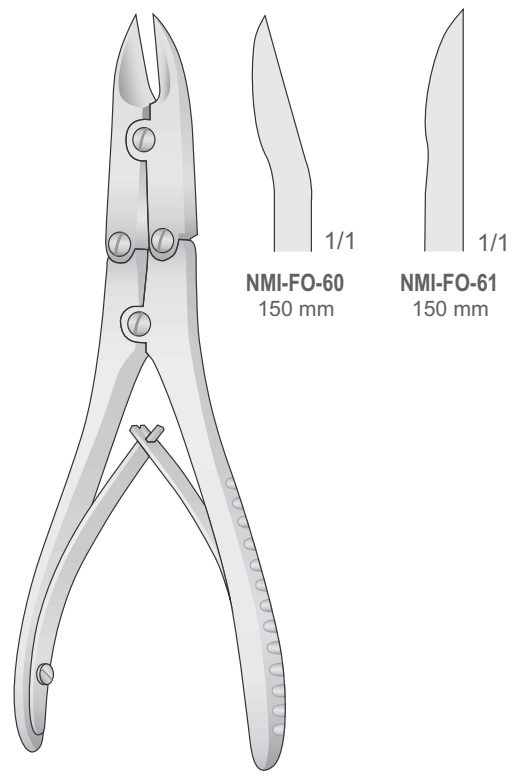
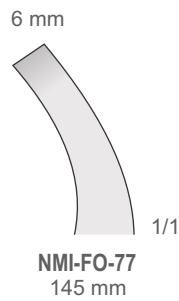
CLEVELAND  
NMI-FO-231 140 mm  
NMI-FO-232 170 mm



CLEVELAND  
NMI-FO-233 150 mm  
NMI-FO-234 170 mm



GARDNER  
NMI-FO-26/NMI-FO-77  
145 mm



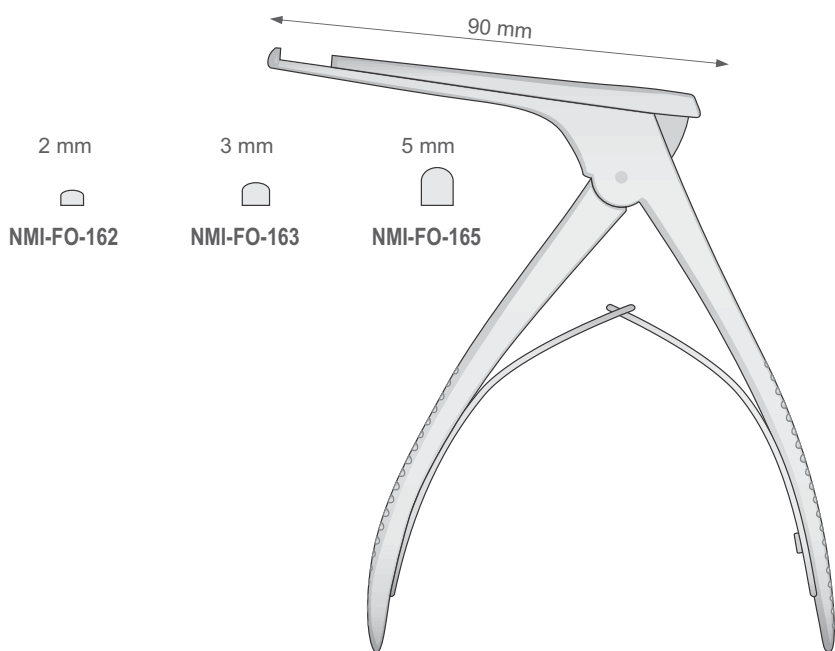
BÖHLER  
NMI-FO-60/NMI-FO-61  
150 mm



Knochensplitterzangen  
Bone cutting forceps  
Pinze ossivore  
Pinzas cortantes para huesos  
Pincas coupantes à os

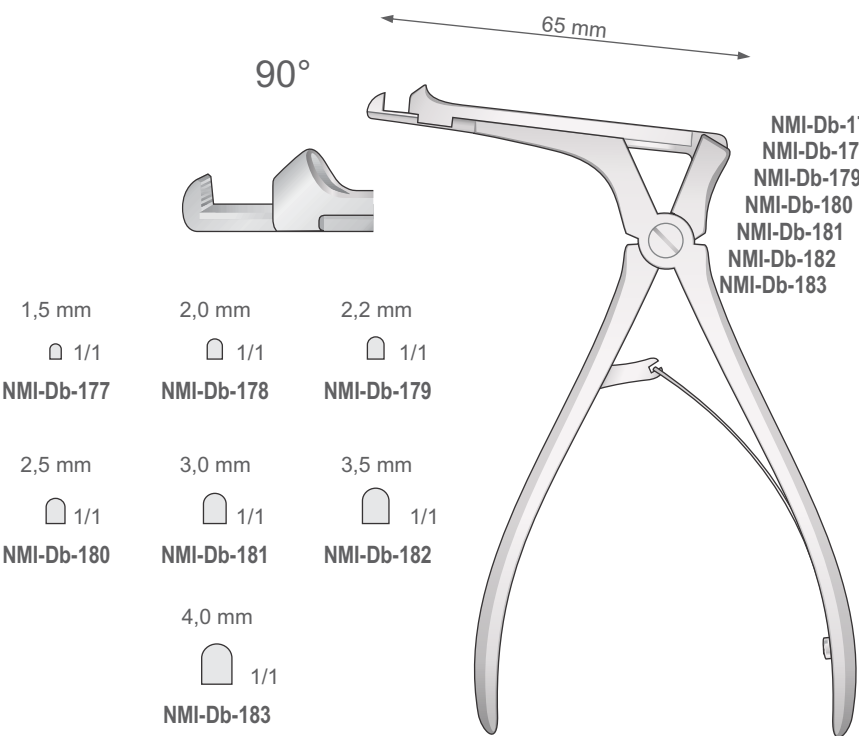
Punches - Stanzen

Bone cutting forceps  
for opening the Sinus  
Strumento tagliente per  
aumentare il volume del seno



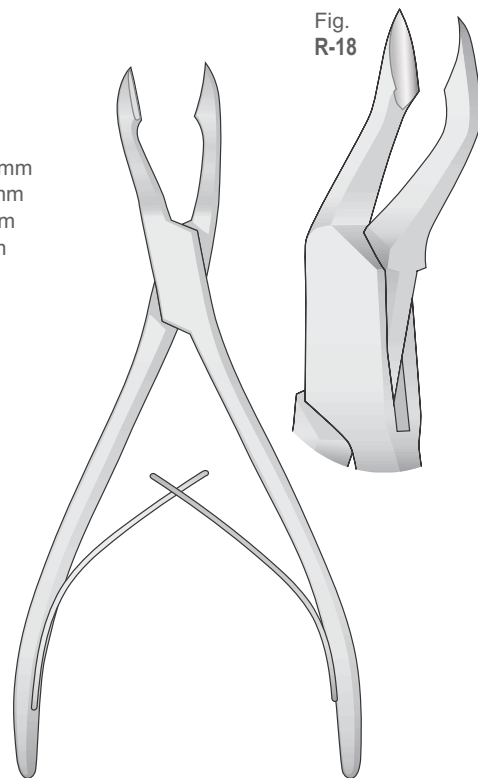
KERRISON  
NMI-FO-162 2 mm  
NMI-FO-163 3 mm  
NMI-FO-165 5 mm

Bone cutting forceps  
for opening the Sinus  
Strumento tagliente per  
aumentare il volume del seno



CITELLI  
NMI-Db-177/NMI-Db-183

Fig.  
R-18



NMI-FO-33  
175 mm

# DENTAL Instruments

Extracting Forceps

Root Elevators

Scalpel Blades and Handles

Surgical Scissors

Tissue and Dressing Forceps

Needle Holders

Hemostatic Forceps | Towel Clamps

Retractors | Mouth Gags

Implantology

Periosteal | Curettes | Rongeurs

Dental Restoration | Periodontology

Suction Tube

Orthodontics

Crown Instruments | Laboratory

Instrument Maintenance | Sterilization



**239-303**

**Periodontology**

Parodontologie

Parodontie

Periodoncia

Parodontologia

**Diagnosis**

Diagnose

Diagnostic

Diagnóstico

Diagnosi

**Dental Restoration**

Restaurative Zahnheilkunde

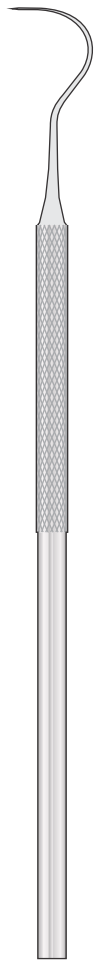
Odontologie conservatrice

Odontología conservadora

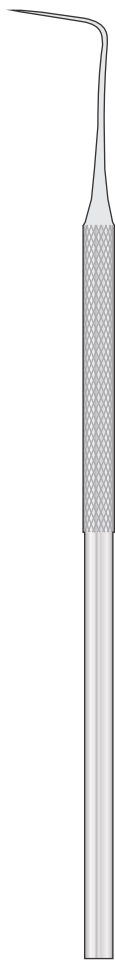
Odontoiatria conservativa



Zahnsonden  
Explorers - Sickle Probes  
Esploratori - Sonde falce  
Sondas exploradoras  
Sondes exploratrices



**NMI-SO-1**  
Fig. 23



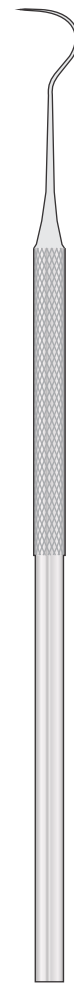
**NMI-SO-2**  
Fig. 1



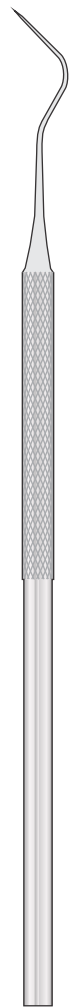
**NMI-SO-3**  
Fig. 6



**NMI-SO-4**  
Fig. 9



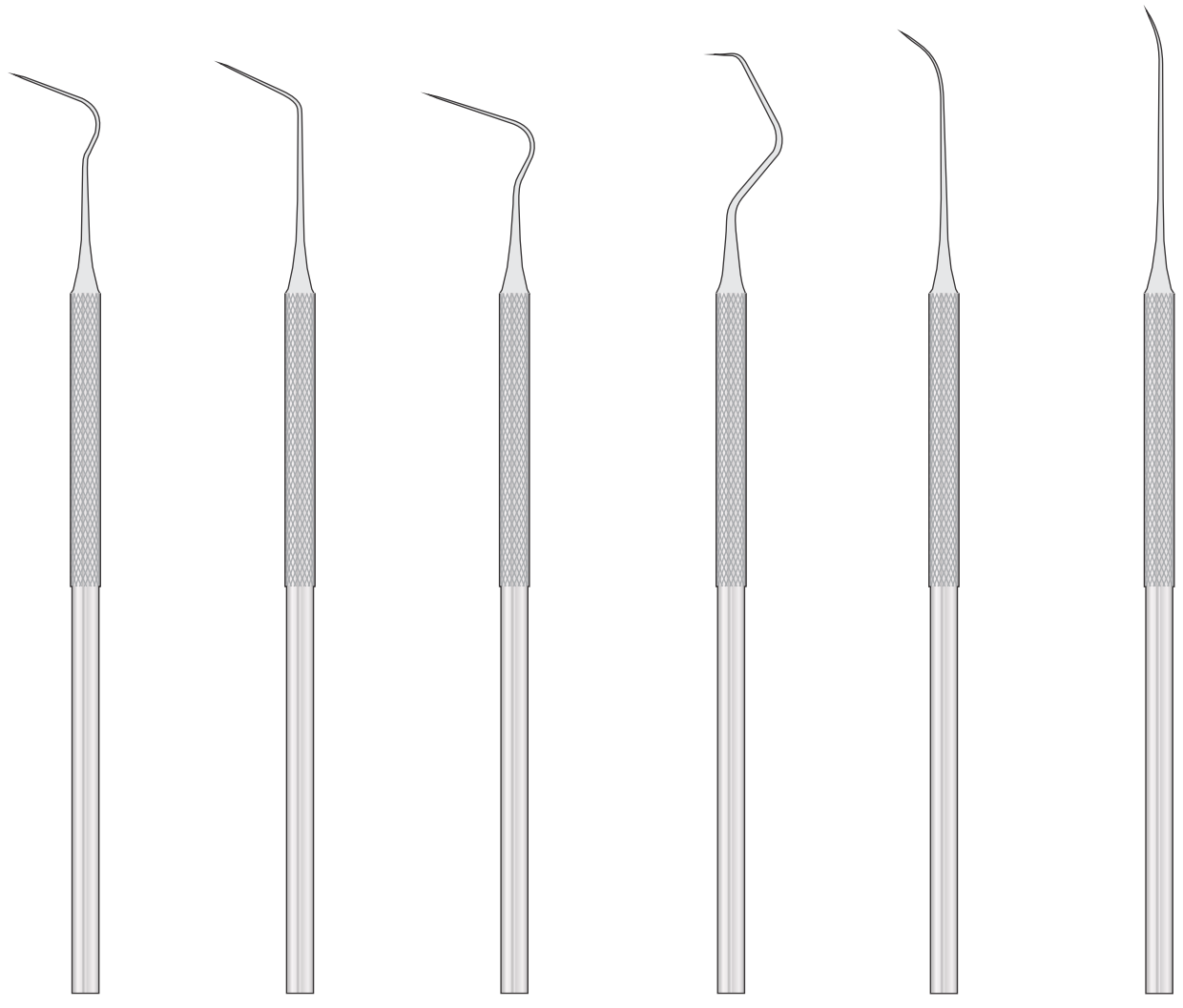
**NMI-SO-5**  
Fig. 2



**NMI-SO-6**  
Fig. 10



Zahnsonden  
Explorers - Sickle Probes  
Esploratori - Sonde falce  
Sondas exploradoras  
Sondes exploratrices



**NMI-SO-7**  
Fig. 12

**NMI-SO-8**  
Fig. 6A

**NMI-SO-9**  
Fig. 8A

**NMI-SO-10**  
Fig. 17A

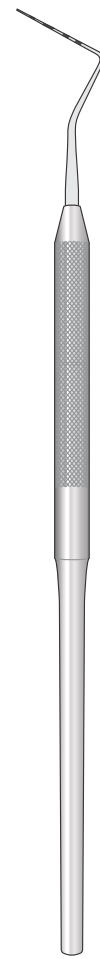
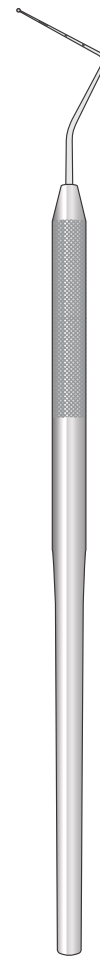
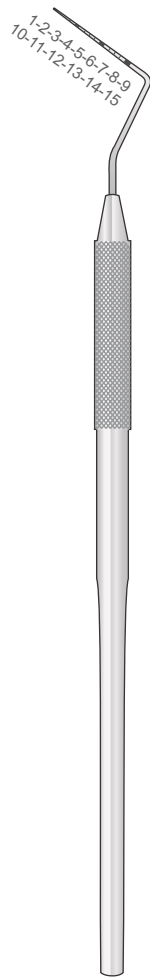
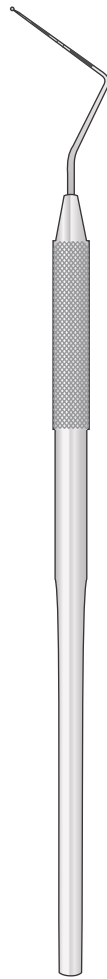
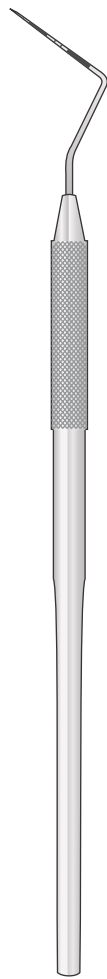
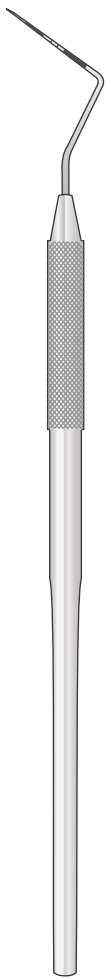
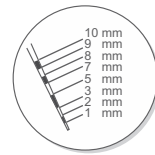
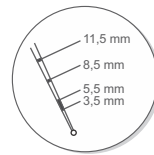
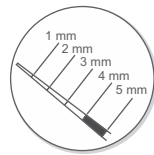
**NMI-SO-11**  
Fig. 3A

**NMI-SO-12**  
Fig. 3



Parodontometer  
Periodontal Probes  
Sonde parodontali  
Sondas parodontales  
Sondes parodontales

Do not sterilizing with ultra sound - Not Metal brushes  
Non sterilizzare in ultrasuoni - No spazzola metallica



CNMI-P1 1  
NMI-SM-1 1  
160 mm

CNMI-P12  
NMI-SM-12  
160 mm

CNMI-P12S  
NMI-SM-13  
160 mm

CNMI-P15UNC  
NMI-SM-15  
160 mm

WHO  
NMI-SM-21  
160 mm

CNMI-P10  
NMI-SM-19  
160 mm

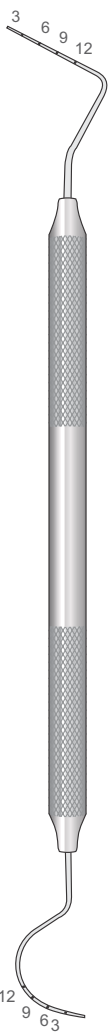


Parodontometer  
Periodontal Probes  
Sonde parodontali  
Sondas parodontales  
Sondes parodontales

Double-ended Explorer  
Doppelendiger Zahnsonden  
Sonde exploratrice double  
Sonda exploradora doble  
Sonda falce doppia



11/12 ODU  
NMI-SO-20  
165 mm

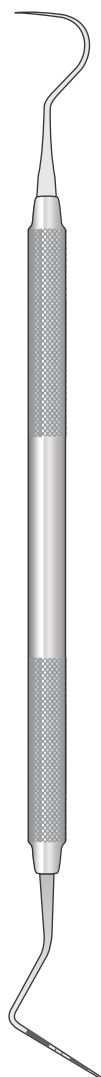
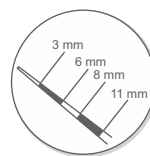


UT3/4 CATTONI  
NMI-SM-20  
165 mm

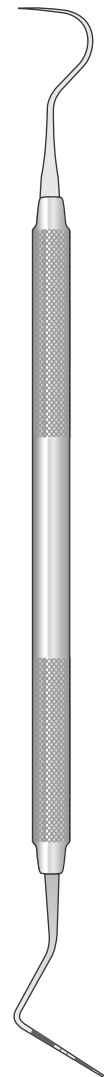
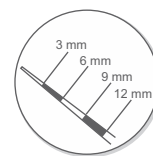
3 - 6 - 9 - 12



2QN NABERS  
NMI-SM-22  
175 mm



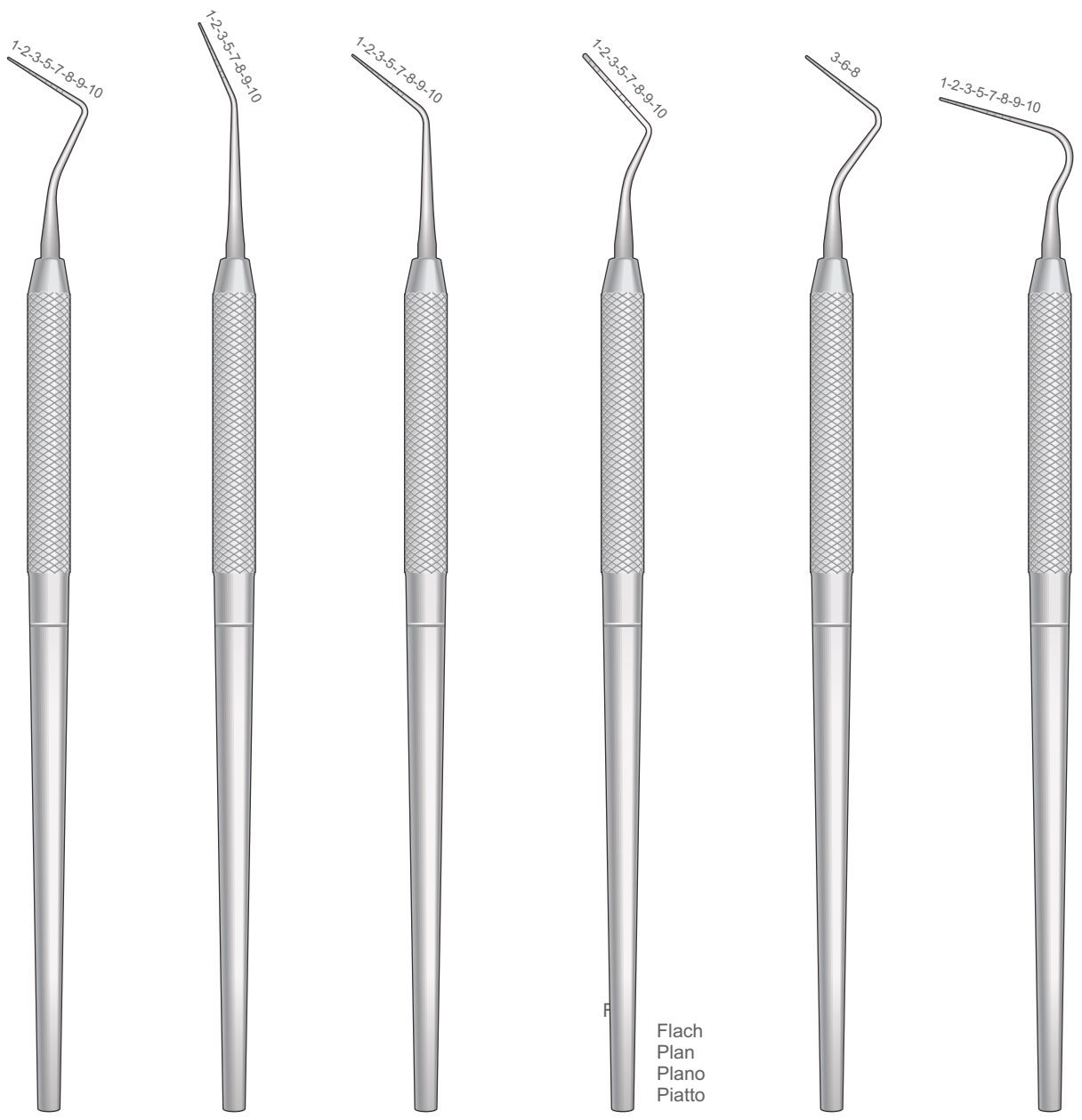
23 CNMI-P1 1  
NMI-EX-1 1



23 CNMI-P12  
NMI-EX-12



Parodontometer  
Periodontal Probes  
Sonde parodontali  
Sondas parodontales  
Sondes parodontales



WILLIAMS  
NMI-SM-1

MERRITA  
NMI-SM-2

MERRIB  
NMI-SM-3

GOLDMAN-FOX  
NMI-SM-4

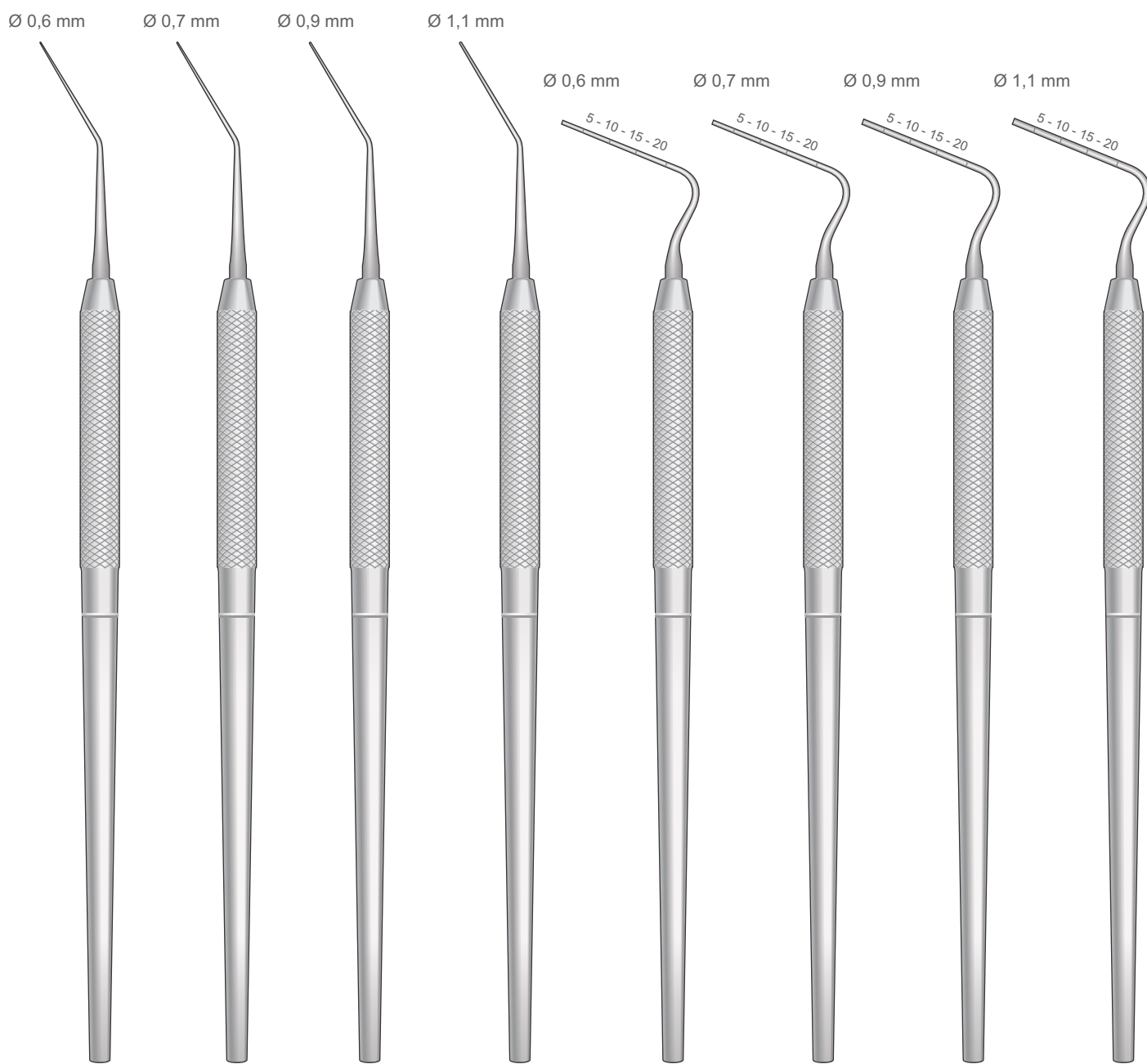
F  
Flach  
Plan  
Plano  
Piatto

UNIVERSITY  
OF MICHIGAN  
NMI-SM-5

26 G  
NMI-SM-6



Instrumente für Endodontie  
Endodontic Instruments  
Strumenti per Endodonzia  
Instrumentos para Endodoncia  
Instruments pour Endodontie



LUKS  
NMI-PL-1  
Fig.1

LUKS  
NMI-PL-2  
Fig.2

LUKS  
NMI-PL-3  
Fig.3

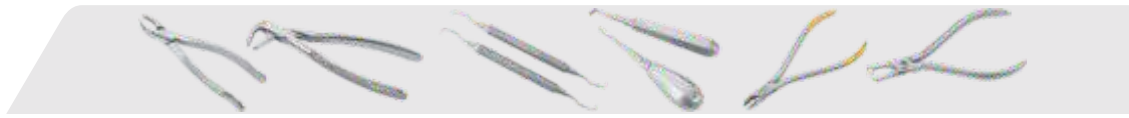
LUKS  
NMI-PL-4  
Fig.4

NMI-PZ-1  
Fig.1

NMI-PZ-2  
Fig.2

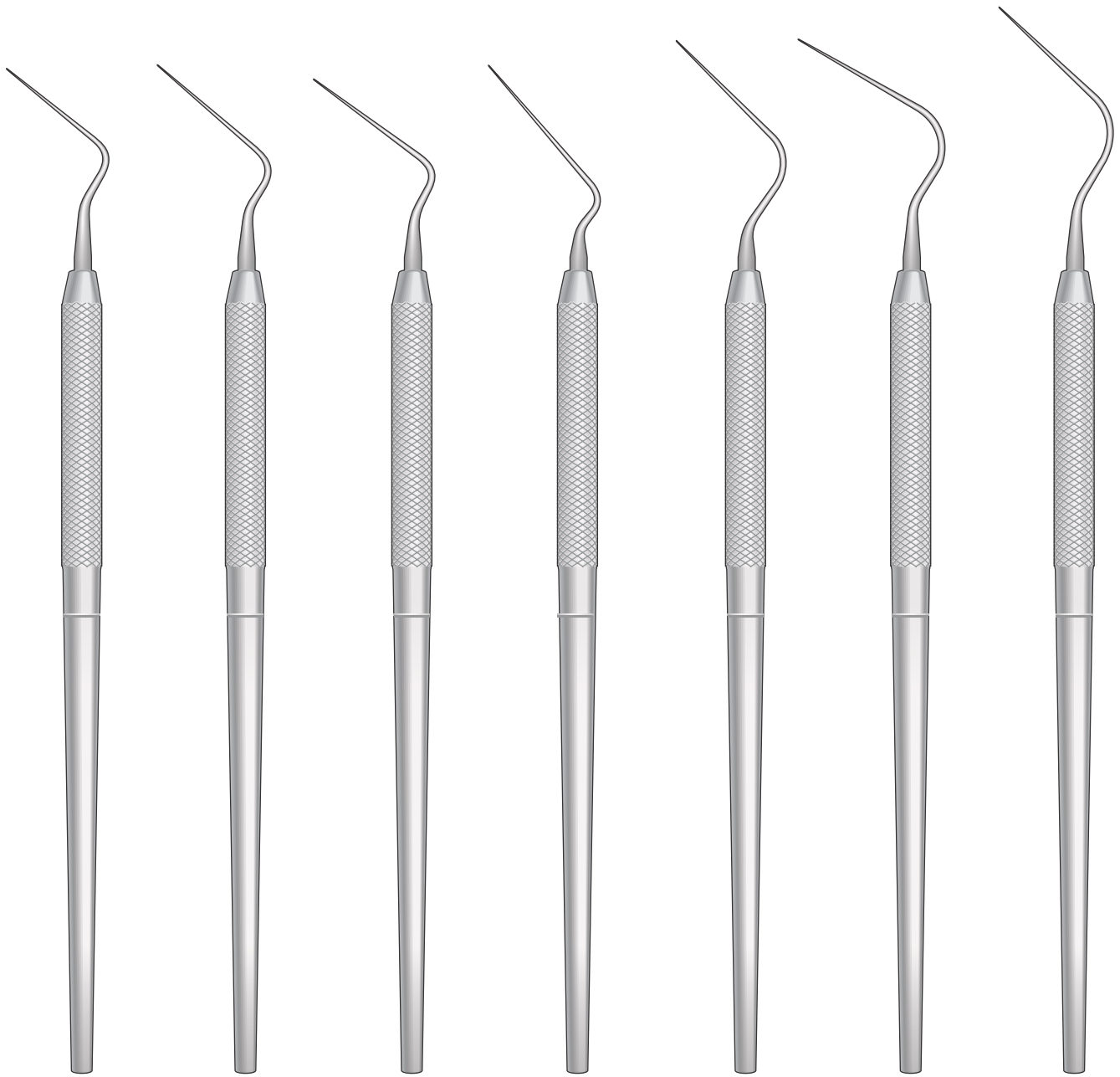
NMI-PZ-3  
Fig.3

NMI-PZ-4  
Fig.4



Instrumente für Endodontie  
Endodontic Instruments  
Strumenti per Endodonzia  
Instrumentos para Endodoncia  
Instruments pour Endodontie

Spreaders



**NMI-SNMI-P1**  
Fig.1S

**NMI-SNMI-P2**  
Fig.2S

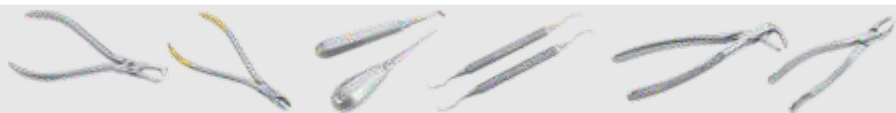
**NMI-SNMI-P3**  
Fig.D1

**NMI-SNMI-P4**  
Fig.MA57

**NMI-SNMI-P5**  
Fig.0

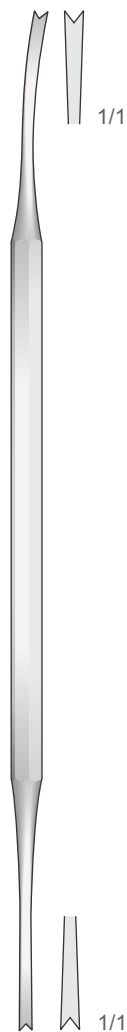
**NMI-SNMI-P6**  
Fig.00

**NMI-SNMI-P7**  
Fig.3



Watteträger  
Cotton Applicators  
Porta cotone  
Portaalgodón  
Applicateur de coton

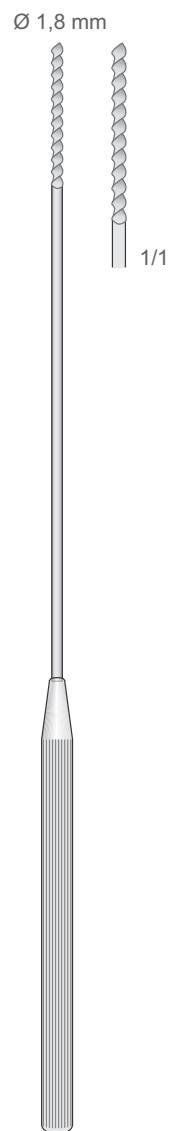
Tamponstopfer  
Gauze Packers  
Porta tamponi  
Portatampones  
Porte tampons



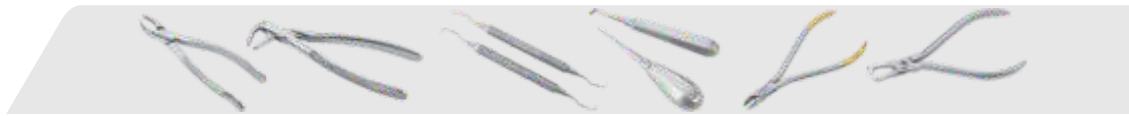
**LUNIATSCHEK  
NMI-PF-6**  
170 mm



**UNIVERSAL  
NMI-PF-40**  
140 mm



**UNIVERSAL  
NMI-PF-41**  
180 mm



Mundspiegel und Griffe  
Mirrors and handles  
Specchietti e manici  
Espejos y mangos  
Miroirs et manches

Box of 12

NMI-P3	# 3 - Ø 18mm	Flach Plane Piano Plano Plan
NMI-P4	# 4 - Ø 22mm	
NMI-P5	# 5 - Ø 24mm	

Rhodiumspiegel  
Rhodium Mirror  
Specchietto rodiato  
Espejo de rodio  
Miroir au rhodium

Box of 12

NMI-RH-4	# 4 - Ø 22mm
NMI-RH-5	# 5 - Ø 24mm

Simple Stem

Box of 12

NMI-RH-4A
NMI-RH-5A

Cone Socket

Box of 12

NMI-G-3	# 3 - Ø 18mm	Hohl-Vergrößernd Concave with enlarging effect Concavo con ingrandimento Còncavo con efecto de aumento Creux avec effect d'agrandissant
NMI-G-4	# 4 - Ø 22mm	
NMI-G-5	# 5 - Ø 24mm	

Box of 6

NMI-RH-14	# 4 - Ø 22mm
-----------	--------------

MEGA DUO  
RHODIUM n.4

Beidseitig Rhodium Beschichtet  
Both sides Rhodium-coated  
Con rivestimento in rodio su entrambi i lati  
Revestido con rodio en ambos lados  
Revêtu de rhodium des deux côtés

Massiv - Solid  
Pieno - Sólido - Solide

Hohl - Hollow  
Vuoto - Hueco - Creux

NMI-MA-1  
Simple Stem  
120 mm

NMI-MA-1A  
Cone Socket  
120 mm

NMI-MA-2  
Simple Stem  
125 mm

NMI-MA-2A  
Cone Socket  
125 mm

**inox**  
STAINLESS STEEL

NMI-MA-3  
125 mm

NMI-AL-MA5  
120 mm

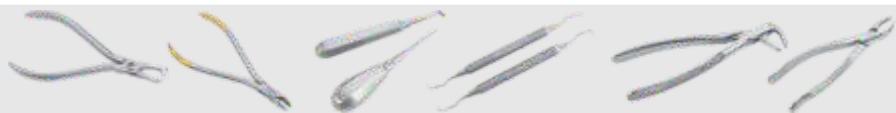
NMI-MA-7  
135 mm

**Cr**  
CHROMIUM

**Al**  
ALUMINIUM

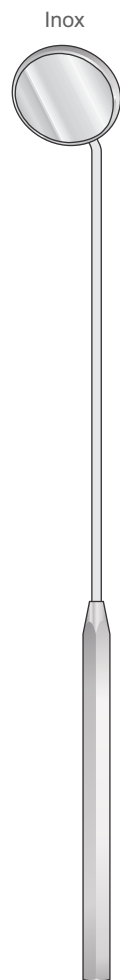
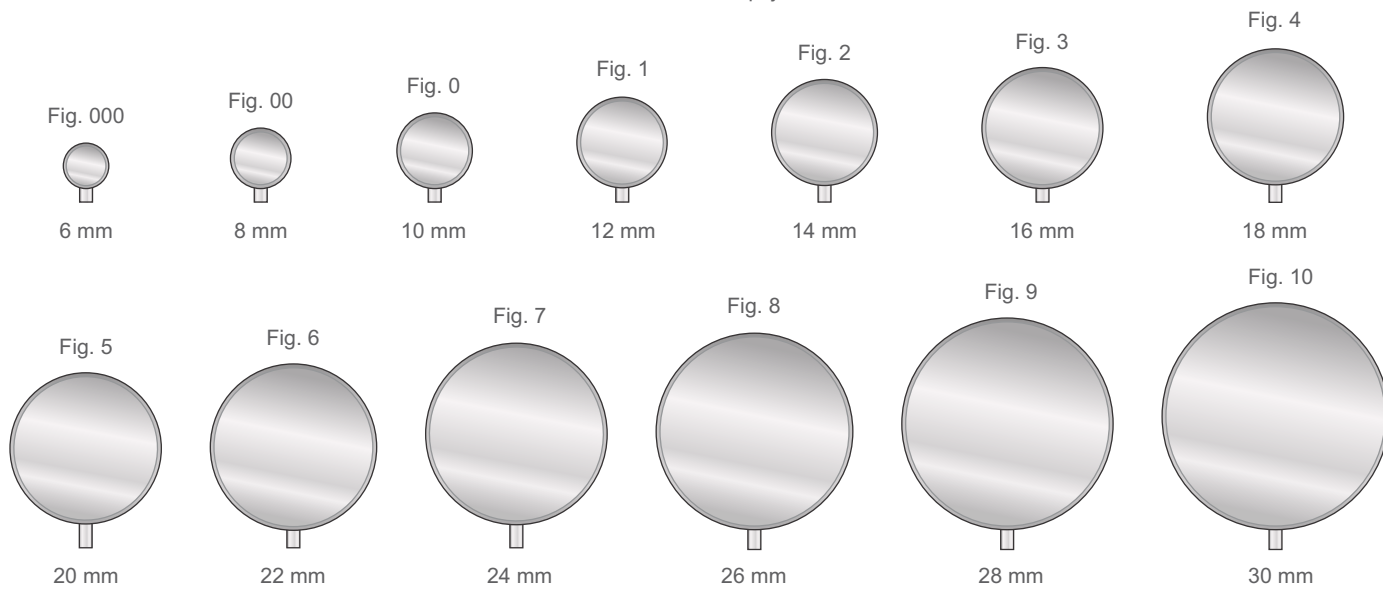
**inox**  
STAINLESS STEEL





Mundspiegel und Griffe  
Mirrors and handles  
Specchietti e manici  
Espejos y mangos  
Miroirs et manches

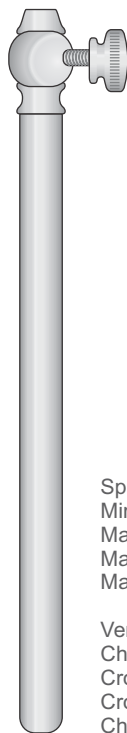
Spiegeldurchmesser - Diameter of mirrors  
Diametro dello specchio - Diamètre des miroirs  
Diámetro de los espejos



Kehlkopfspiegel mit  
Sechskantgriff  
Laryngeal mirrors  
with hexagonal handle  
Specchietto laringeo  
con manico esagonale  
Espejo laringeo  
con mango hexagonal  
Miroirs laryngiens  
avec manche hexagonal

- NMI-G-8 Fig. 00
- NMI-G-10 Fig. 0
- NMI-G-12 Fig. 1
- NMI-G-14 Fig. 2
- NMI-G-16 Fig. 3
- NMI-G-18 Fig. 4
- NMI-G-20 Fig. 5
- NMI-G-22 Fig. 6
- NMI-G-24 Fig. 7
- NMI-G-26 Fig. 8
- NMI-G-28 Fig. 9
- NMI-G-30 Fig. 10

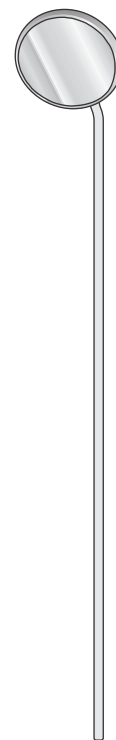
NMI-G-8/NMI-G-30  
180 mm



Spiegelgriff  
Mirrors handle  
Manico per specchietti  
Mango para espejos  
Manche à miroir

Verchromt  
Chromium  
Cromato  
Cromado  
Chromé

NMI-MA-6  
120 mm



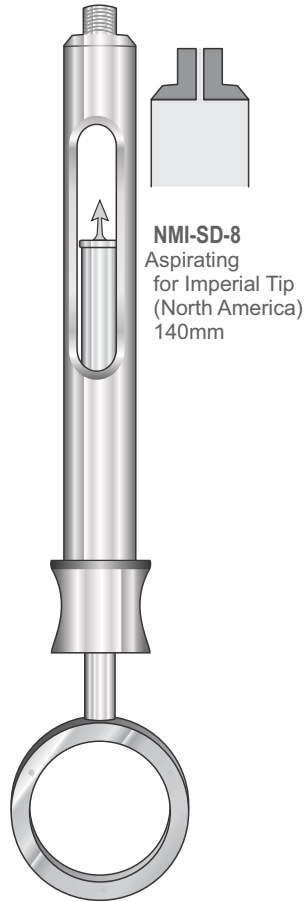
Kehlkopfspiegel  
Laryngeal mirrors  
Specchietto laringeo  
Espejos laringeos  
Miroirs laryngiens

- NMI-P000 Fig. 000
- NMI-P00 Fig. 00
- NMI-P0 Fig. 0
- NMI-P01 Fig. 1
- NMI-P02 Fig. 2
- NMI-P03 Fig. 3
- NMI-P04 Fig. 4
- NMI-P05 Fig. 5
- NMI-P06 Fig. 6

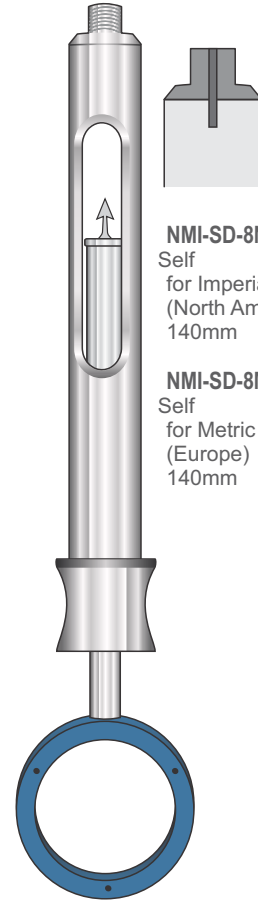
NMI-P000/NMI-P06  
120 mm



Dental-Spritzen  
Dental Syringes  
Siringhe dentali  
Jeringas dentales  
Seringues dentaires



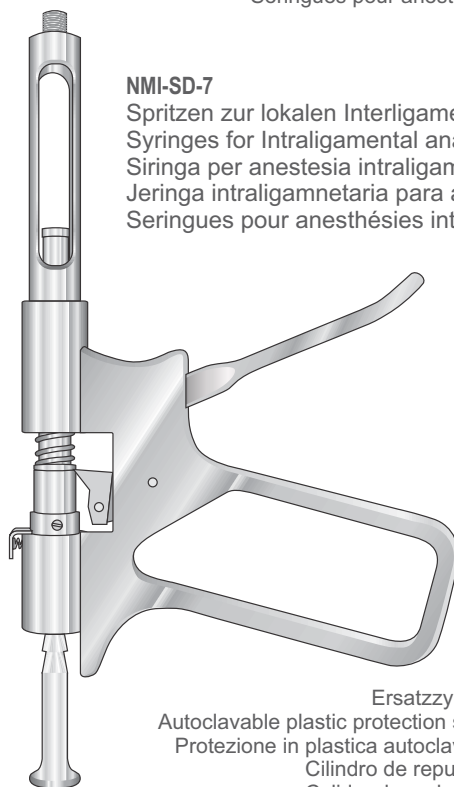
**NMI-SD-8**  
Aspirating  
for Imperial Tip  
(North America)  
140mm



**NMI-SD-8NA** Aspirating  
Self  
for Imperial Tip  
(North America)  
140mm

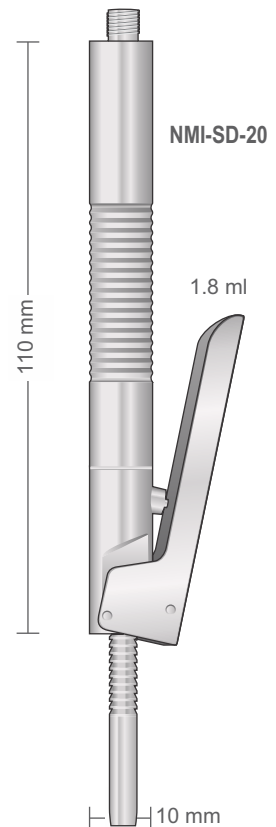
**NMI-SD-8M**  
Self  
for Metric Tip  
(Europe)  
140mm

Spritzen zur lokalen Interligamentär-Anästhesie  
Syringes for Intraligamental anaesthesia  
Siringa per anestesia intraligamentare  
Jeringa intraligamentaria para anestesia  
Seringues pour anesthésies intraligementaires



**NMI-SD-7**  
Spritzen zur lokalen Interligamentär-Anästhesie  
Syringes for Intraligamental anaesthesia  
Siringa per anestesia intraligamentare  
Jeringa intraligamentaria para anestesia  
Seringues pour anesthésies intraligementaires

**NMI-SD-7R**  
Ersatzzylinder für NMI-SD-7  
Autoclavable plastic protection sleeve for NMI-SD-7  
Protezione in plastica autoclavabile per NMI-SD-7  
Cilindro de repuesto para NMI-SD-7  
Cylindre de rechange pour NMI-SD-7

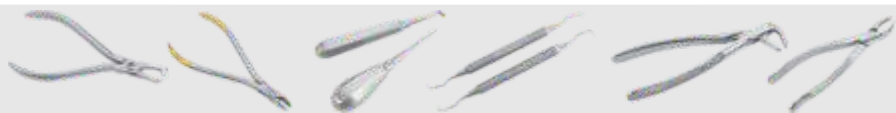


**NMI-SD-20**

1.8 ml

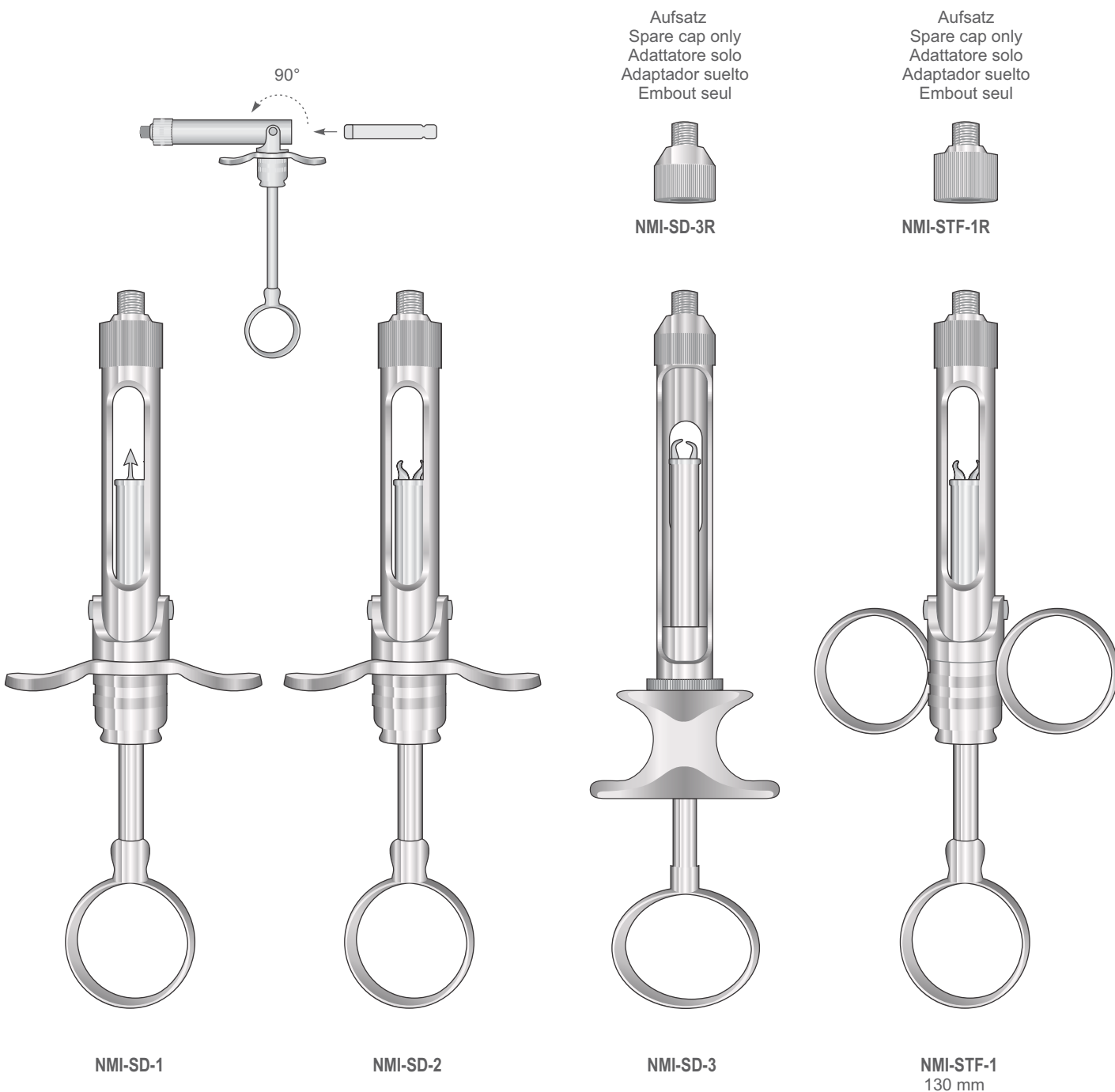
110 mm

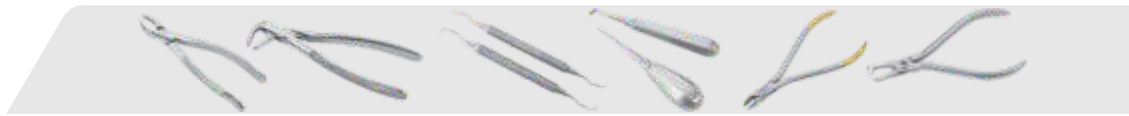
10 mm



Dental-Spritzen  
Dental syringes  
Siringhe dentali  
Jeringas dentales  
Seringues dentaires

Zylinder-Ampullen Spritzen  
Cartridge Syringes  
Siringhe per tubofiale  
Jeringas de ampollas  
Seringues d'ampoules





Küretten  
Curettes  
Curette  
Curetas  
Curettes



GRACEY  
NMI-CU-1/2



GRACEY  
NMI-CU-3/4



GRACEY  
NMI-CU-5/6



GRACEY  
NMI-CU-7/8



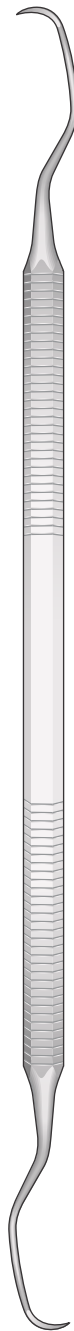
GRACEY  
NMI-CU-9/10



GRACEY  
NMI-CU-1 1/12



GRACEY  
NMI-CU-13/14



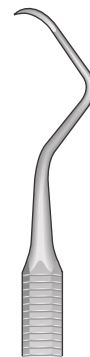
LANGER Fig.1/2  
NMI-COL-1/2



LANGER Fig.3/4  
NMI-COL-3/4



COLUMBIA  
NMI-COL-2RL



COLUMBIA  
NMI-COL-4RL



COLUMBIA  
NMI-COL-13/14



Hollow  
Hohl  
Creux  
Hueco  
Vuoto



Scaler und Küretten  
Scalers and Curettes  
Scaler e Curette  
Raspadores y Curetas  
Déartreurs et Curettes



**NMI-USG-1/2ET**  
Gracey  
Curette 1/2ET



**NMI-USG-3/4ET**  
Gracey  
Curette 3/4ET



**NMI-USG-5/6ET**  
Gracey  
Curette 5/6ET



**NMI-USG-7/8ET**  
Gracey  
Curette 7/8ET



**NMI-USG-9/10ET**  
Gracey  
Curette 9/10ET



**NMI-USG-1 1/12ET**  
Gracey  
Curette 11/12ET



**NMI-USG-13/14ET**  
Gracey  
Curette 13/14ET



**NMI-USG-15/16ET**  
Gracey  
Curette 15/16ET



Scaler und Küretten  
Scalers and Curettes  
Scaler e Curette  
Raspadores y Curetas  
Détartreurs et Curettes



Hollow  
Hohl  
Creux  
Hueco  
Vuoto



Ø 9 mm



- |  |   |   |   |   |   |  |   |
|--|---|---|---|---|---|--|---|
|  |   |   |   |   |   |  |   |
|  | <b>NMI-USG-1/2</b><br>Gracey<br>Curette 1/2   | <b>NMI-USG-3/4</b><br>Gracey<br>Curette 3/4   | <b>NMI-USG-5/6</b><br>Gracey<br>Curette 5/6   | <b>NMI-USG-7/8</b><br>Gracey<br>Curette 7/8   | <b>NMI-USG-9/10</b><br>Gracey<br>Curette 9/10   | <b>NMI-USG-1 1/12</b><br>Gracey<br>Curette 11/12   | <b>NMI-USG-13/14</b><br>Gracey<br>Curette 13/14   |
|  |   |   |   |   |   |  |   |
|  | <b>NMI-USG-1/2S</b><br>Gracey<br>Curette 1/2S | <b>NMI-USG-3/4S</b><br>Gracey<br>Curette 3/4S | <b>NMI-USG-5/6S</b><br>Gracey<br>Curette 5/6S | <b>NMI-USG-7/8S</b><br>Gracey<br>Curette 7/8S | <b>NMI-USG-9/10S</b><br>Gracey<br>Curette 9/10S | <b>NMI-USG-1 1/12S</b><br>Gracey<br>Curette 11/12S | <b>NMI-USG-13/14S</b><br>Gracey<br>Curette 13/14S |



Scaler und Küretten  
Scalers and Curettes  
Scaler e Curette  
Raspadores y Curetas  
Détartreurs et Curettes



**NMI-USG-1/2L**  
Gracey  
Curette 1/2L

**NMI-USG-3/4L**  
Gracey  
Curette 3/4L

**NMI-USG-5/6L**  
Gracey  
Curette 5/6L

**NMI-USG-7/8L**  
Gracey  
Curette 7/8L

**NMI-USG-9/10L**  
Gracey  
Curette 9/10L

**NMI-USG-1 1/12L**  
Gracey  
Curette 11/12L

**NMI-USG-13/14L**  
Gracey  
Curette 13/14L



**NMI-USG-15/16**  
Gracey  
Curette 15/16



**NMI-USG-17/18S**  
Gracey  
Curette 17/18S



**NMI-USS-KRA1**  
Kramer  
Curette 1



**NMI-USS-KRA3**  
Kramer  
Curette 3



**NMI-USG-KN1/26**  
Kramer-Nevins  
Chisels 1/2



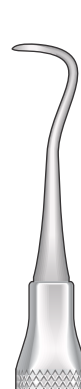
**NMI-USS-MC11/12**  
McCall  
Scaler 11/12



**NMI-USS-MC13/14**  
McCall  
Curette 13/14



**NMI-USS-MC13/14S**  
McCall  
Curette 13S/14S



**NMI-USS-MC17/18S**  
McCall  
Curette 17S/18S



**NMI-USC-2RL**  
Columbia  
Curette 2RL



**NMI-USC-4RL**  
Columbia  
Curette 4RL



**NMI-USC-13/14**  
Columbia  
Curette 13/14



**NMI-USS-5/6LAN**  
Langer  
Curette 5/6



Scaler und Küretten  
Scalers and Curettes  
Scaler e Curette  
Raspadores y Curetas  
Détartreurs et Curettes



Hollow  
Hohl  
Creux  
Hueco  
Vuoto



Ø 9 mm



**NMI-USS-NV0**  
Scaler  
Nv0



**NMI-USS-NV11/12**  
Scaler  
NV11/12



**NMI-USS-NV13/14**  
Scaler  
NV13/14



**NMI-USS-T2/3**aylor  
T  
Scaler 2/3



**NMI-USS-204S**  
Scaler  
204S



**NMI-USS-H6/7**  
T  
Scaler  
H6/H7



**NMI-USS-15/33**  
T  
Scaler  
U15/33



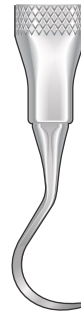
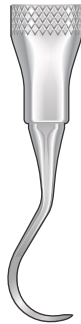
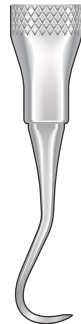
**NMI-USS-5/33**  
T  
Scaler  
H5/33

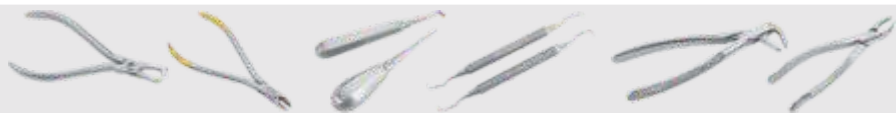


**NMI-USS-15/30**  
T  
Scaler  
U15/30



**NMI-USS-J14/15**  
Jaquette  
Scaler  
J14/15





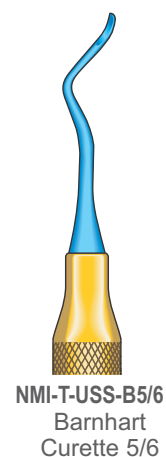
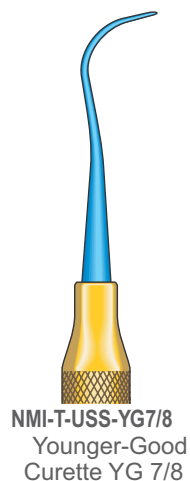
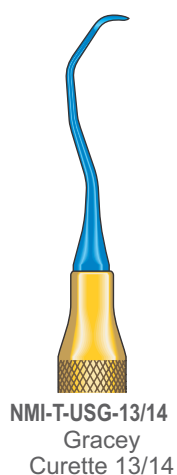
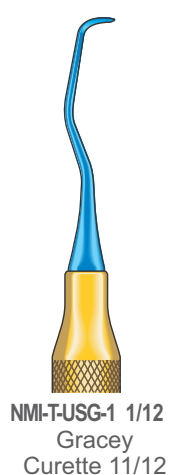
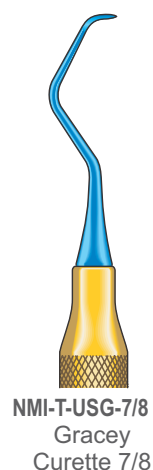
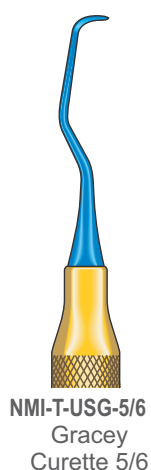
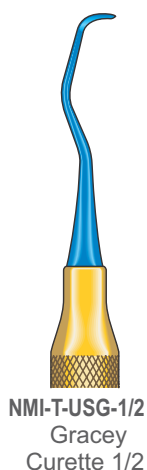
Hollow  
Hohl  
Creux  
Hueco  
Vuoto



**Elite Titanium**

Scaler und K retten  
Scalers and Curettes  
Scaler e Curette  
Raspadores y Curetas  
D tarteurs et Curettes

Designed for removing calculus on implants surfaces.  
Gold coloured handle with a titanium coating for easy identification purposes  
so they won't be mixed up with standard stainless instruments.

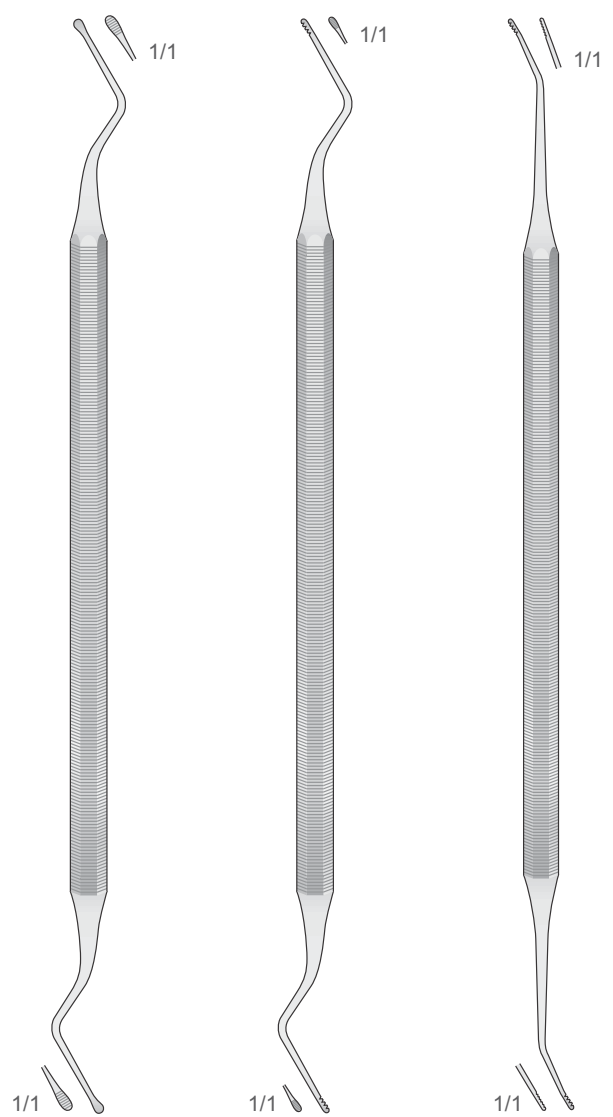
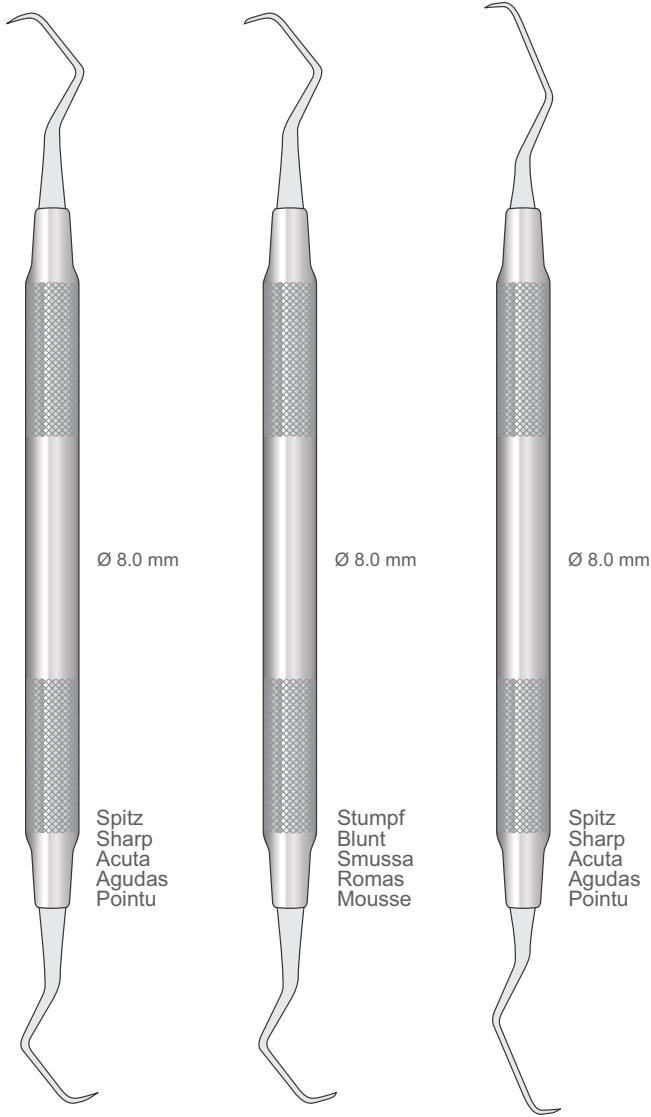




Küretten - Feilen  
Curettes - Files  
Curette - Lime  
Curetasc - Lima  
Curettes - Limes

Universal Küretten  
Universal Curettes  
Curette universali  
Curetasc universales  
Curettes universelles

Parodontalfeilen  
Periodontal Files  
Lime parodontali  
Limas parodontales  
Limes parodontales



**NMI-718-M23**  
165 mm

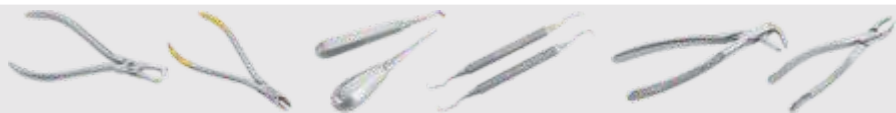
**NMI-718-M23A**  
165 mm

**NMI-718-M23B**  
170 mm

**HIRSCHFELD  
NMI-HF-3/7**  
170 mm

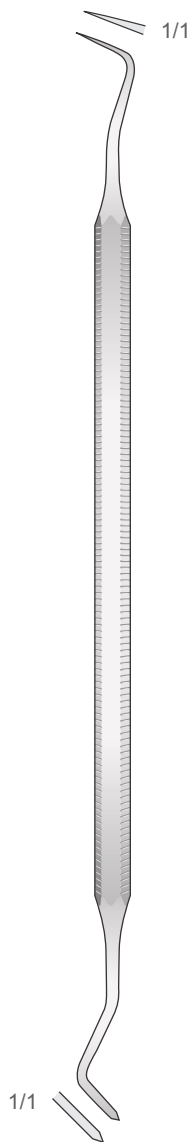
**HIRSCHFELD  
NMI-HF-5/1**  
170 mm

**HIRSCHFELD  
NMI-HF-9/10**  
175 mm

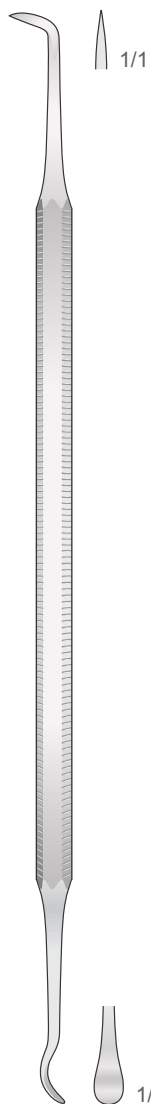


Scaler  
Scalers  
Ablatori di tartaro  
Limpiadores  
Détartreurs

Scalers



LANGE  
NMI-PF-9  
160 mm



MITCHEL  
NMI-AT-12  
170 mm



NMI-AT-1



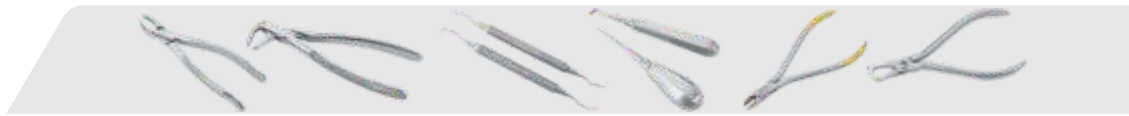
NMI-AT-2R



NMI-AT-2L

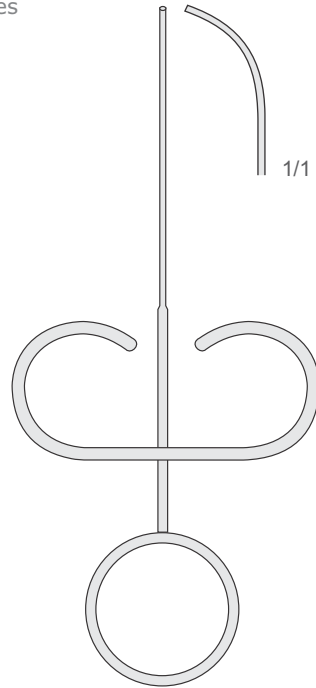


NMI-AT-6



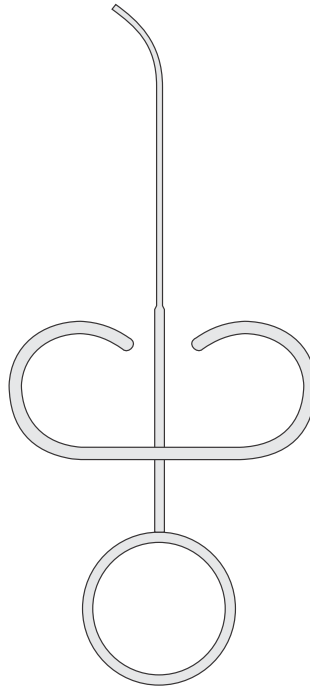
Amalgampistole für retrograde  
Amalgam gun for retrograde  
Siringhe portamalgame retrogradi  
Portaamalgama para retrógradas  
Porte-amalgame pour rétrogrades

Nach oben Gebogen - Curved up  
Curva in avanti - Curvas hacia arriba  
Courbes vers le haut  
Ø 0,9 mm



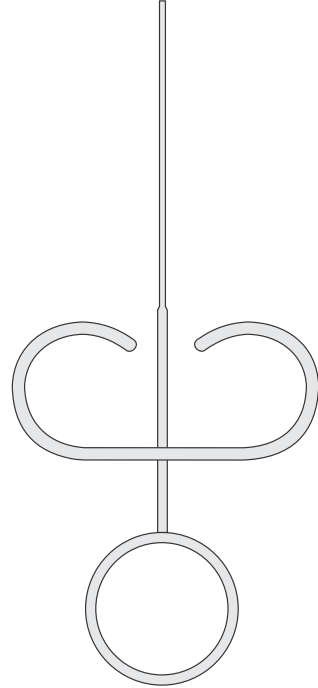
**NMI-SS-51**  
130 mm

Seitwärts Gebogen - Curved to side  
Curva sul lato - Curvas laterales  
Courbes latérales  
Ø 0,9 mm



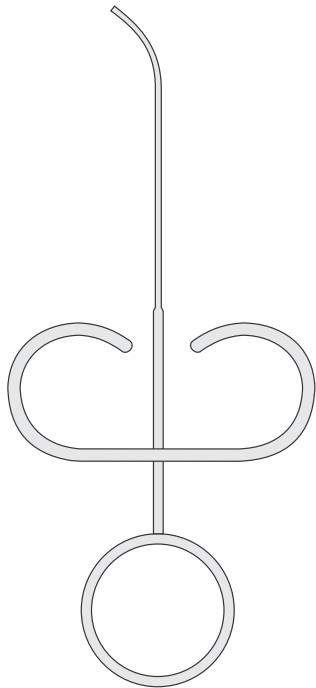
**NMI-SS-55**  
130 mm

Gerade - Straight  
Diritta - Rectas  
Droites  
Ø 1,2 mm



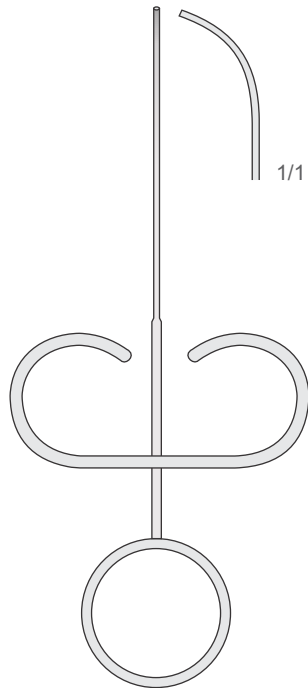
**NMI-SS-54**  
130 mm

Seitwärts Gebogen - Curved to side  
Curva sul lato - Curvas laterales  
Courbes latérales  
Ø 1,2 mm



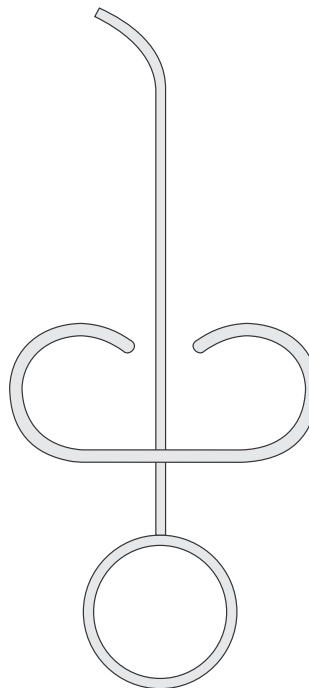
**NMI-SS-56**  
130 mm

Nach oben Gebogen - Curved up  
Curva in avanti - Curva hacia arriba  
Courbes vers le haut  
Ø 1,2 mm



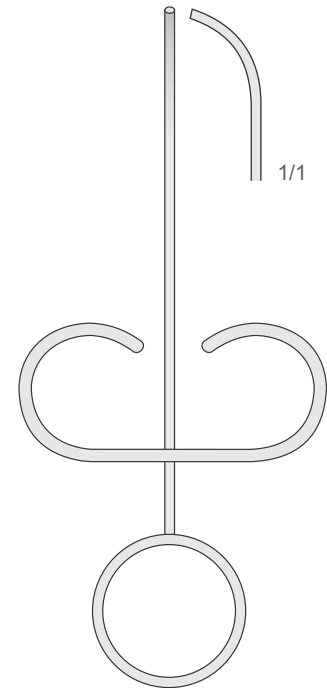
**NMI-SS-58**  
130 mm

Seitwärts Gebogen - Curved to side  
Curva sul lato - Curvas laterales  
Courbes latérales  
Ø 1,8 mm



**NMI-SS-50**  
130 mm

Nach oben Gebogen - Curved up  
Curva in avanti - Curvas hacia arriba  
Courbes vers le haut  
Ø 1,8 mm



**NMI-SS-52**  
130 mm

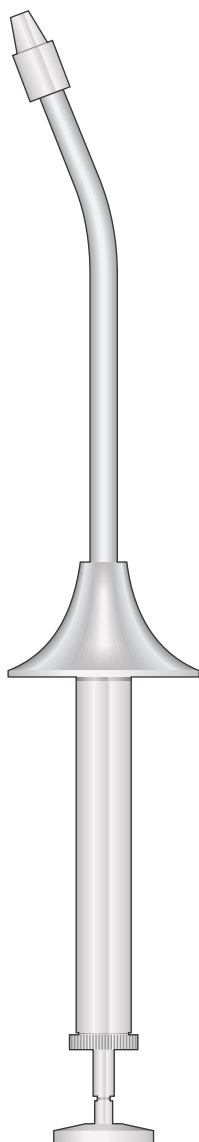


Amalgambecher  
Amalgam Well  
Mortajo per amalgama  
Vaso para amalgama  
Gobelet pour amalgame

Amalgamträger  
Amalgam Carriers  
Porta amalgama  
Porta-amalgamas  
Porte-amalgames

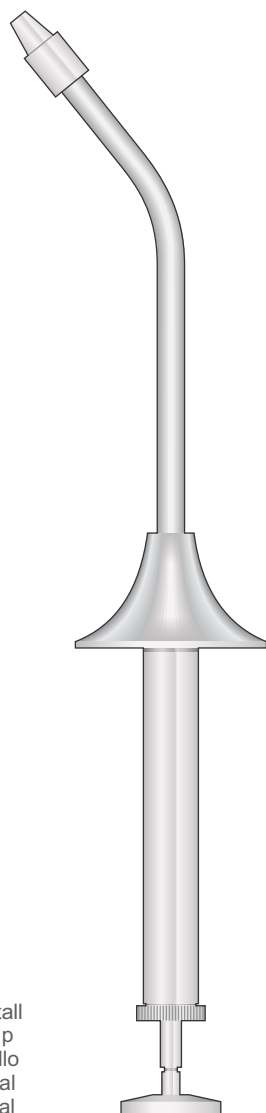


**NMI-SS-65**  
Ø 35 mm  
h. 35 mm

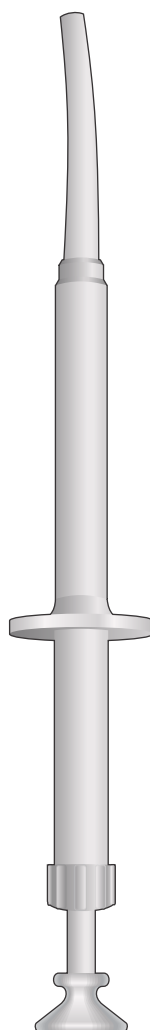


**NMI-SS-15**

Aus Metall  
Metal tip  
In metallo  
De metal  
En métal

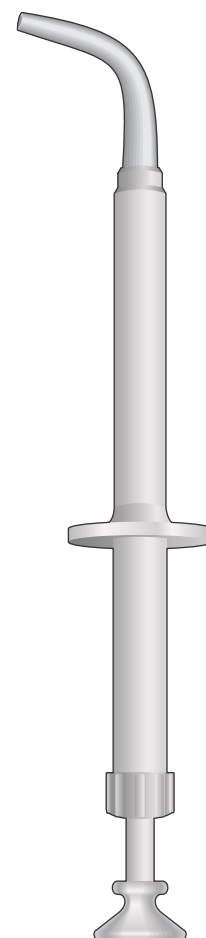


**NMI-SS-16**

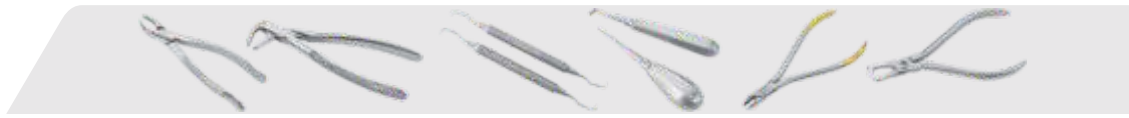


**NMI-SS-41**  
170 mm

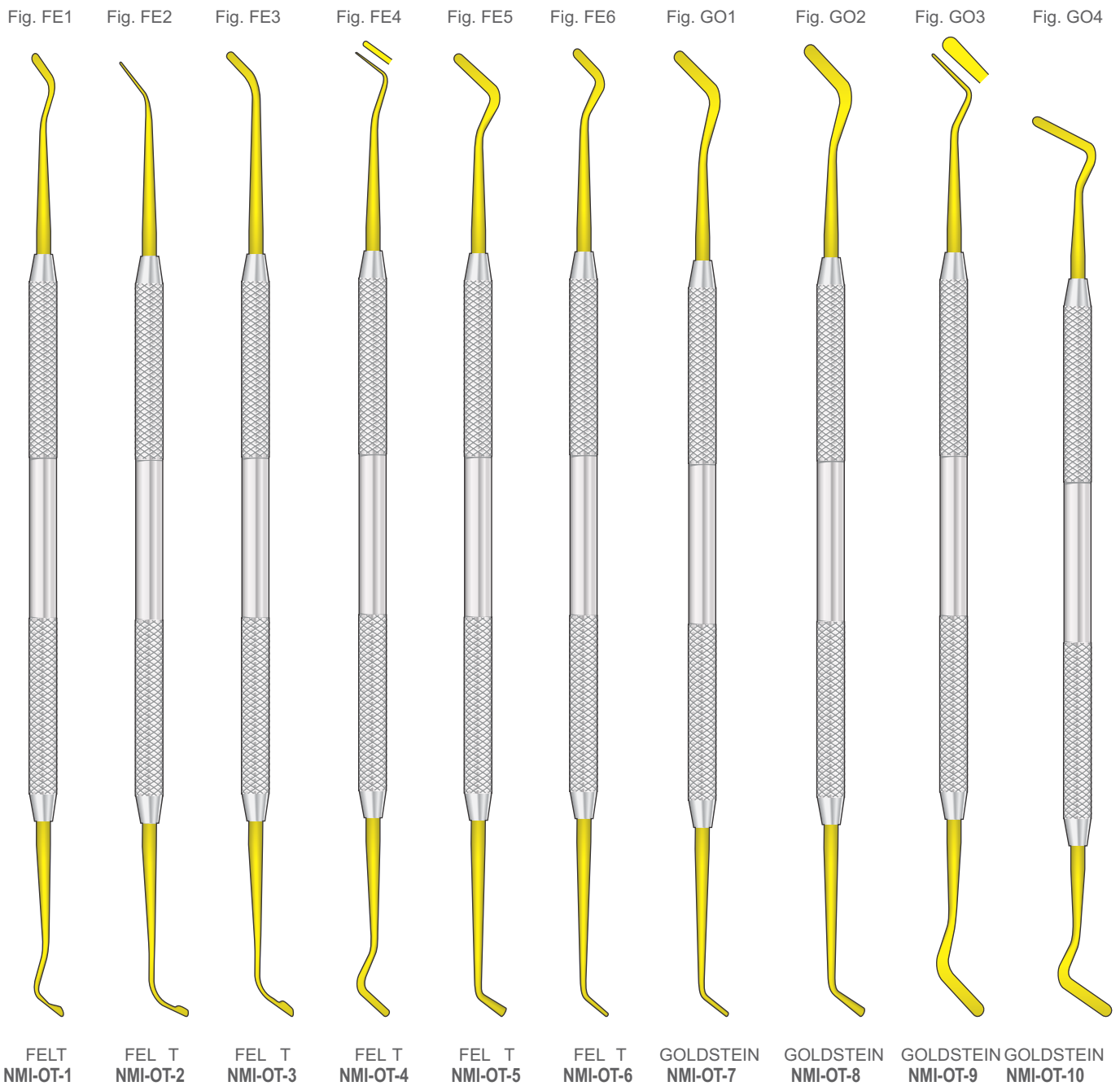
Autoclavable  
Aus Kunststoff  
Plastic tip  
In plastica  
De plàstico  
En plastique



**NMI-SS-42**  
160 mm



Kompositinstrumente  
Composite Instruments  
Strumenti per composito  
Instrumentos para composites  
Instruments pour composites

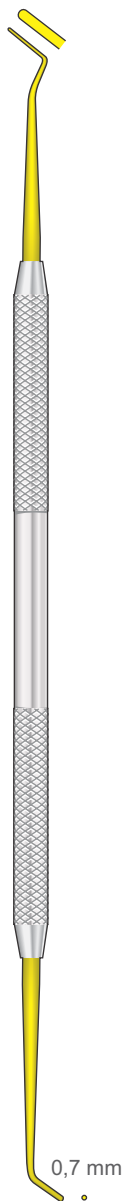




Kompositinstrumente  
Composite Instruments  
Strumenti per composito  
Instrumentos para composites  
Instruments pour composites

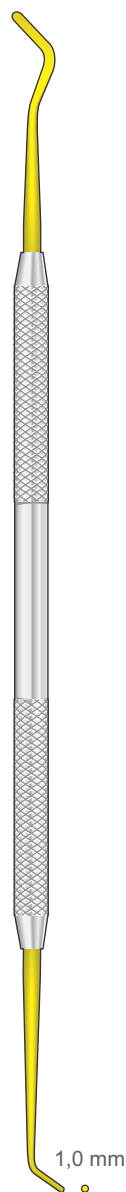


Fig. CP1  
1,5 mm



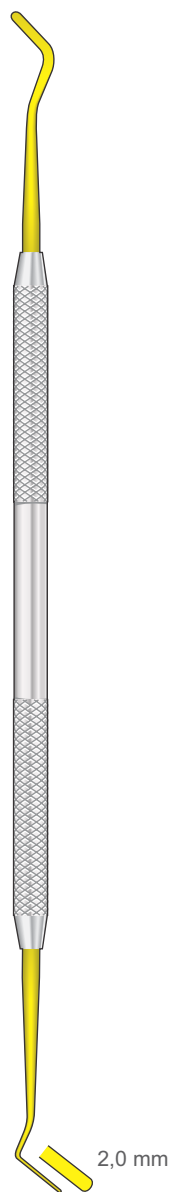
NMI-OT-1 1

Fig. CP2  
2,0 mm



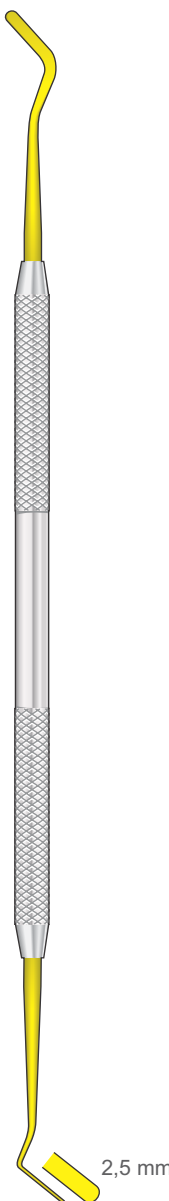
NMI-OT-12

Fig. CP3  
2,0 mm



NMI-OT-13

Fig. CP4  
2,5 mm



NMI-OT-14

Fig. CP5



NMI-OT-15

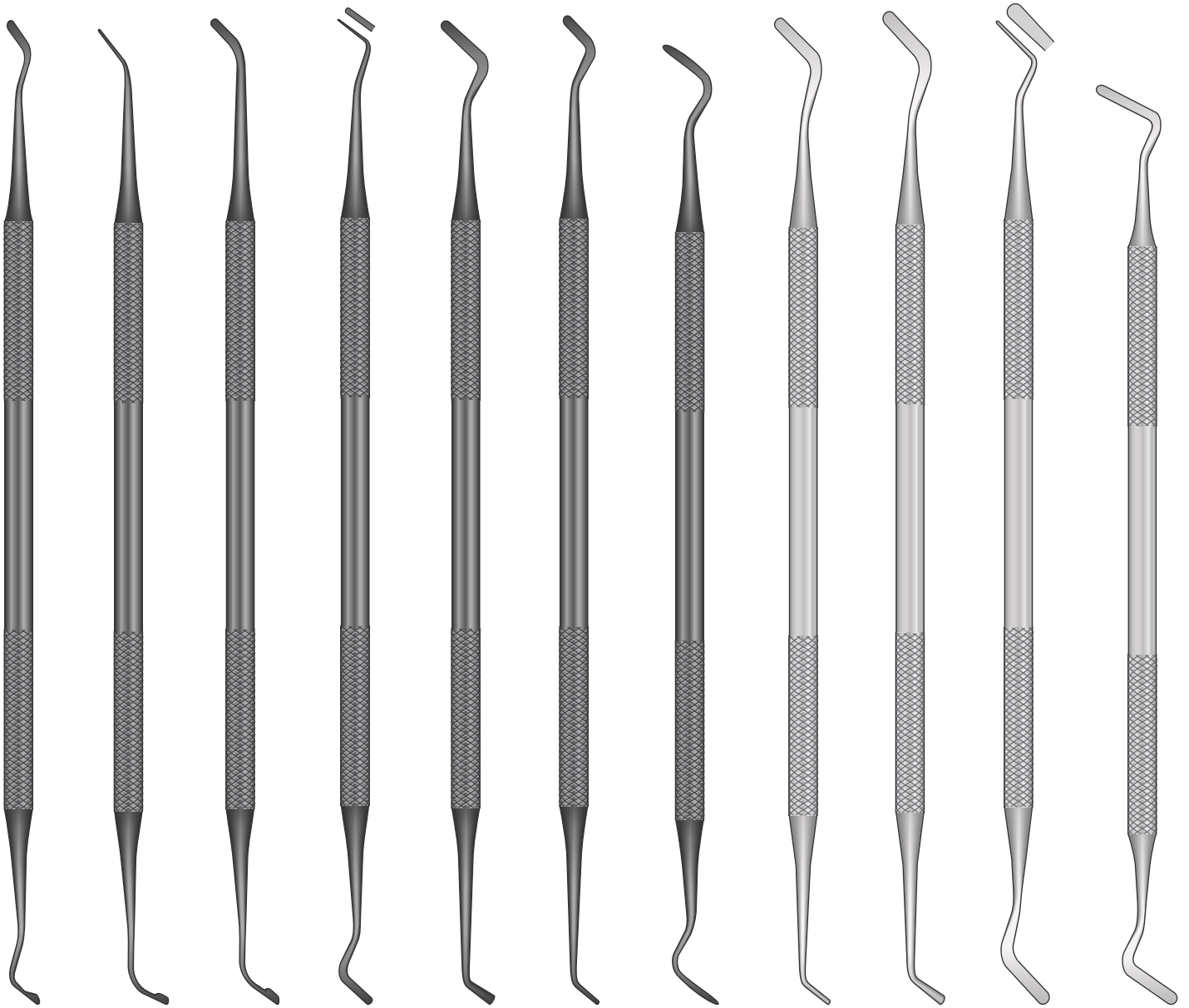
Fig. CP6



NMI-OT-16



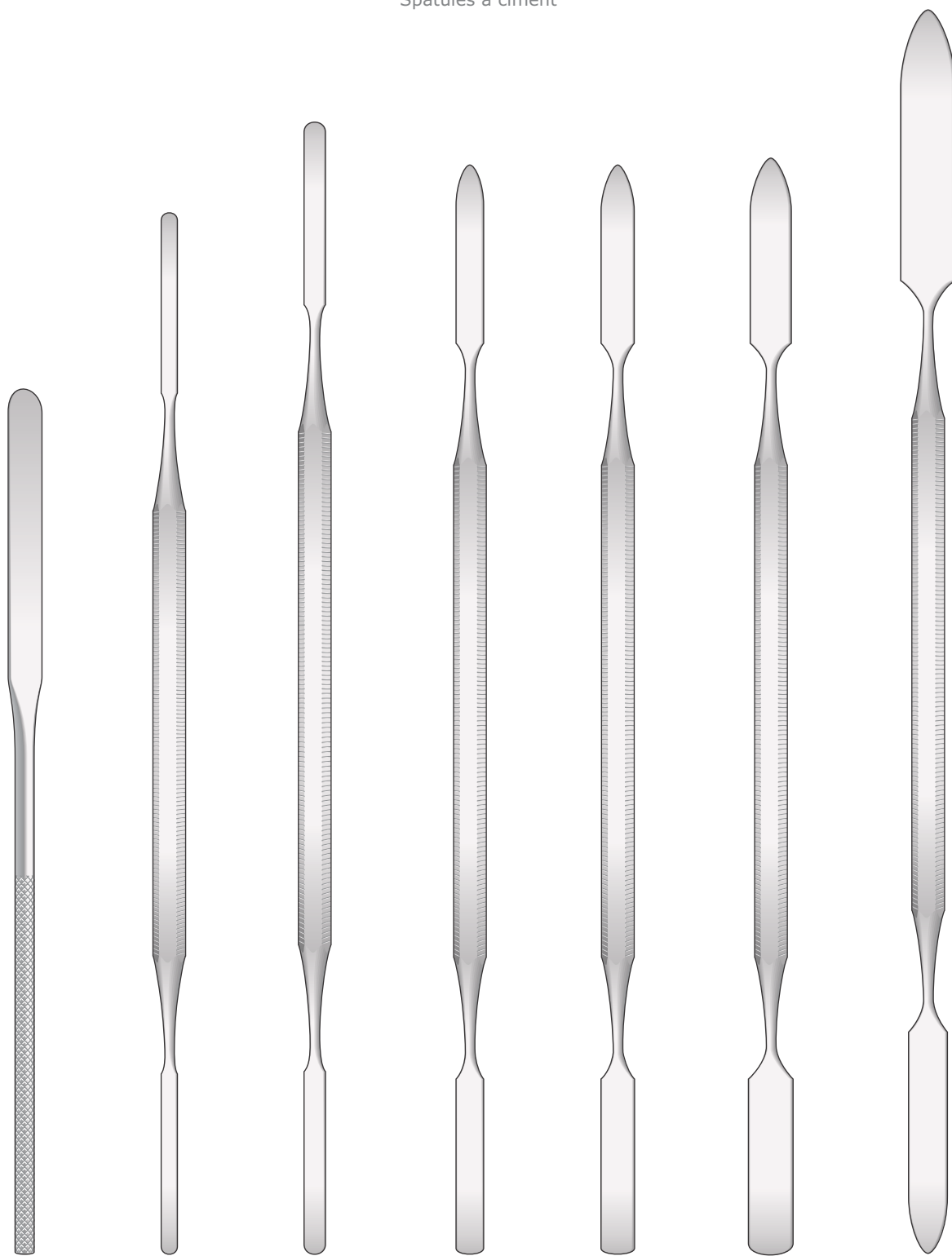
Kompositinstrumente  
Composite Instruments  
Strumenti per composito  
Instrumentos para composites  
Instruments pour composites



FELT NMI-FE-1    FELT NMI-FE-2    FELT NMI-FE-3    FELT NMI-FE-4    FELT NMI-FE-5    FELT NMI-FE-6    FELT NMI-FE-4/5    GOLDSTEIN NMI-GO-1    GOLDSTEIN NMI-GO-2    GOLDSTEIN NMI-GO-3    GOLDSTEIN NMI-GO-4



Zementspatel  
Cement Spatulas  
Spatole per cemento  
Espátulas para cemento  
Spatules à ciment



**NMI-SR**  
140 mm

**NMI-S-00**  
180 mm

**NMI-S-0**  
185 mm

**NMI-S-1**  
180 mm

**NMI-S-2**  
180 mm

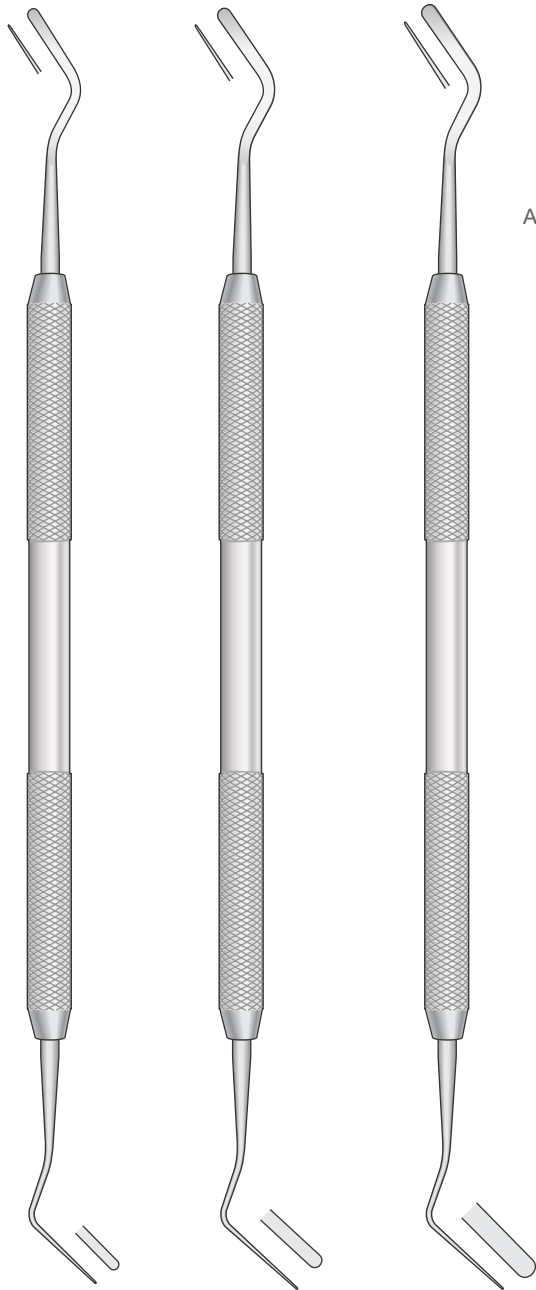
**NMI-S-3**  
180 mm

**NMI-S-4**  
20 mm



Füllungsinstrumente  
Filling Instruments  
Strumenti per otturazione  
Instrumentos para obturación  
Instruments pour obturation

Heidemann-Spateln  
Heidemann Spatulas  
Spatole Heidemann  
Espátulas Heidemann  
Spatules Heidemann



**NMI-H-1**  
Fig. 1

**NMI-H-2**  
Fig. 2

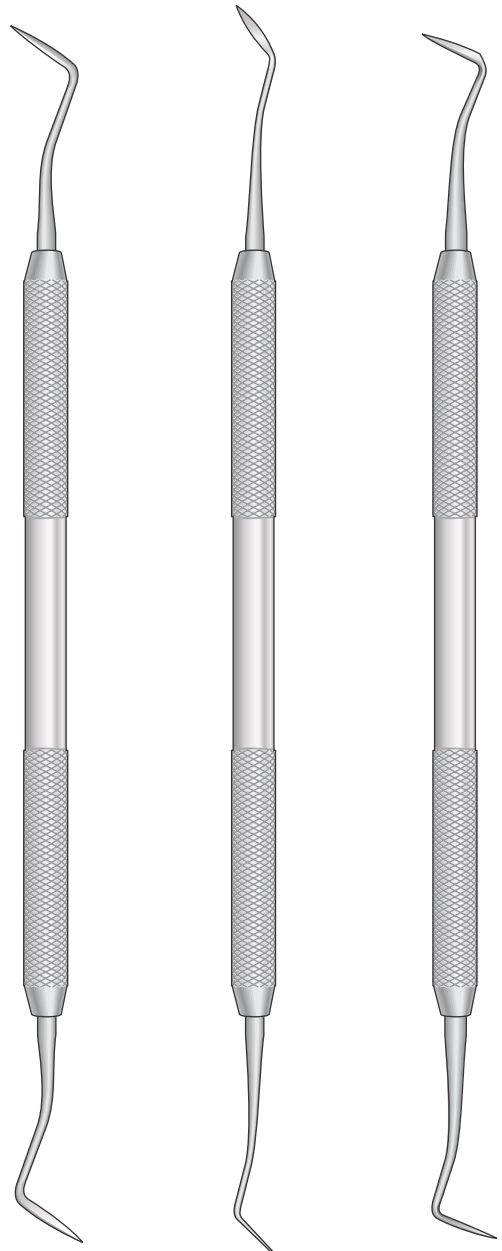
**NMI-H-3**  
Fig. 3

Dycal Applikator  
Placement Instrument  
Applicatore per sottofondo  
Aplicadores de fondo  
de cavidades  
Applicateur de fond  
de cavité



**NMI-A-1**  
125 mm

Amalgam Instrumente  
Amalgam Carvers  
Strumenti per modellare l'amalgama  
Instrumentos para modelar las obturaciones  
Instruments à modeler l'amalgame



**NMI-R-1**  
HOLLENBACH  
# 1 - 165 mm

**NMI-R-2**  
HOLLENBACH  
# 1/2 - 165 mm

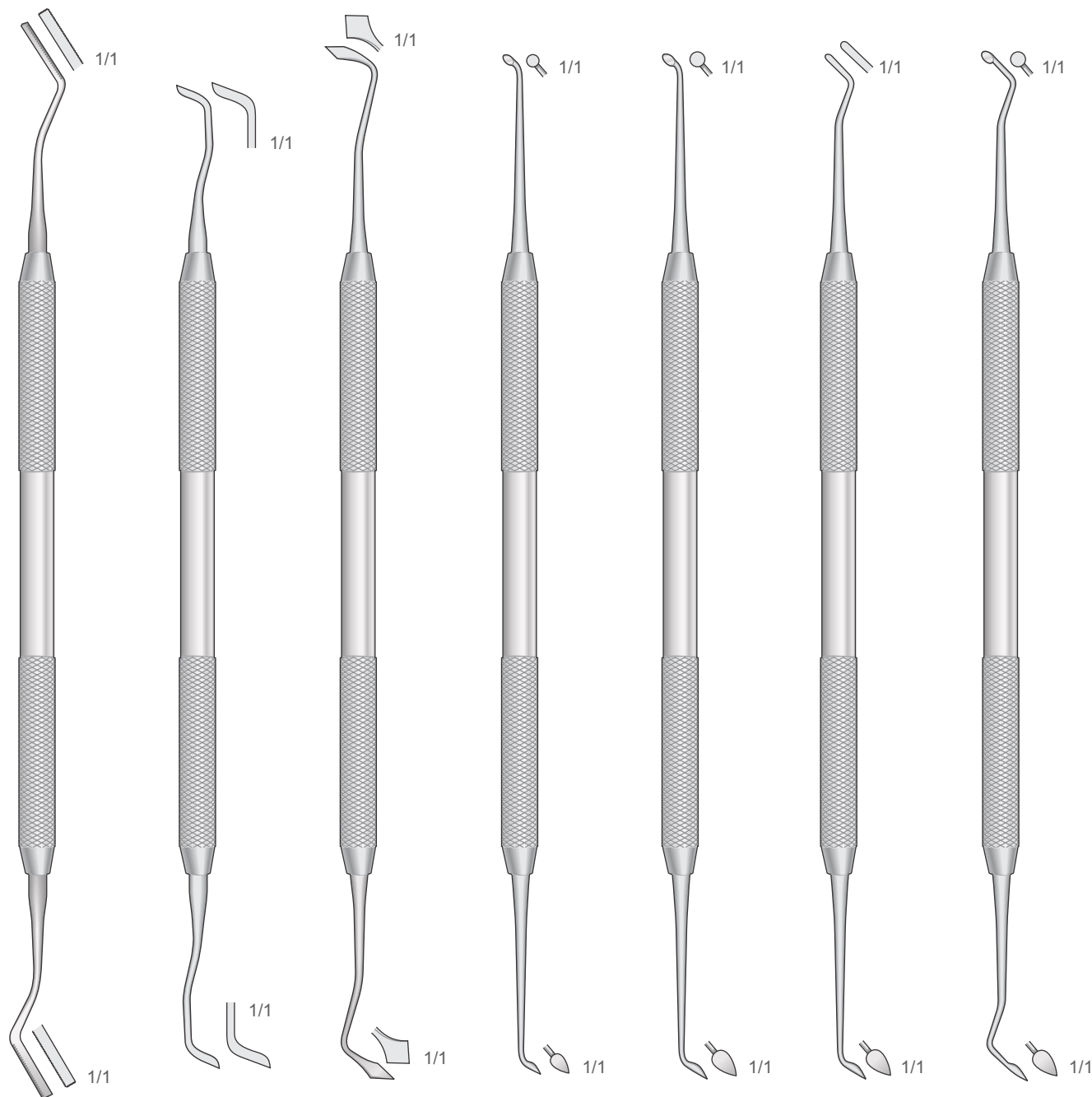
**NMI-R-3**  
HOLLENBACH  
# 3 - 165 mm



Amalgam Instrumente  
Amalgam Carvers  
Strumenti per modellare l'amalgama  
Instrumentos para modelar las obturaciones  
Instruments à modeler l'amalgame

Instrument für Drahrückzug  
Instrument for retractor wire  
Strumento per filo retrattore  
Instrumento para hilo separador  
Instruments pour fil séparateur

Cleoids - Discoids



**NMI-CV-11**  
A.C.D.

**NMI-NMI-USC-2**  
USC

**NMI-F-2/3**  
FRAHM

**NMI-CD-1V**  
Fig. 1/2

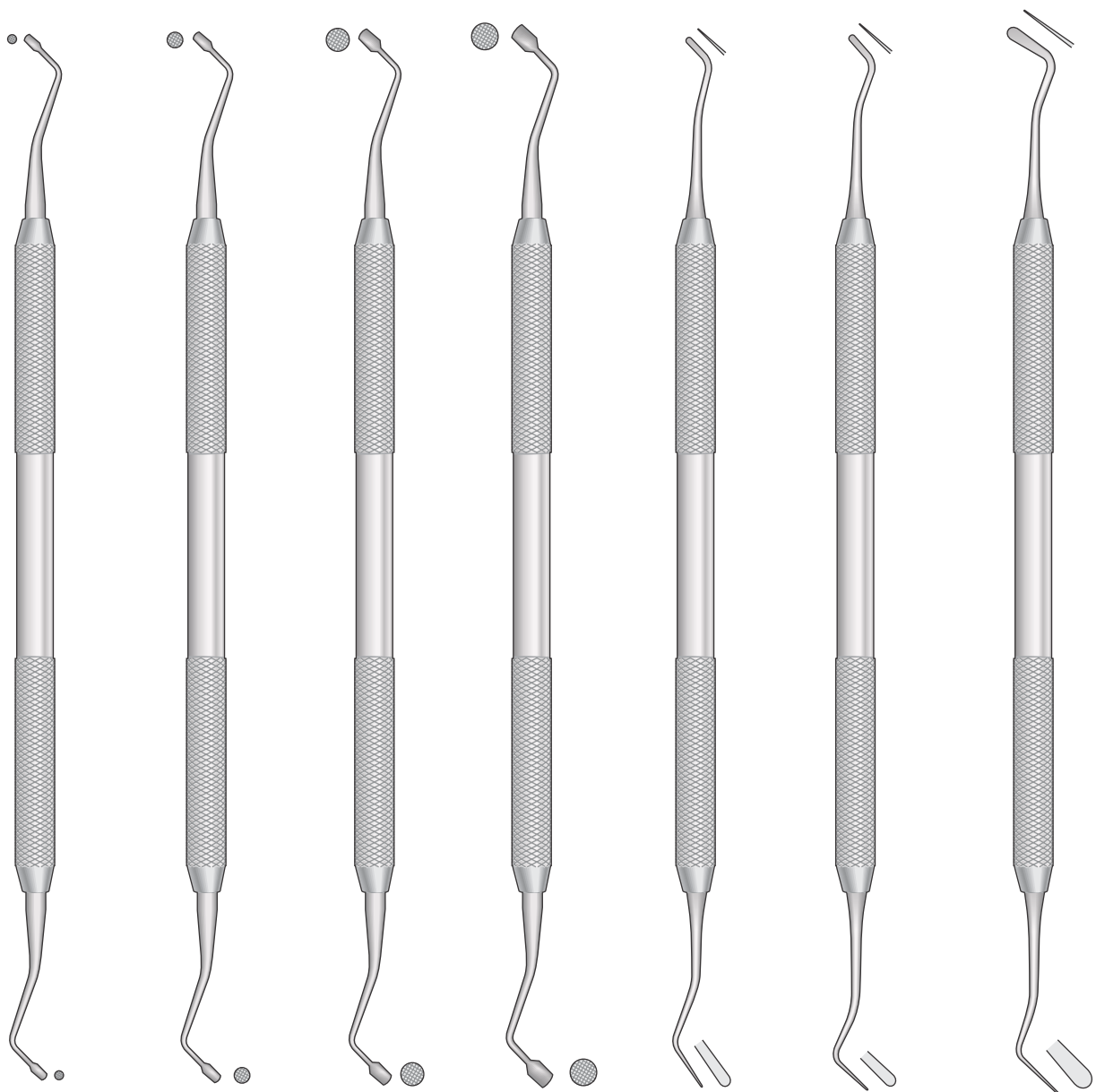
**NMI-CD-2**  
Fig. 4/5

**NMI-CD-3**  
Fig. W

**NMI-CD-4**  
Fig. 3/6



Füllungsinstrumente  
Filling Instruments  
Strumenti per otturazione  
Instrumentos para  
obturación Instruments pour  
obturation



NMI-O-1

NMI-O-2

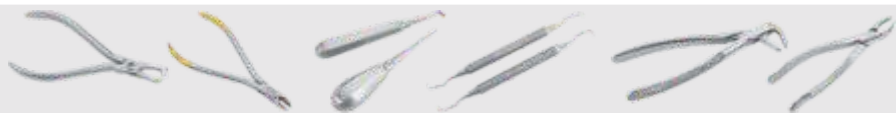
NMI-O-3

NMI-O-4

NMI-OK-1

NMI-OK-2

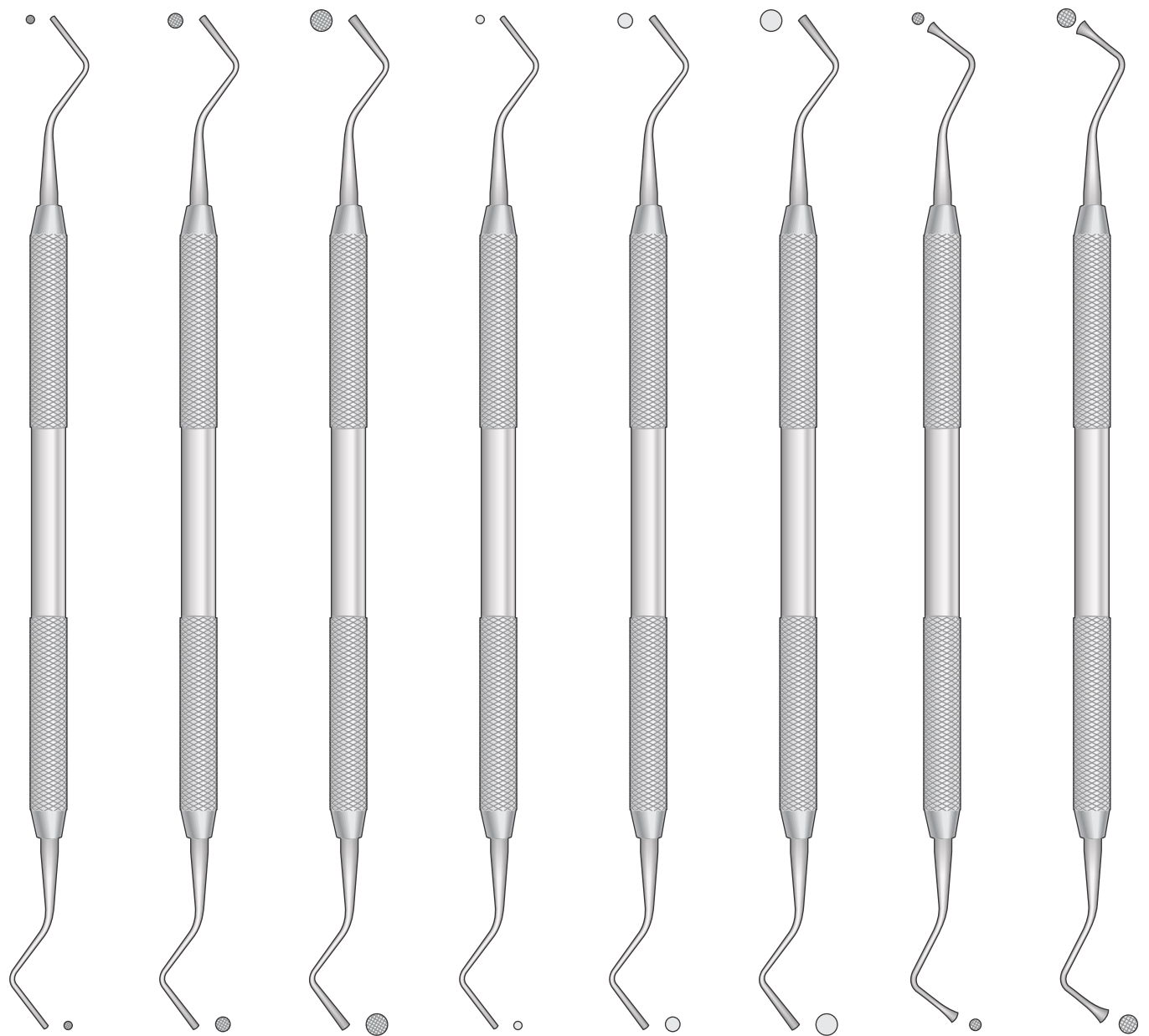
NMI-OK-3



Füllungsinstrumente  
Filling Instruments  
Strumenti per otturazione  
Instrumentos para obturación  
Instruments pour obturation

Gerieft  
Serrated  
Zigrinati  
Estriado  
s Striée

Glatt  
Smooth  
h Lisci  
Lisos  
Lissée



**NMI-OZ-1**  
Fig.1

**NMI-OZ-2**  
Fig.2

**NMI-OZ-3**  
Fig.3

**NMI-OL-1**  
Fig.1L

**NMI-OL-2**  
Fig.2L

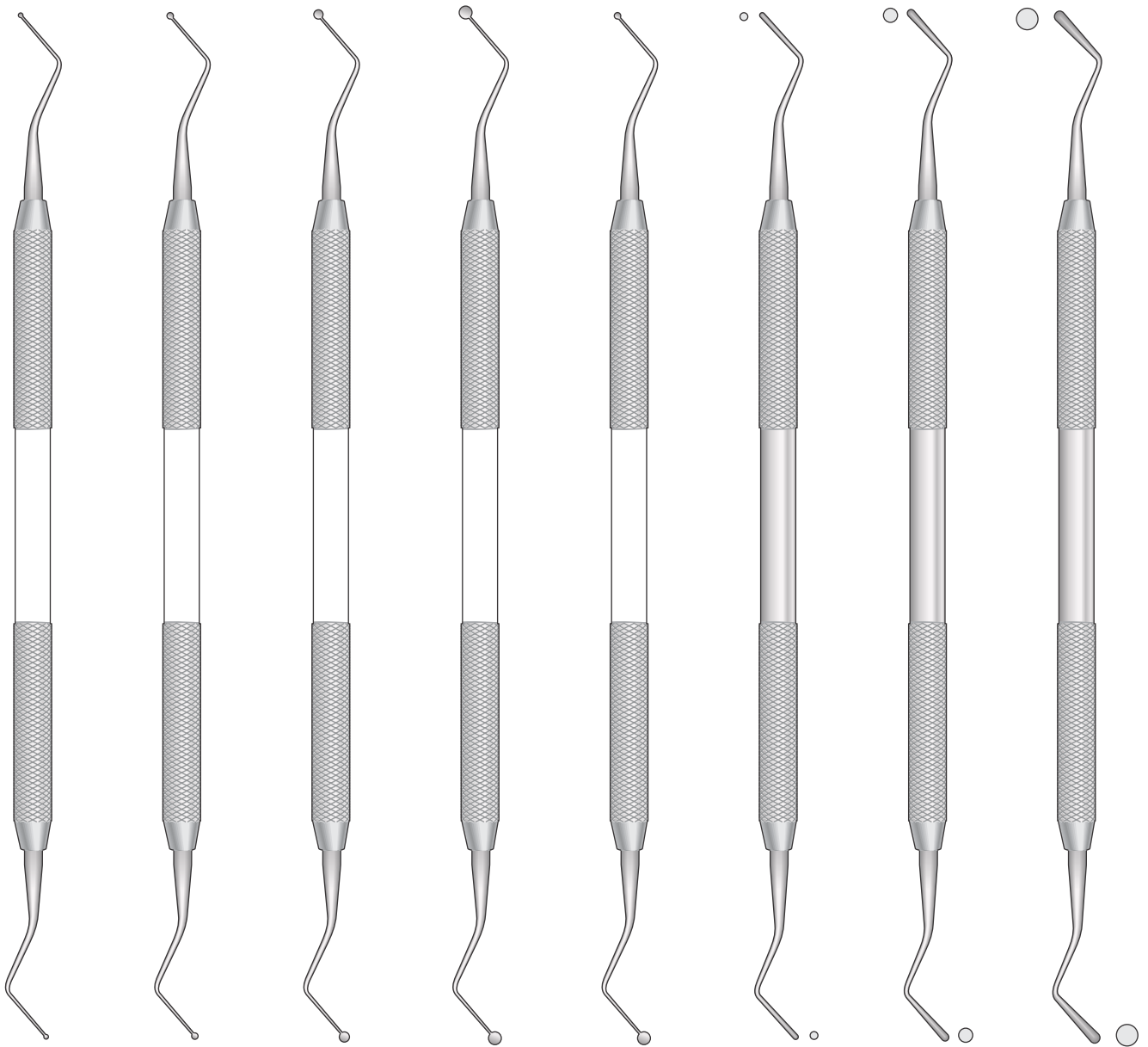
**NMI-OL-3**  
Fig.3L

**WARD  
NMI-OC-1**

**WARD  
NMI-OC-2**



Füllungsinstrumente  
Filling Instruments  
Strumenti per otturazione  
Instrumentos para  
obturación Instruments pour  
obturation



**NMI-OP-1**  
Fig.1

**NMI-OP-2**  
Fig.2

**NMI-OP-3**  
Fig.3

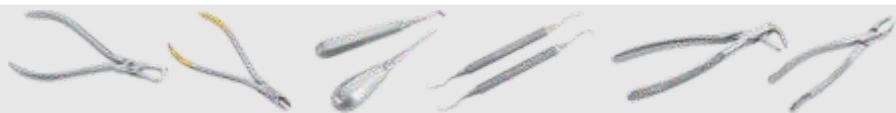
**NMI-OP-4**  
Fig.4

**NMI-OP-5**  
Fig.5

**NMI-OA-1**  
Fig.1

**NMI-OA-2**  
Fig.2

**NMI-OA-3**  
Fig.3



Füllungsinstrumente  
Filling Instruments  
Strumenti per otturazione  
Instrumentos para obturación  
Instruments pour obturation



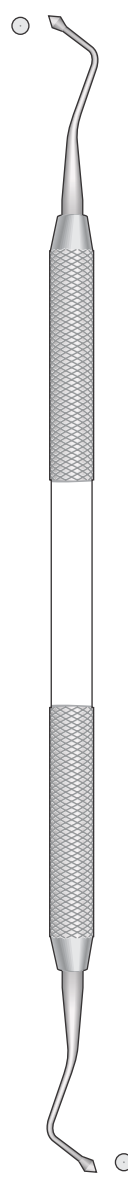
NMI-OX-1



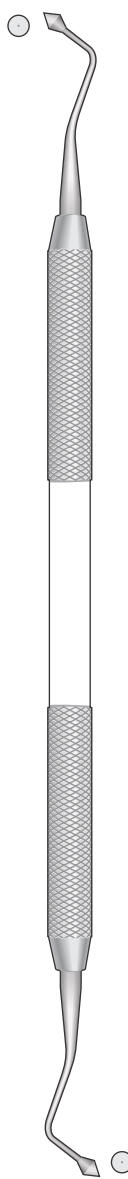
NMI-OX-2



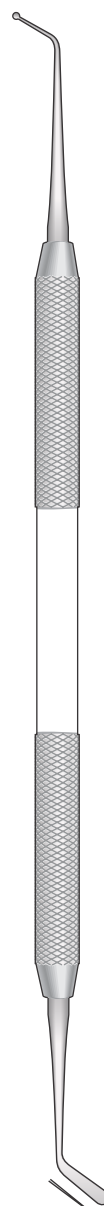
NMI-OX-3



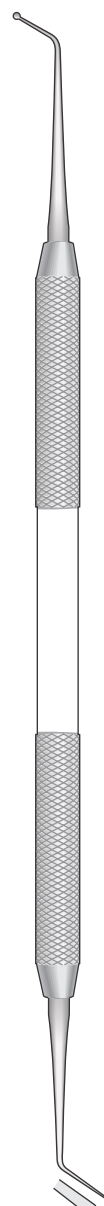
WESTCOTT  
NMI-OS-1



WESTCOTT  
NMI-OS-2



NMI-OM-2



NMI-ON-1



Restaurative Zahnheilkunde  
Dental Restoration  
Odontoiatria conservativa  
Odontología conservadora  
Odontologie conservatrice

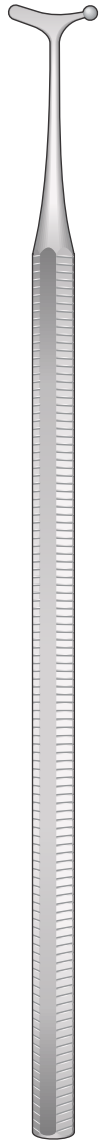
Füllungsinstrumente  
Filling Instruments  
Strumenti per otturazione  
Instrumentos para obturación  
Instruments pour obturation



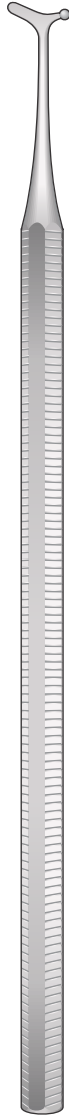
WHITE  
NMI-B-3  
n°28



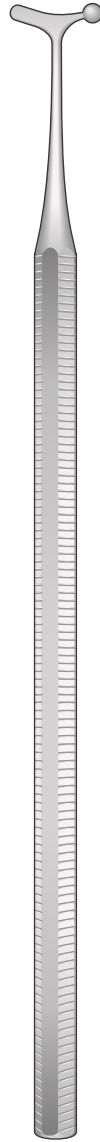
WHITE  
NMI-B-4  
n°29



WHITE  
NMI-B-32  
n°32



WHITE  
NMI-B-33  
n°33



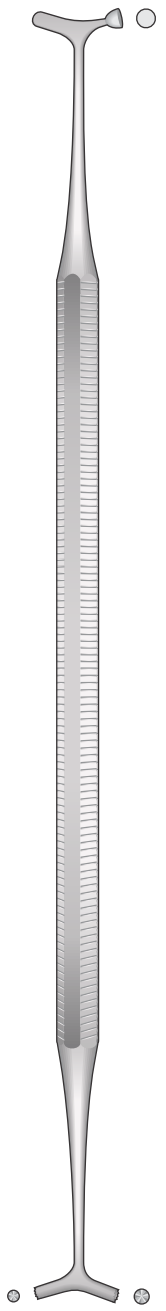
WHITE  
NMI-B-34  
n°34



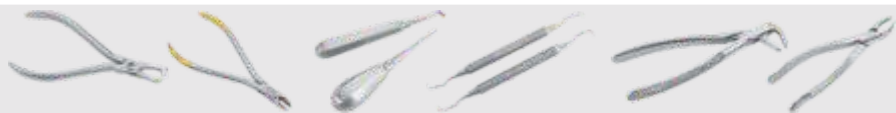
WHITE  
NMI-B-28/29  
Doppio



WHITE  
NMI-B-31/32  
Doppio

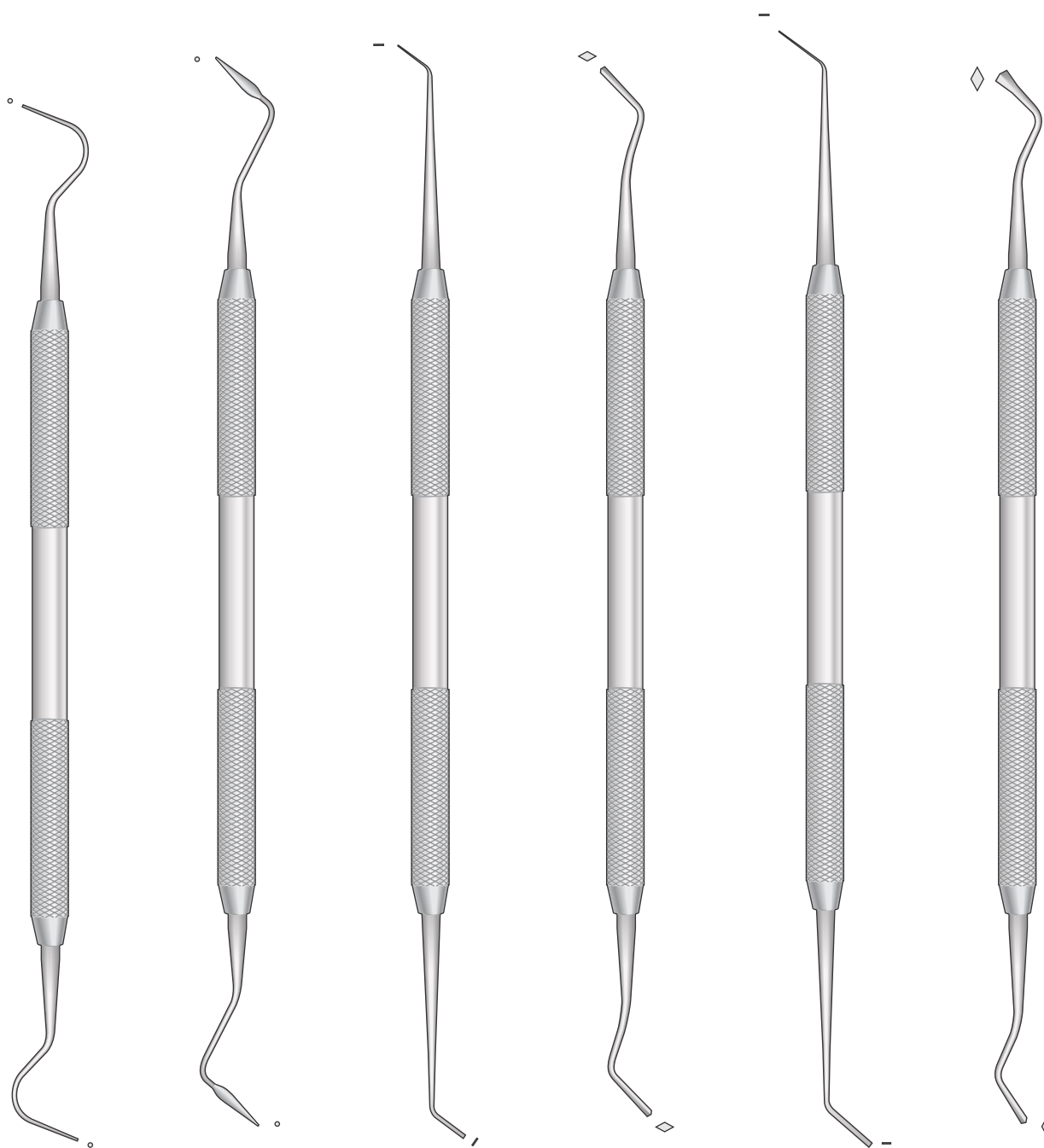


BENNET  
NMI-B-35  
170 mm



Füllungsinstrumente  
Filling Instruments  
Strumenti per otturazione  
Instrumentos para obturación  
Instruments pour obturation

**MARKLEY PLUGGERS**  
Amalgam Instrumente  
Amalgam Instruments  
Strumenti per amalgama  
Instrumentos para  
amalgama Instruments à  
amalgame



**NMI-PM-1**  
Fig.1M

**NMI-PM-2**  
Fig.2M

**NMI-PM-3**  
Fig.3M

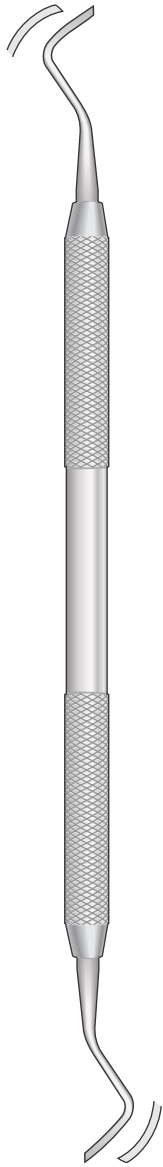
**NMI-PM-4**  
Fig.4M

**NMI-PM-5**  
Fig.5M

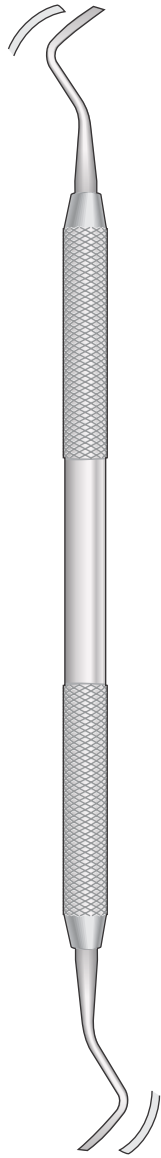
**NMI-PM-6**  
Fig.6M



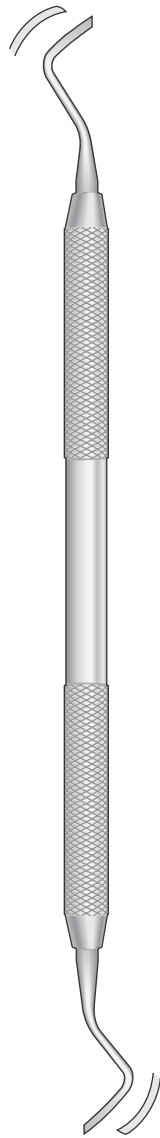
Schmelzinstrumente  
Enamel Instruments  
Strumenti da smalto  
Instrumentos para esmalte  
Instruments à émail



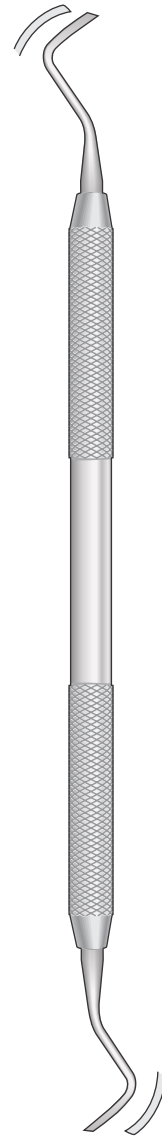
**BLACK  
NMI-TS-1**  
Fig.26



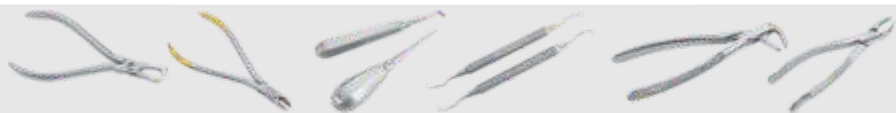
**BLACK  
NMI-TS-2**  
Fig.27



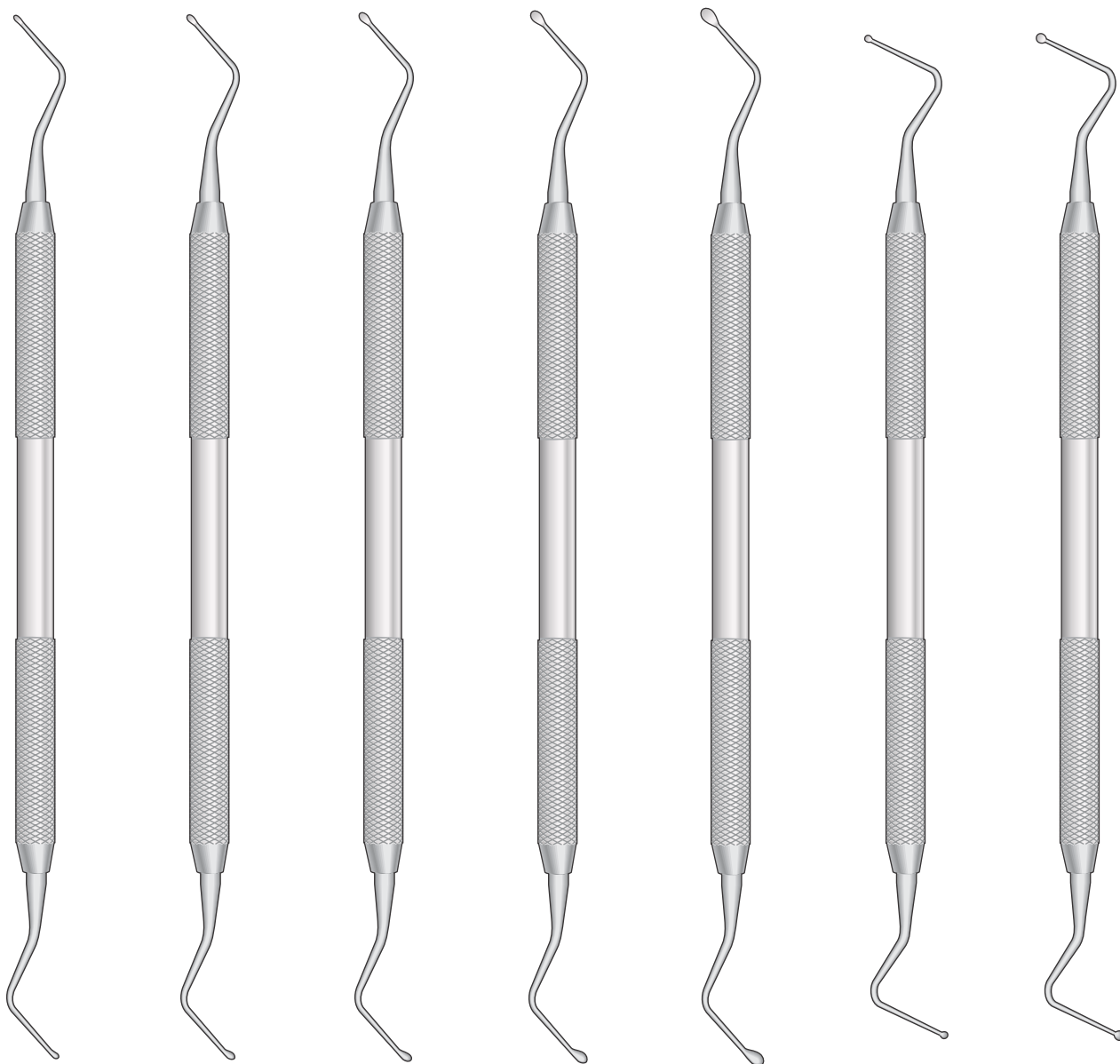
**BLACK  
NMI-TS-3**  
Fig.28



**BLACK  
NMI-TS-4**  
Fig.29



Excavatoren  
Excavators  
Escavatori  
Excavadores  
Excavateurs



**NMI-E-0**  
Fig.0

**NMI-E-1**  
Fig.1

**NMI-E-2**  
Fig.2

**NMI-E-3**  
Fig.3

**NMI-E-4**  
Fig.4

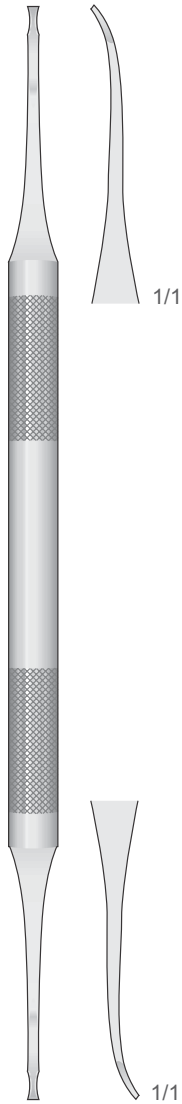
**NMI-EC-1**  
Fig.1

**NMI-EC-2**  
Fig.2



Meißel für  
Parodontologie  
Periodontal Chisels  
Scalpelli parodontali  
Cinceles periodontales  
Burins parodontaux

Fig. 1



**FEDI  
NMI-OF-1**  
175 mm

Fig. 2



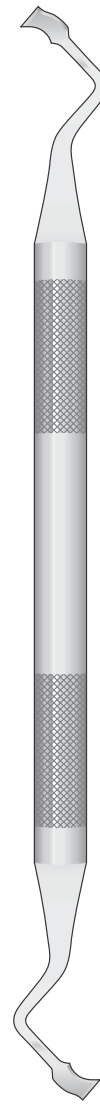
**FEDI  
NMI-OF-2**  
175 mm

Fig. 3

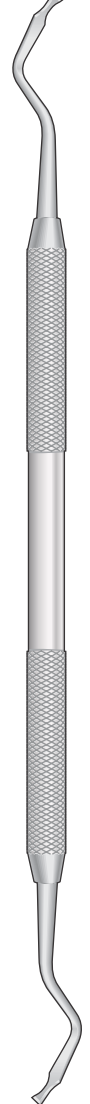


**FEDI  
NMI-OF-3**  
170 mm

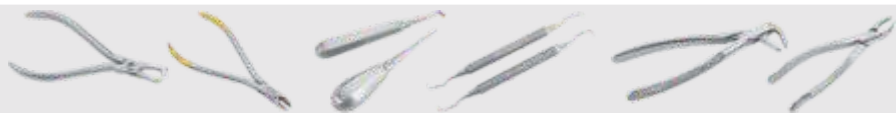
Fig. 4



**OCHSENBEIN  
NMI-OSB-4A**  
170 mm



**NMI-OSB-4**  
170 mm

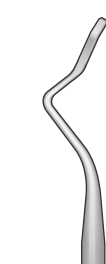


Meißel für Parodontologie  
Periodontal Chisels  
ScalPELLI parodontali  
Cinceles periodontales  
Burins parodontaux

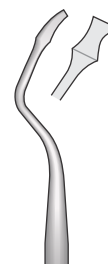
Bevel IN  
Fig.1



Bevel OUT  
Fig.2



OCHSENBEIN-3  
NMI-718-103



OCHSENBEIN-4  
NMI-718-104



RHODES BACK ACTION  
NMI-718-107



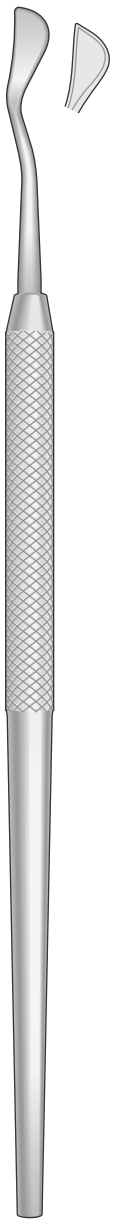
OCHSENBEIN-1  
NMI-OSB-1  
165 mm

OCHSENBEIN-2  
NMI-OSB-2  
165 mm

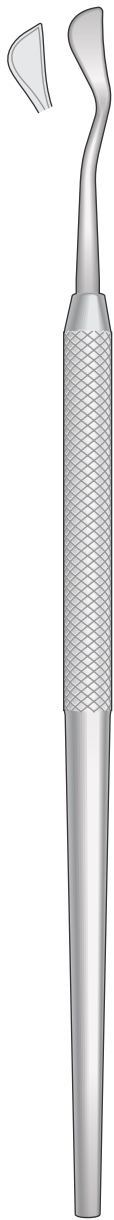
TG CHISELS  
NMI-718-113



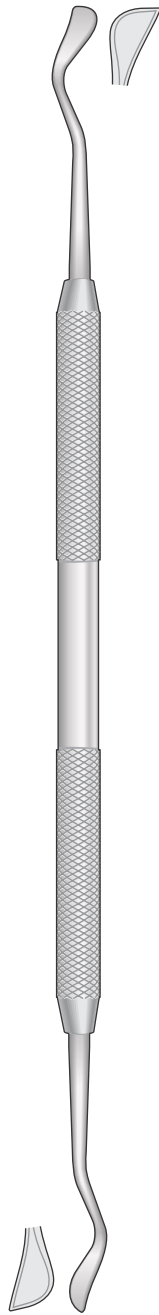
Parodontalmesser  
Gingivectomy Knives  
Bisturi per gengivectomia  
Bisturías para la gengivectomía  
Bistouris pour la gengivectomie



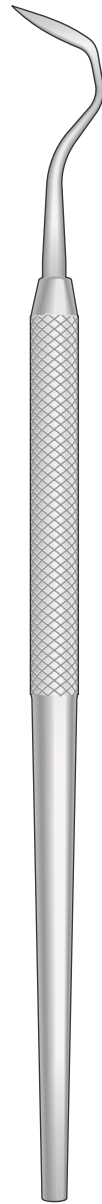
**KIRKLAND  
NMI-KKD-1**  
Fig.15K



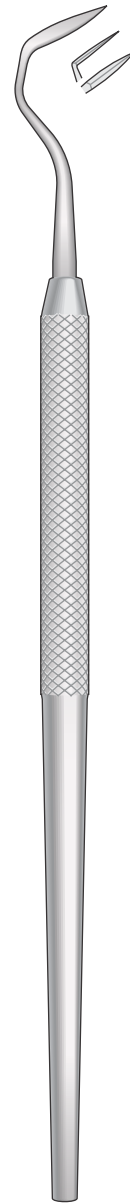
**KIRKLAND  
NMI-KKD-2**  
Fig.16K



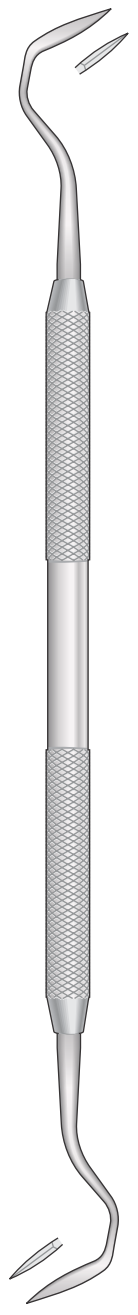
**KIRKLAND  
NMI-KKD-4**  
Fig.15K - Fig.16K



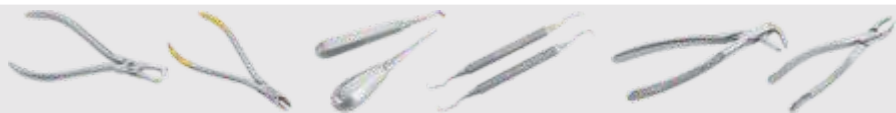
**ORBAN  
NMI-OBN-1**  
Fig.1



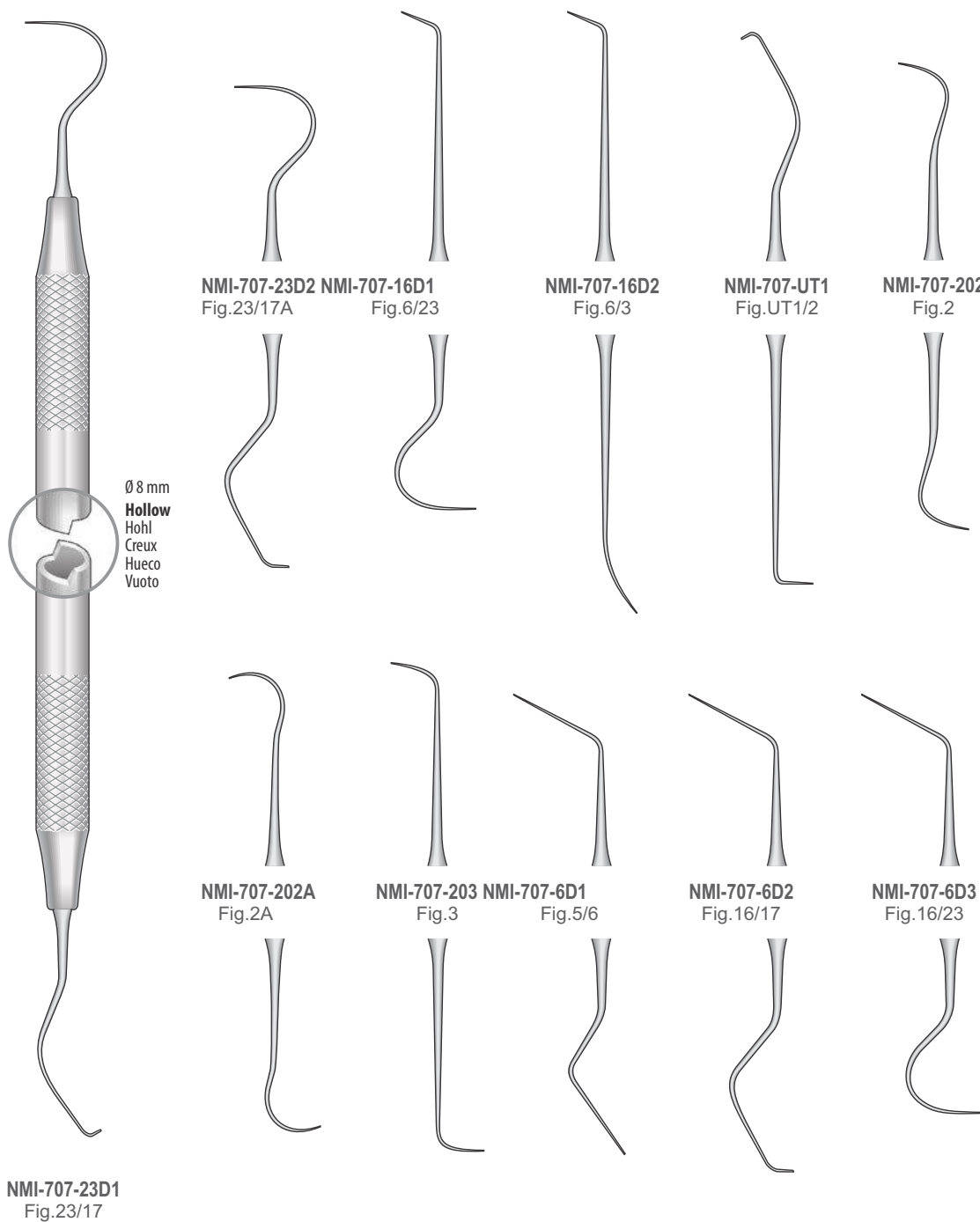
**ORBAN  
NMI-OBN-2**  
Fig.2

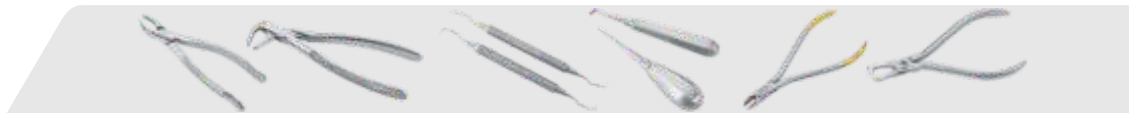


**ORBAN  
NMI-OBN-4**  
Fig.1 - Fig.2

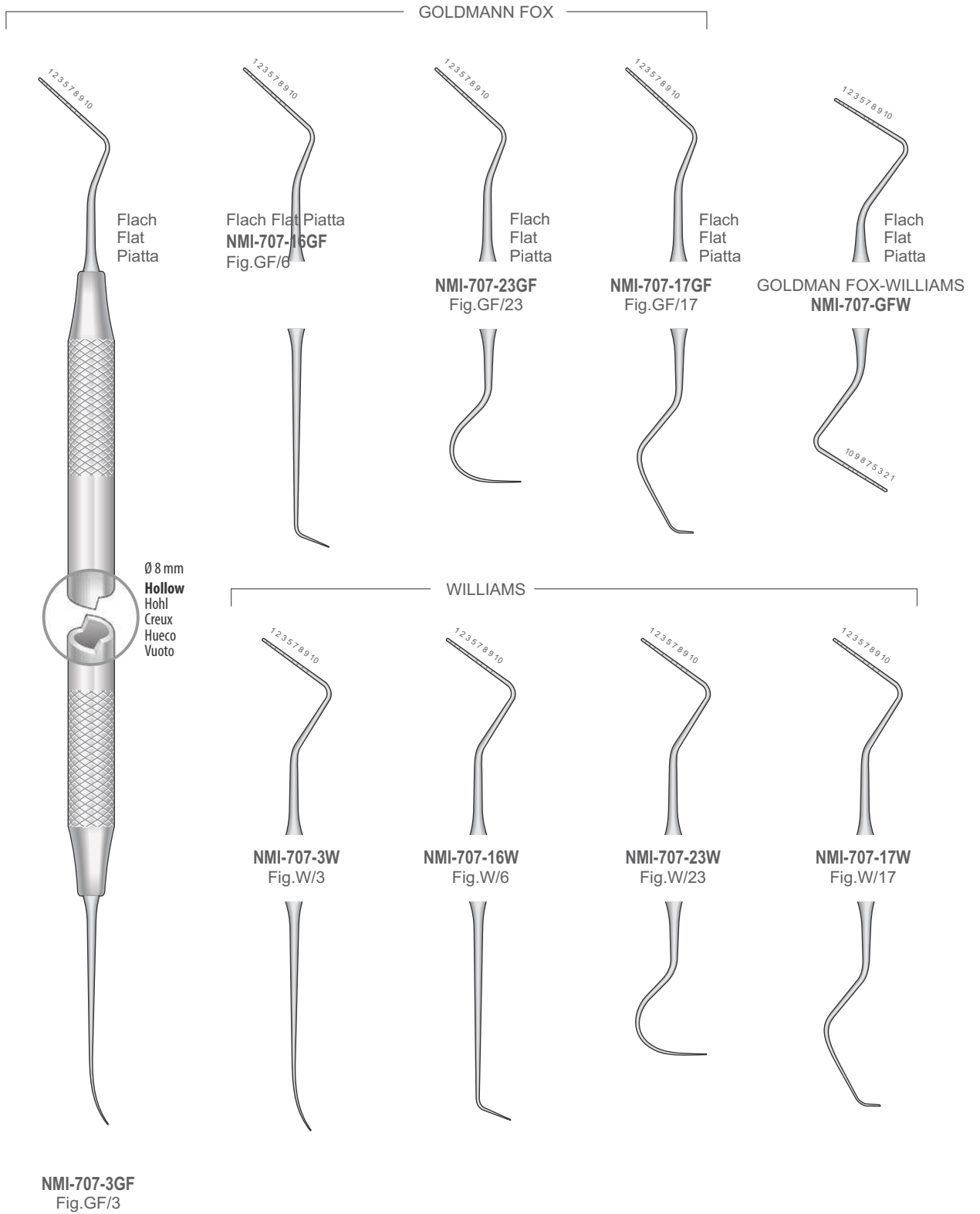


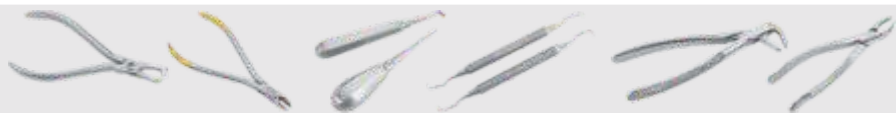
Doppelendiger Zahnsonden  
Double-ended Explorer  
Sonda falce doppia Sonda  
exploradora doble Sonda  
exploratrice double





Doppelendiger Parodontometer  
Double-ended Periodontal  
Probes Sondes parodontales  
dobles Sonde parodontali doppie  
Sondas parodontales doubles





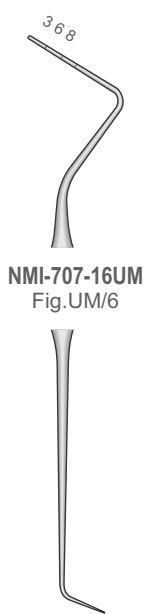
Doppelendiger Parodontometer  
Double-ended Periodontal Probes  
Sondes parodontales doubles  
Sonde parodontali doppie  
Sondas parodontales dobles

UNIVERSITY OF MICHIGAN

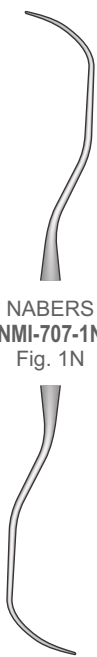


**NMI-707-3UM**  
Fig.UM/3

Ø 8 mm  
**Hollow**  
Hohl  
Creux  
Hueco  
Vuoto



**NMI-707-16UM**  
Fig.UM/6



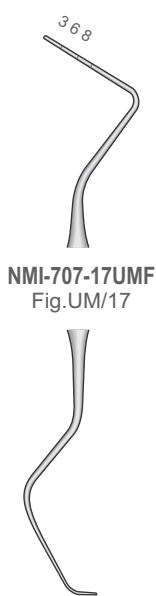
**NABERS  
NMI-707-1N**  
Fig. 1N



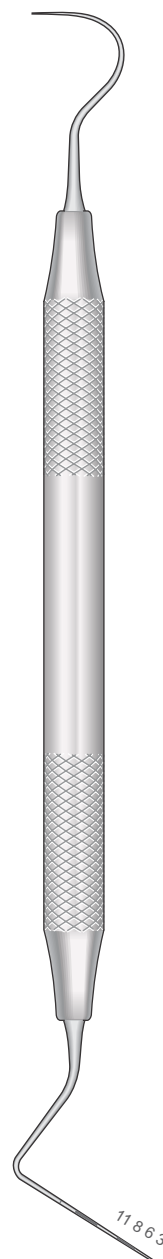
**NMI-707-23UM**  
Fig.UM/23



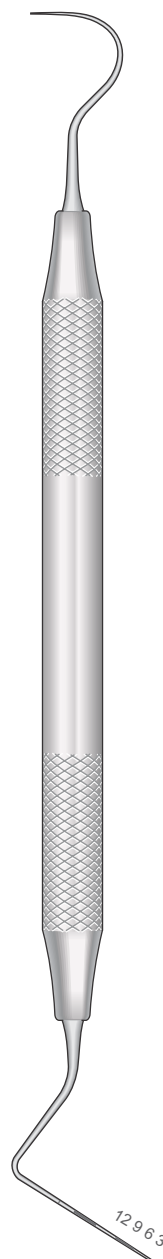
**NABERS  
NMI-707-2N**  
Fig. 2N



**NMI-707-17UMF**  
Fig.UM/17



**NMI-707-2311**  
Fig.CP11/23

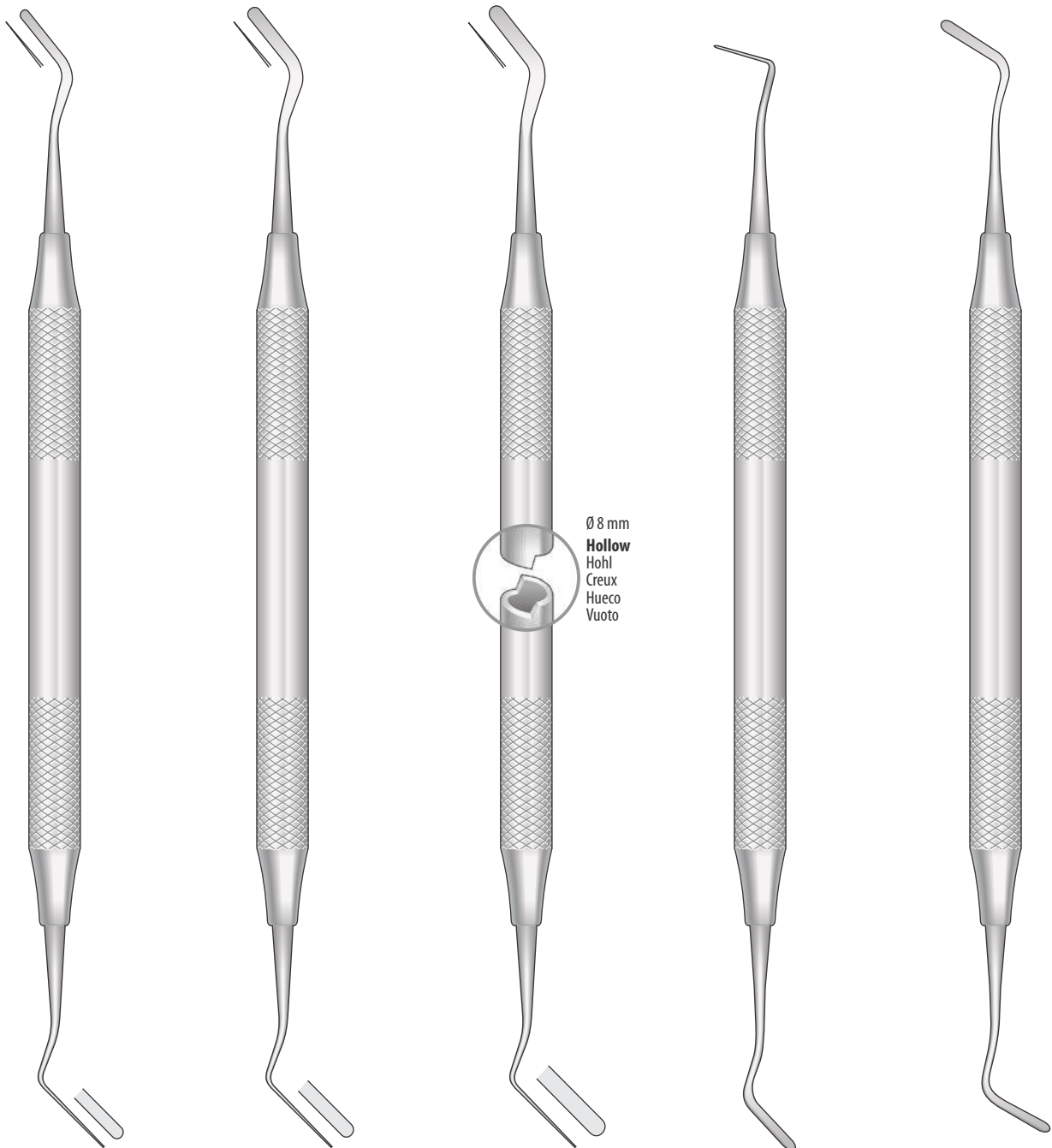


**NMI-707-2312**  
Fig.CP12/23



Spateln - Füllungsinstrumente  
Spatulas - Filling Instruments  
Spatole - Strumenti per otturazione  
Espátulas - Instrumentos para obturación  
Spatules - Instruments pour obturation

Heidemann Spateln  
Heidemann Spatulas  
Spatole Heidemann  
Espátulas Heidemann  
Spatules Heidemann



Ø 8 mm  
**Hollow**  
Hohl  
Creux  
Hueco  
Vuoto

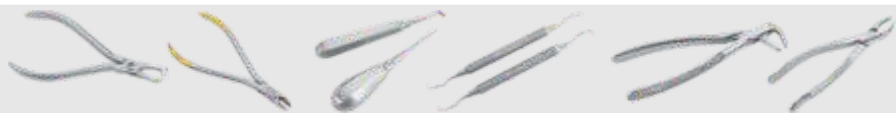
HEIDEMANN  
NMI-711-301  
Fig.1

HEIDEMANN  
NMI-711-302  
Fig.2

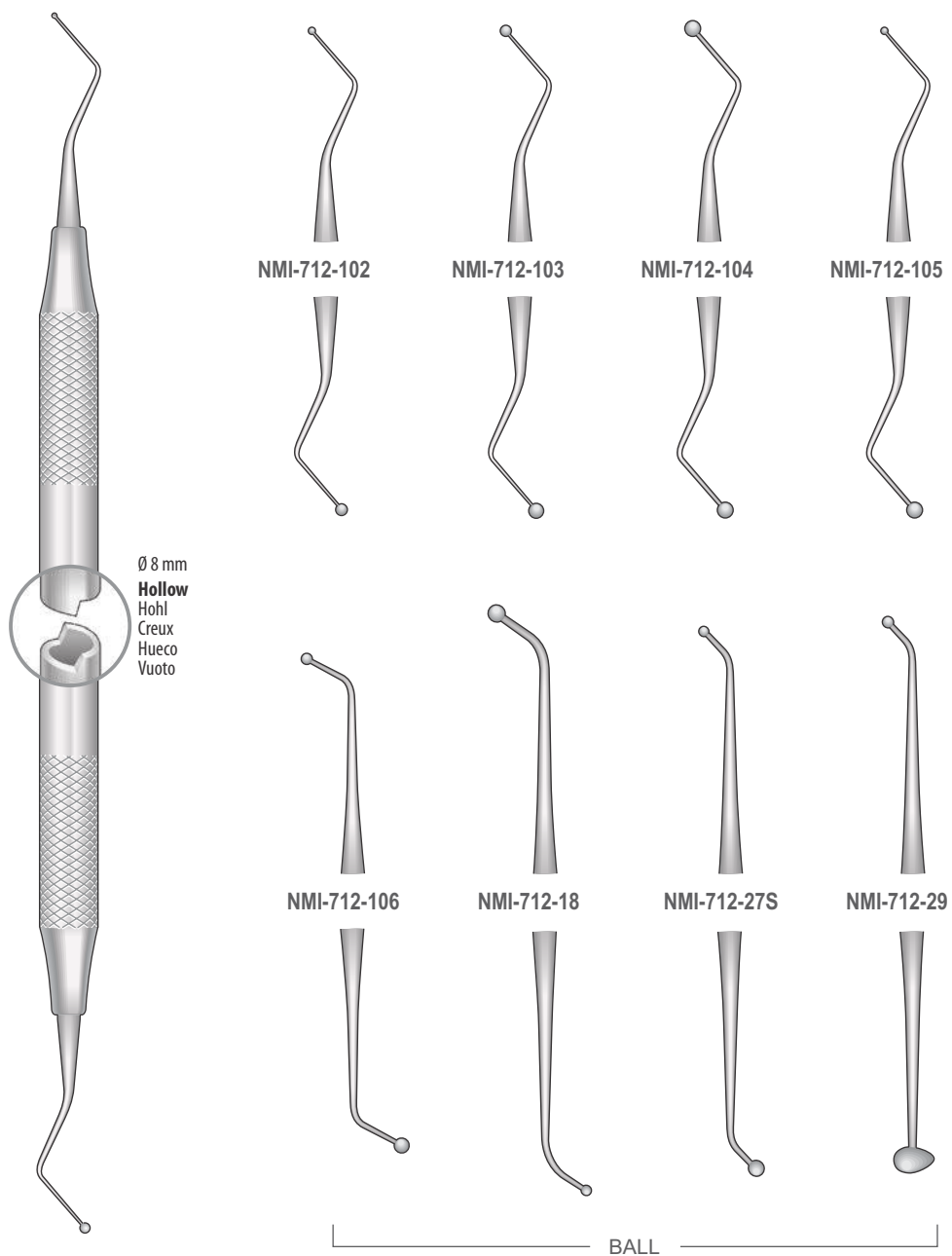
HEIDEMANN  
NMI-711-303  
Fig.3

IPC Fig. 1  
NMI-715-311  
Interproximal

IPC/OA Fig. 2  
NMI-715-312  
Interproximal Off-Angle



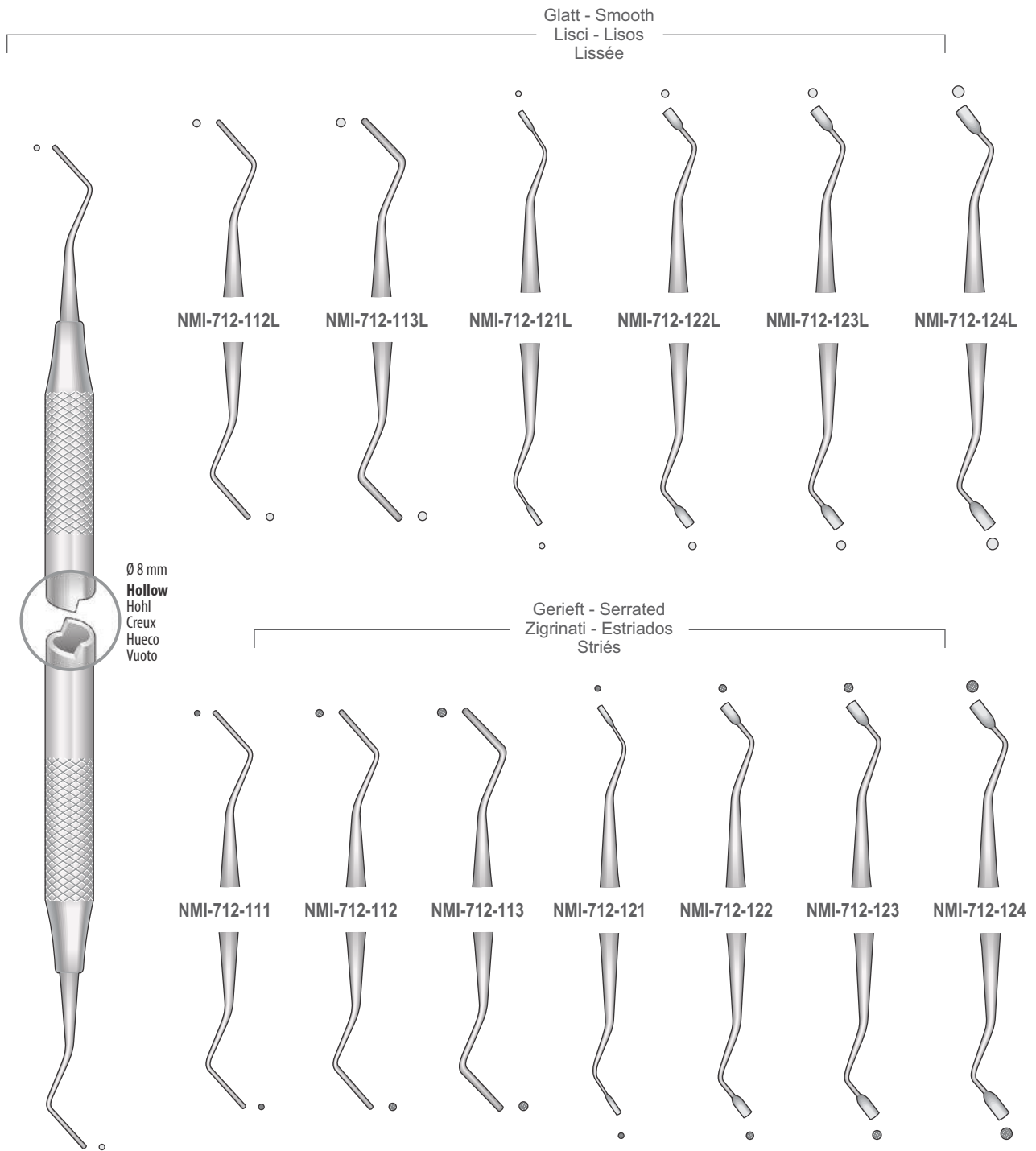
Füllungsinstrumente  
Filling Instruments  
Strumenti per otturazione  
Instrumentos para obturación  
Instruments pour obturation



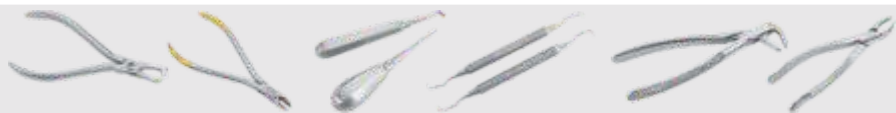
NMI-712-101



Füllungsinstrumente  
Filling Instruments  
Strumenti per otturazione  
Instrumentos para obturación  
Instruments pour obturation



NMI-712-111L



Füllungsinstrumente  
Filling Instruments  
Strumenti per otturazione  
Instrumentos para obturación  
Instruments pour obturation

HOLLENBACK



Ø 8 mm  
**Hollow**  
Hohl  
Creux  
Hueco  
Vuoto

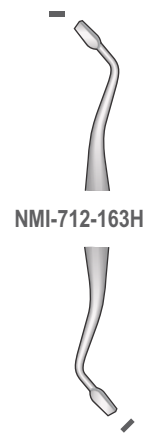
**NMI-712-PFI**  
170 mm



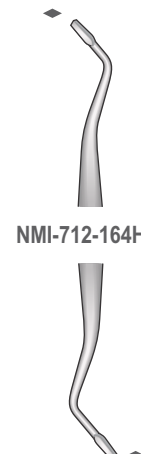
**NMI-712-161H**



**NMI-712-162H**



**NMI-712-163H**



**NMI-712-164H**

MARKLEY PLUGGERS



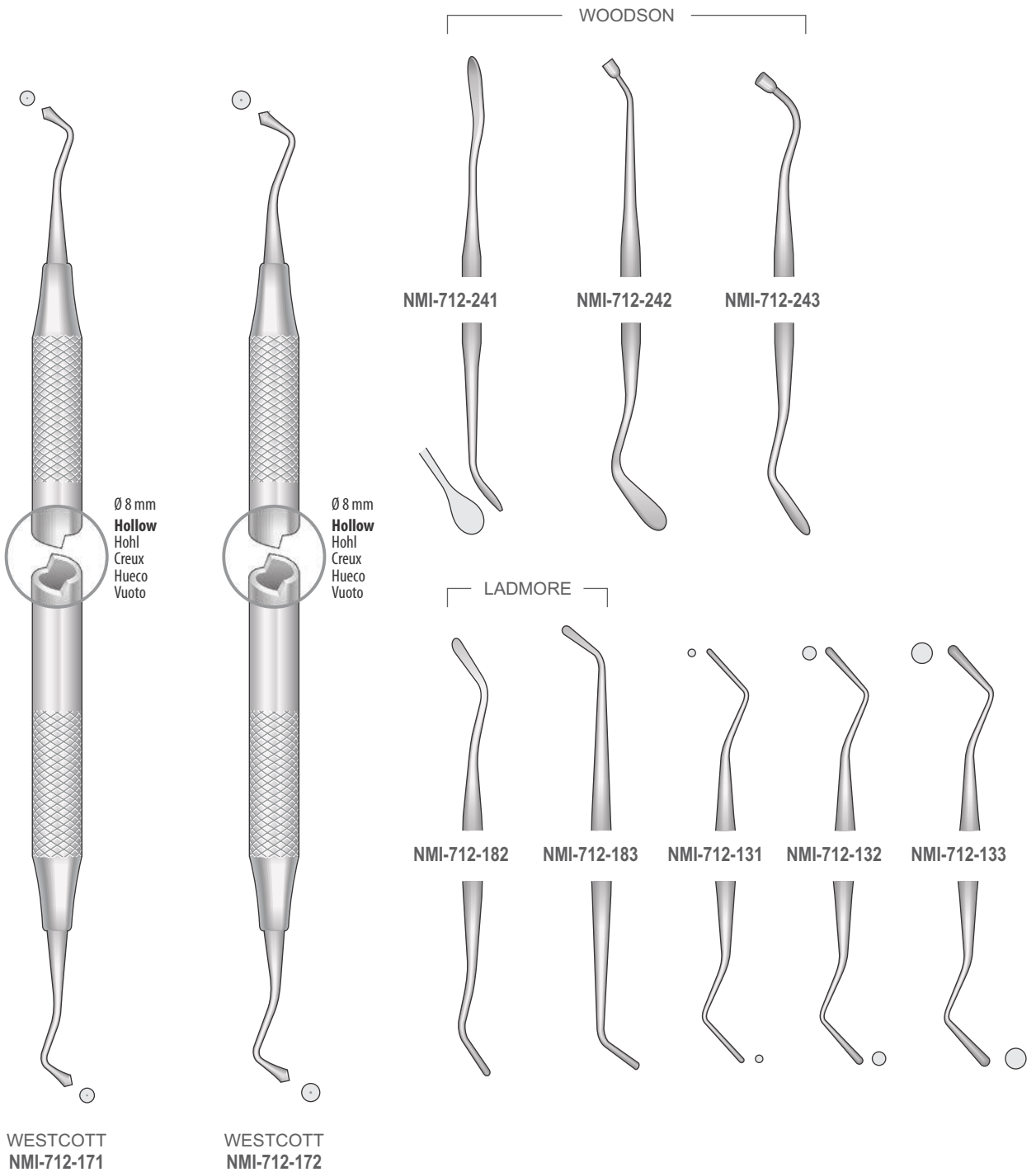
**NMI-714-101**

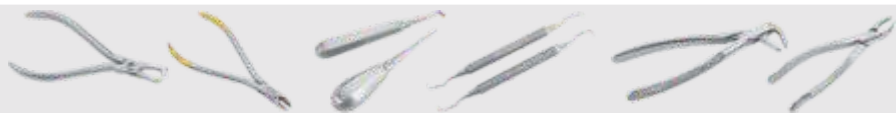


**NMI-714-102**

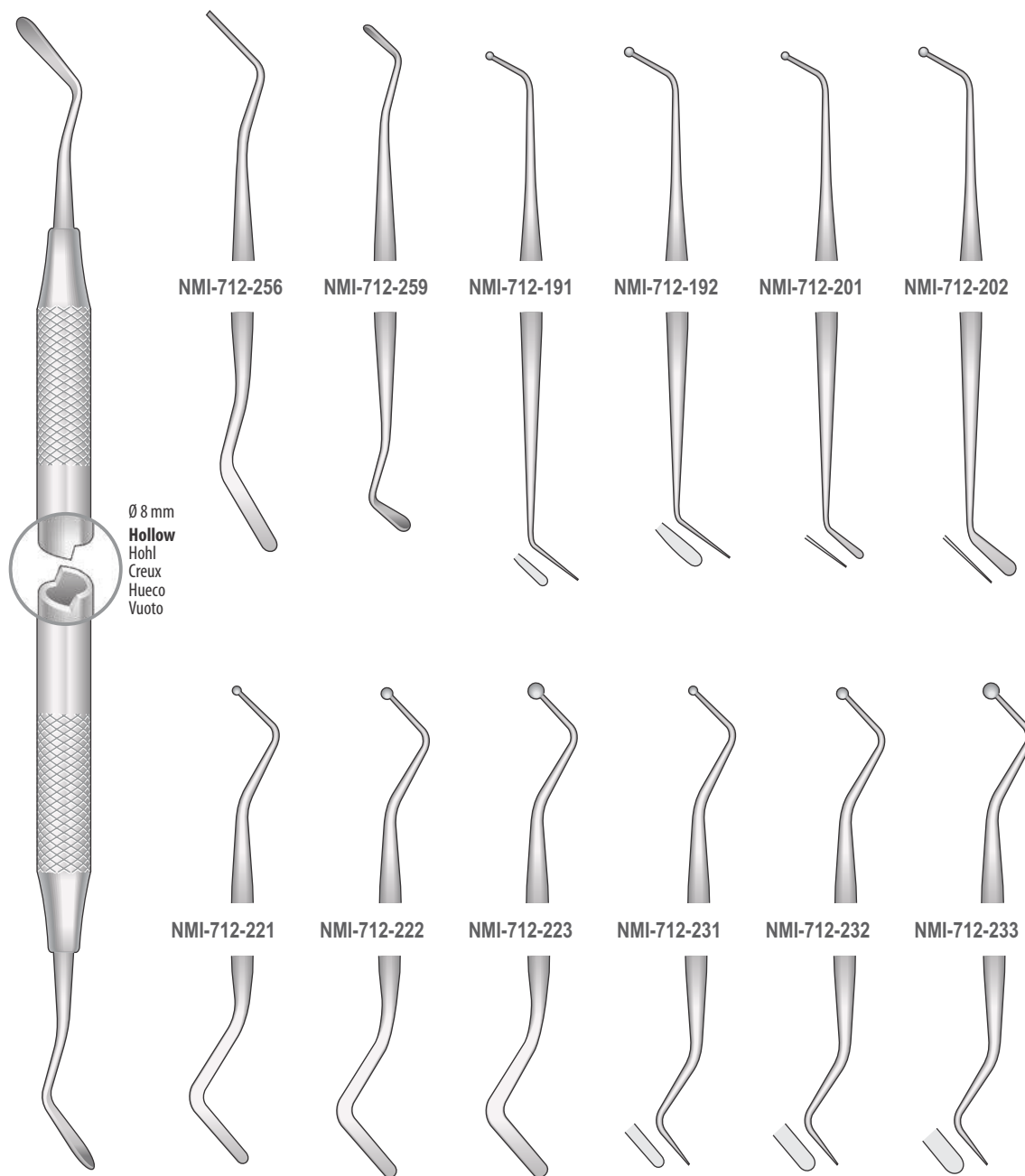


Füllungsinstrumente  
Filling Instruments  
Strumenti per otturazione  
Instrumentos para obturación  
Instruments pour obturation





Füllungsinstrumente  
Filling Instruments  
Strumenti per otturazione  
Instrumentos para obturación  
Instruments pour obturation



Ø 8 mm  
**Hollow**  
Hohl  
Creux  
Hueco  
Vuoto

NMI-712-251

NMI-712-256

NMI-712-259

NMI-712-191

NMI-712-192

NMI-712-201

NMI-712-202

NMI-712-221

NMI-712-222

NMI-712-223

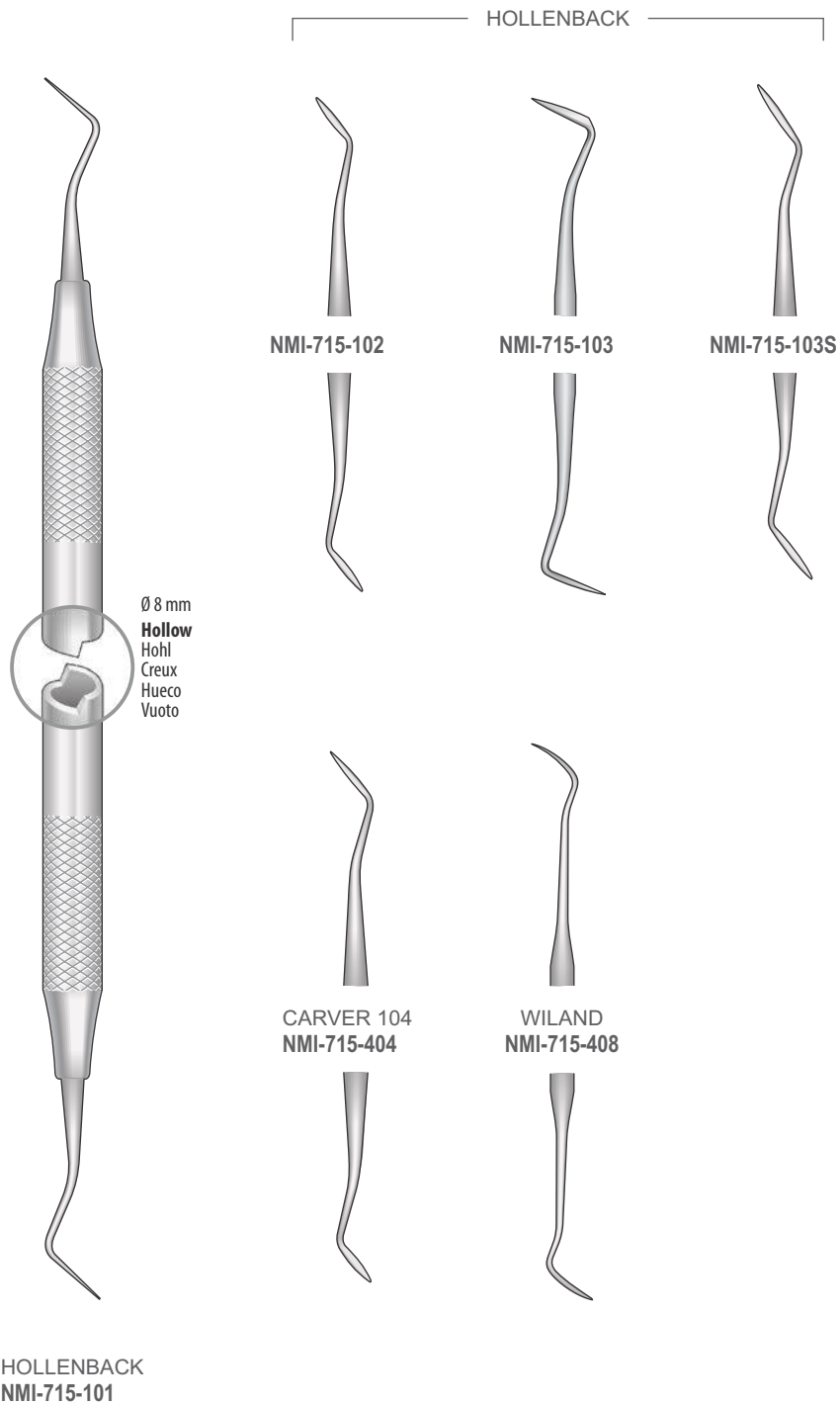
NMI-712-231

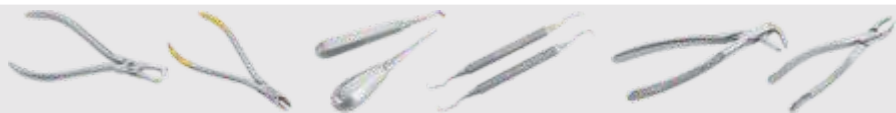
NMI-712-232

NMI-712-233

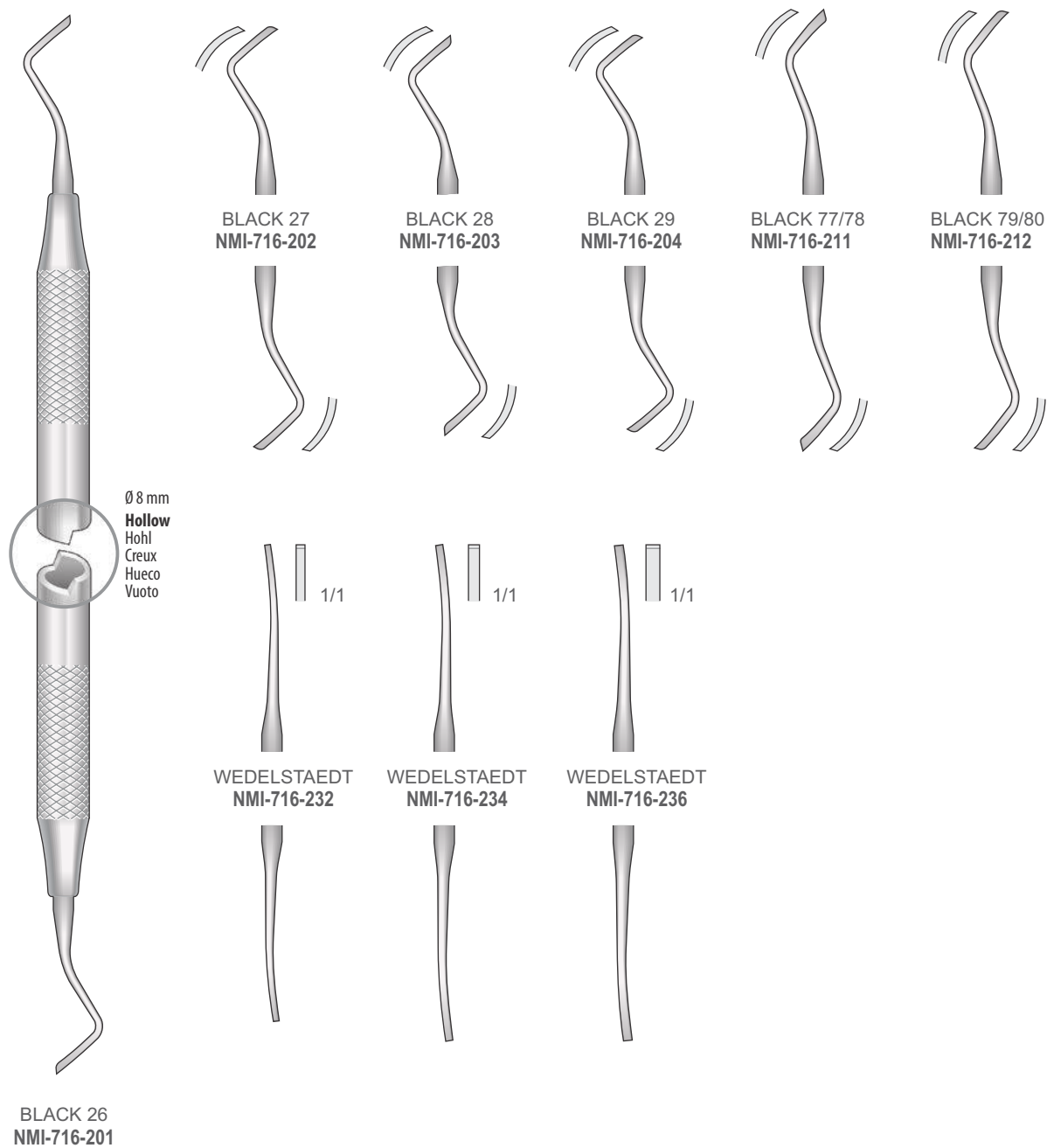


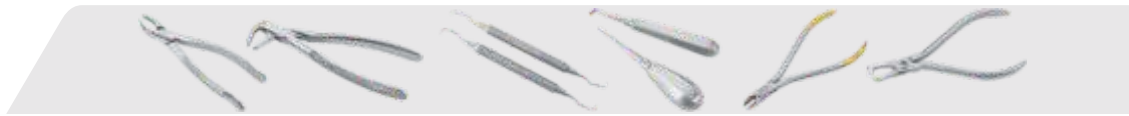
Amalgam Instrumente  
Amalgam carvers  
Strumenti per modellare otturazioni  
Instrumentos para modelar las  
obturaciones Instruments à modeler les  
obturations





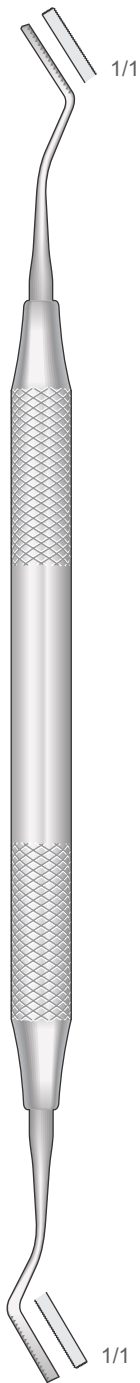
Schmelzinstrumente  
Cavity preparation instruments  
Strumenti da smalto  
Instrumentos para esmalte  
Instruments à émail





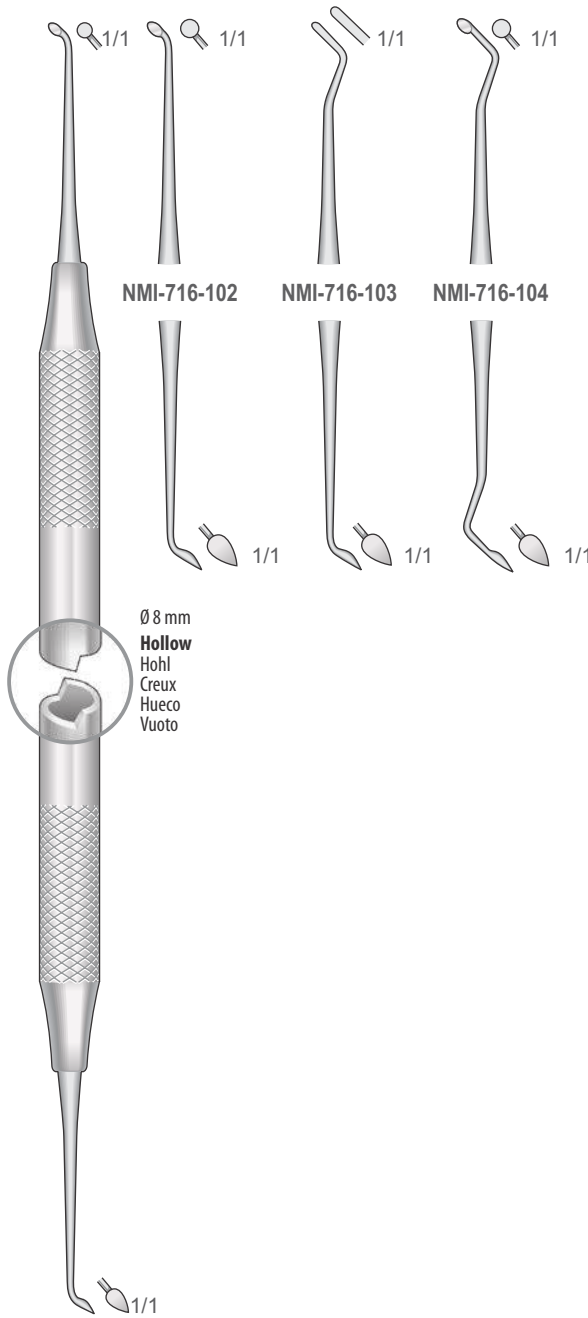
Amalgam Instrumente  
Amalgam carvers  
Strumenti per modellare otturazioni  
Instrumentos para modelar las obturaciones  
Instruments à modeler les obturations

Instrument für Drahrückzug  
Instrument for Retractor wire  
Strumento per filo retrattore  
Instrumento para hilo retractor  
Instruments pour fil rattracteur



NMI-714-CV11

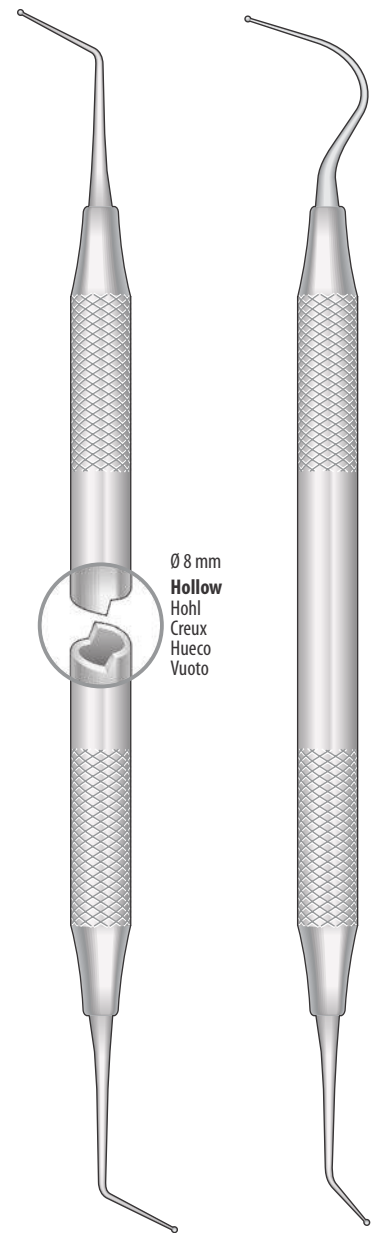
Cleoids - Discoids



Ø 8 mm  
**Hollow**  
Hohl  
Creux  
Hueco  
Vuoto

NMI-716-101

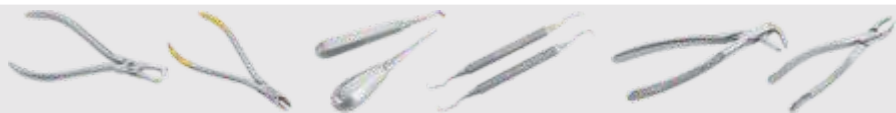
Dykal Applikator  
Placement Instruments  
Applicatori per sottofondo  
Aplicadores de fondo de cavidades  
Applicateurs de fond de cavité



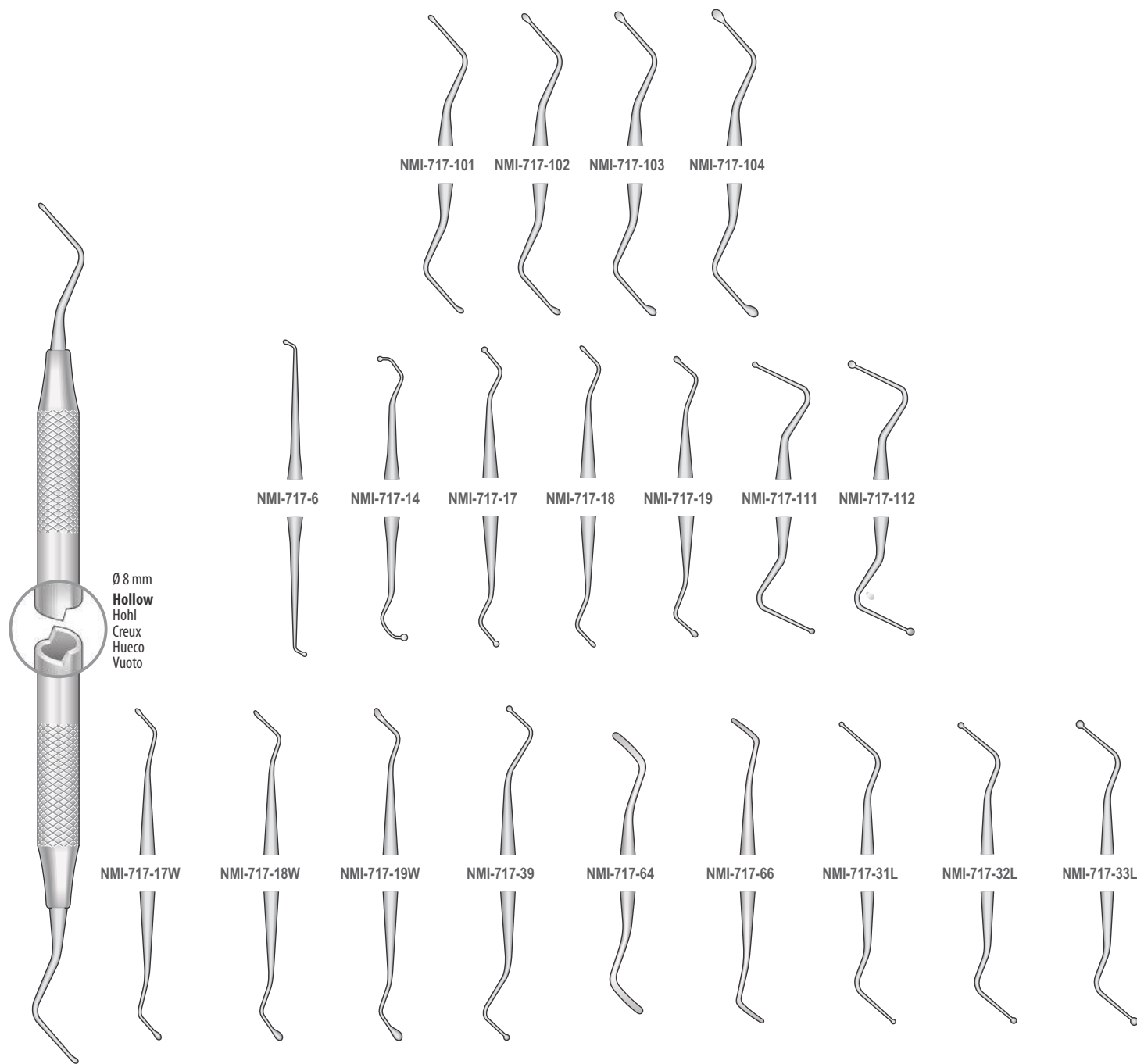
Ø 8 mm  
**Hollow**  
Hohl  
Creux  
Hueco  
Vuoto

NMI-713-101

NMI-713-102



Excavatoren  
Excavators  
Escavatori  
Excavadores  
Excavateurs



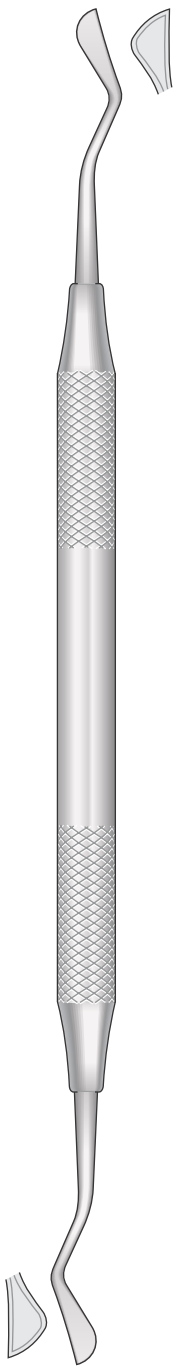
Ø 8 mm  
**Hollow**  
Hohl  
Creux  
Hueco  
Vuoto

NMI-717-100

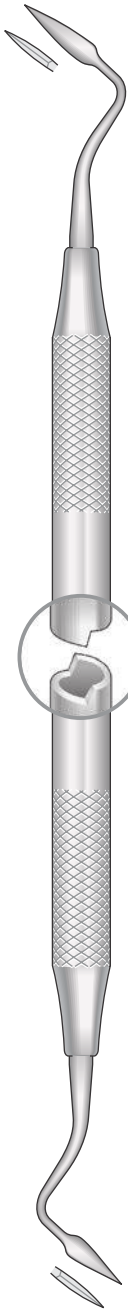
Fig. 2



Parodontalmesser  
Gingivectomy knives  
Bisturi per gengivectomia  
Bisturías para la gingivectomía  
Bistouris pour la gingivectomie



KIRKLAND  
NMI-718-123  
Fig. 15K/16K

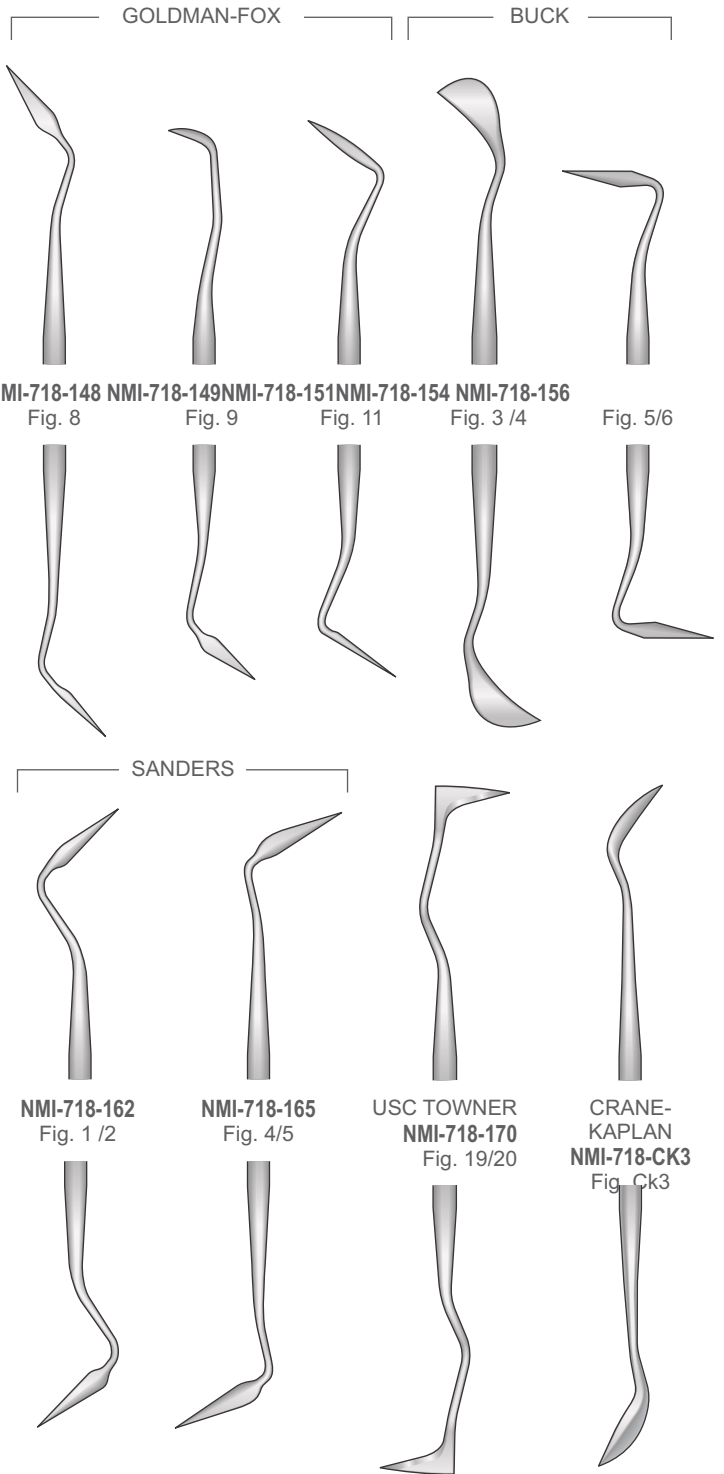


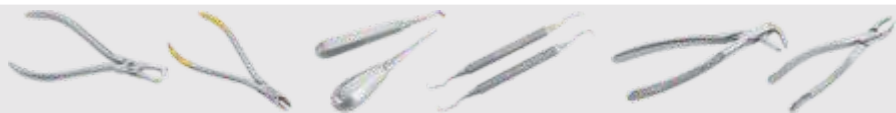
ORBAN  
NMI-718-133  
Fig. 1 / 2

Ø 8 mm  
Hollow  
Hohl  
Creux  
Hueco  
Vuoto



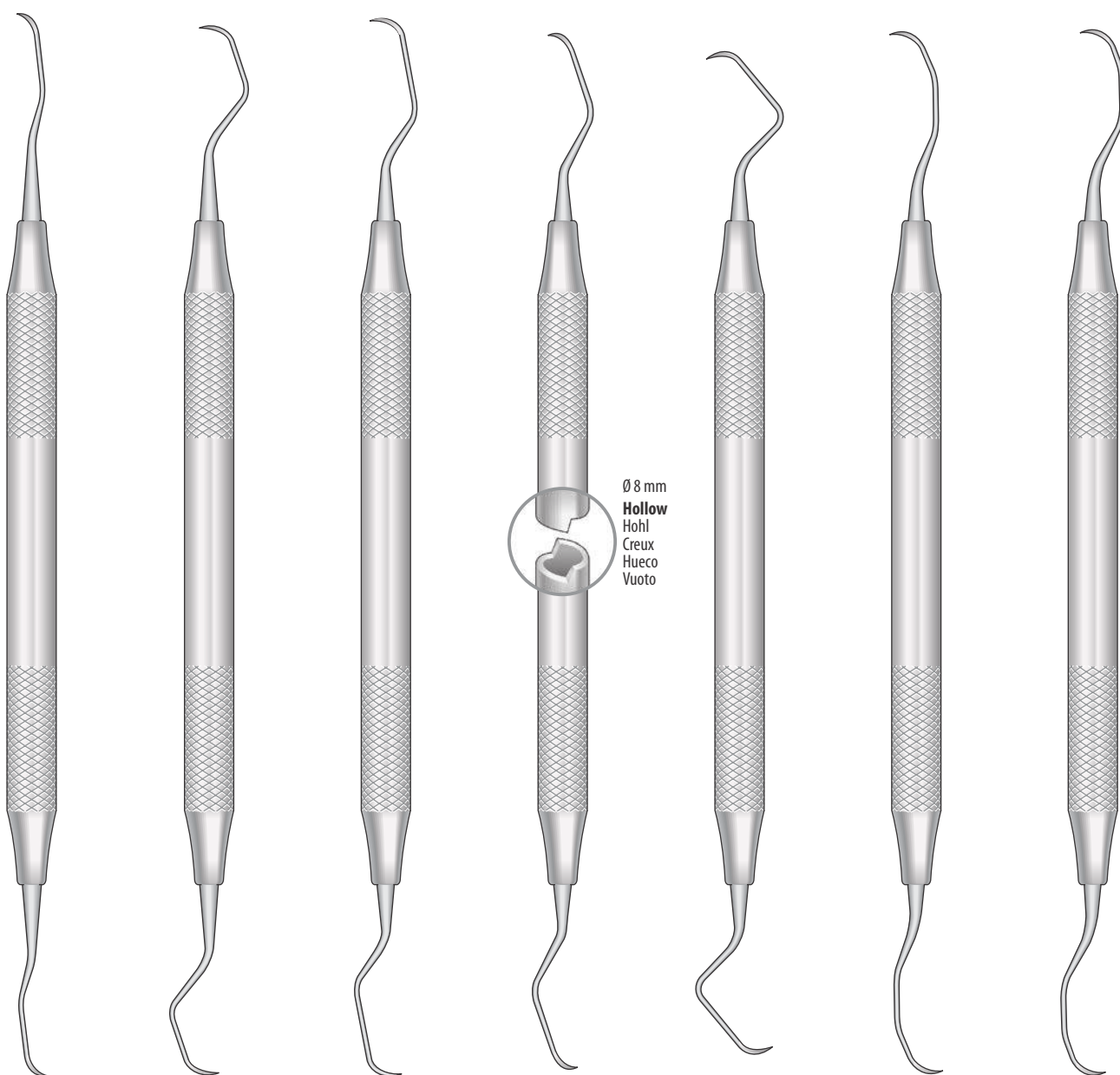
GOLDMAN-FOX  
NMI-718-147  
Fig. 7





Küretten  
Curettes  
Curette  
Curetas  
Curettes

GRACEY



GRACEY  
NMI-718-1/2

GRACEY  
NMI-718-3/4

GRACEY  
NMI-718-5/6

GRACEY  
NMI-718-7/8

GRACEY  
NMI-718-9/10

GRACEY  
NMI-718-11/12

GRACEY  
NMI-718-13/14



Küretten  
Curettes  
Curette  
Curetas  
Curettes

Mesial - Distal



Ø 8 mm  
**Hollow**  
Hohl  
Creux  
Hueco  
Vuoto

GRACEY  
NMI-718-13MD  
Fig. 12/13

DE MARCO  
NMI-718-251  
Fig. 1

DE MARCO  
NMI-718-252  
Fig. 2

COLUMBIA  
NMI-718-2RL  
Fig. 2R/2L

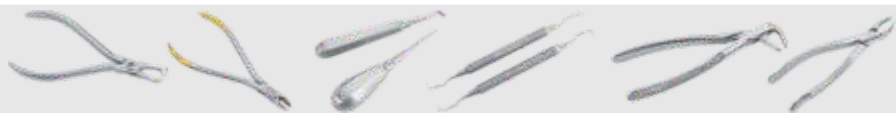
COLUMBIA  
NMI-718-4RL  
Fig. 4R/4L

COLUMBIA  
NMI-718-14  
Fig. 13/14

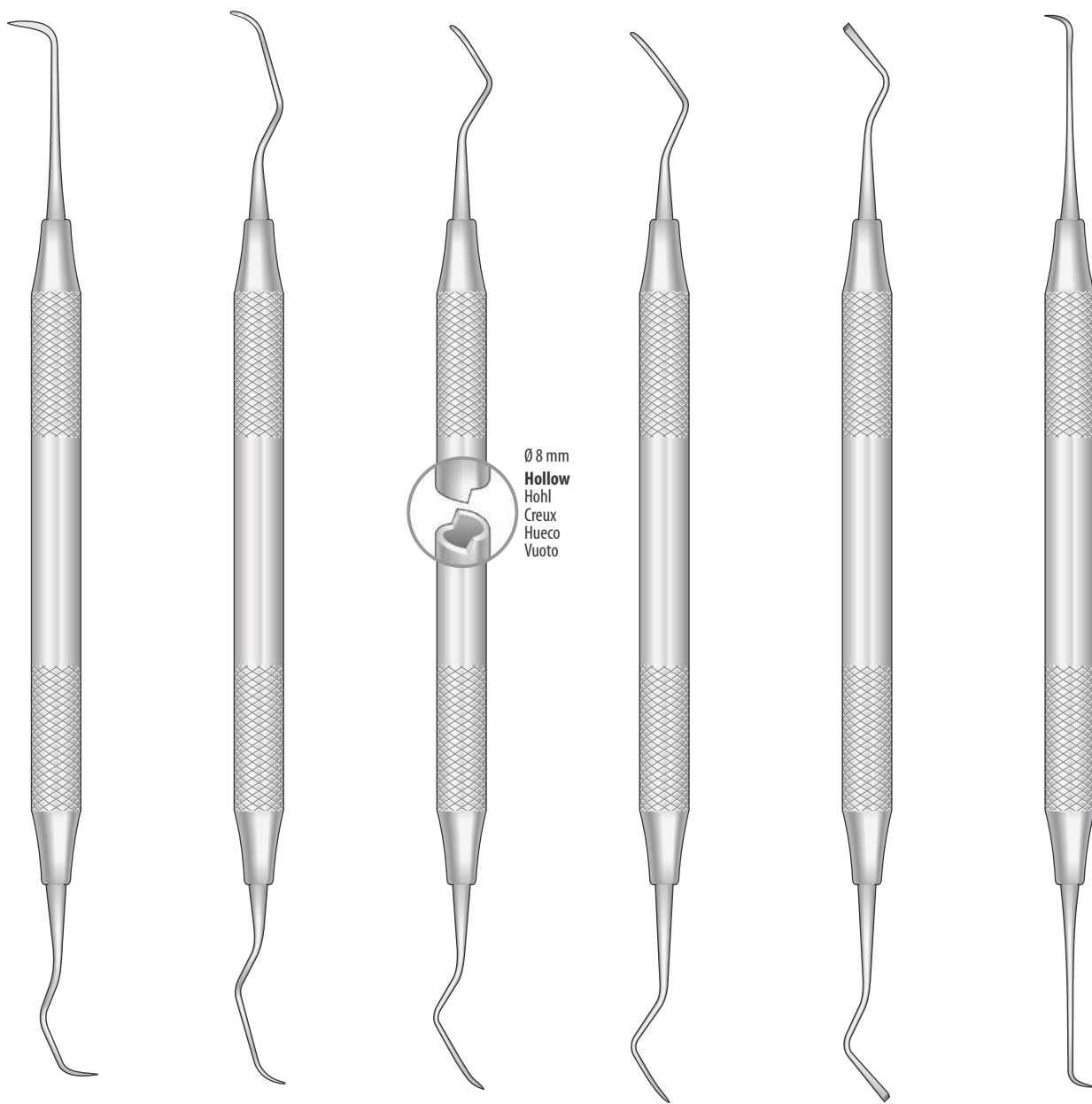
LANGER  
NMI-718-232  
Fig. 1/2

LANGER  
NMI-718-234  
Fig. 3/4

GRACEY  
NMI-718-11MD  
Fig. 11/14



Küretten  
Curettes  
Curette  
Curetas  
Curettes



Ø 8 mm  
**Hollow**  
Hohl  
Creux  
Hueco  
Vuoto

GOLDMAN-FOX  
NMI-718-271  
Fig. 1

GOLDMAN-FOX  
NMI-718-272  
Fig. 2

GOLDMAN-FOX  
NMI-718-273  
Fig. 3

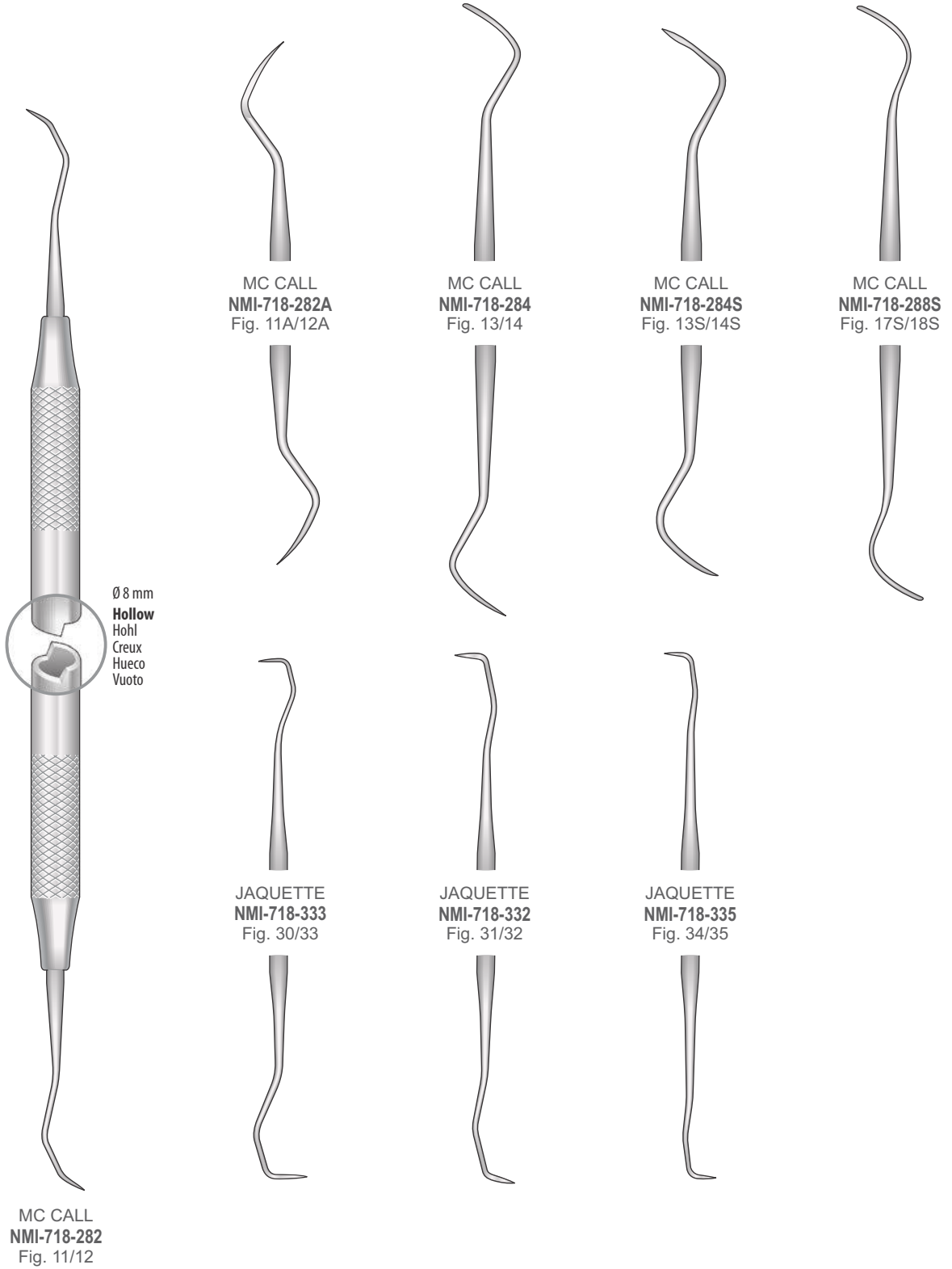
GOLDMAN-FOX  
NMI-718-274  
Fig. 4

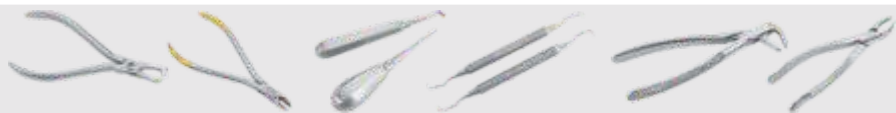
GOLDMAN-FOX  
NMI-718-275  
Fig. 5

GOLDMAN-FOX  
NMI-718-277  
Fig. 21

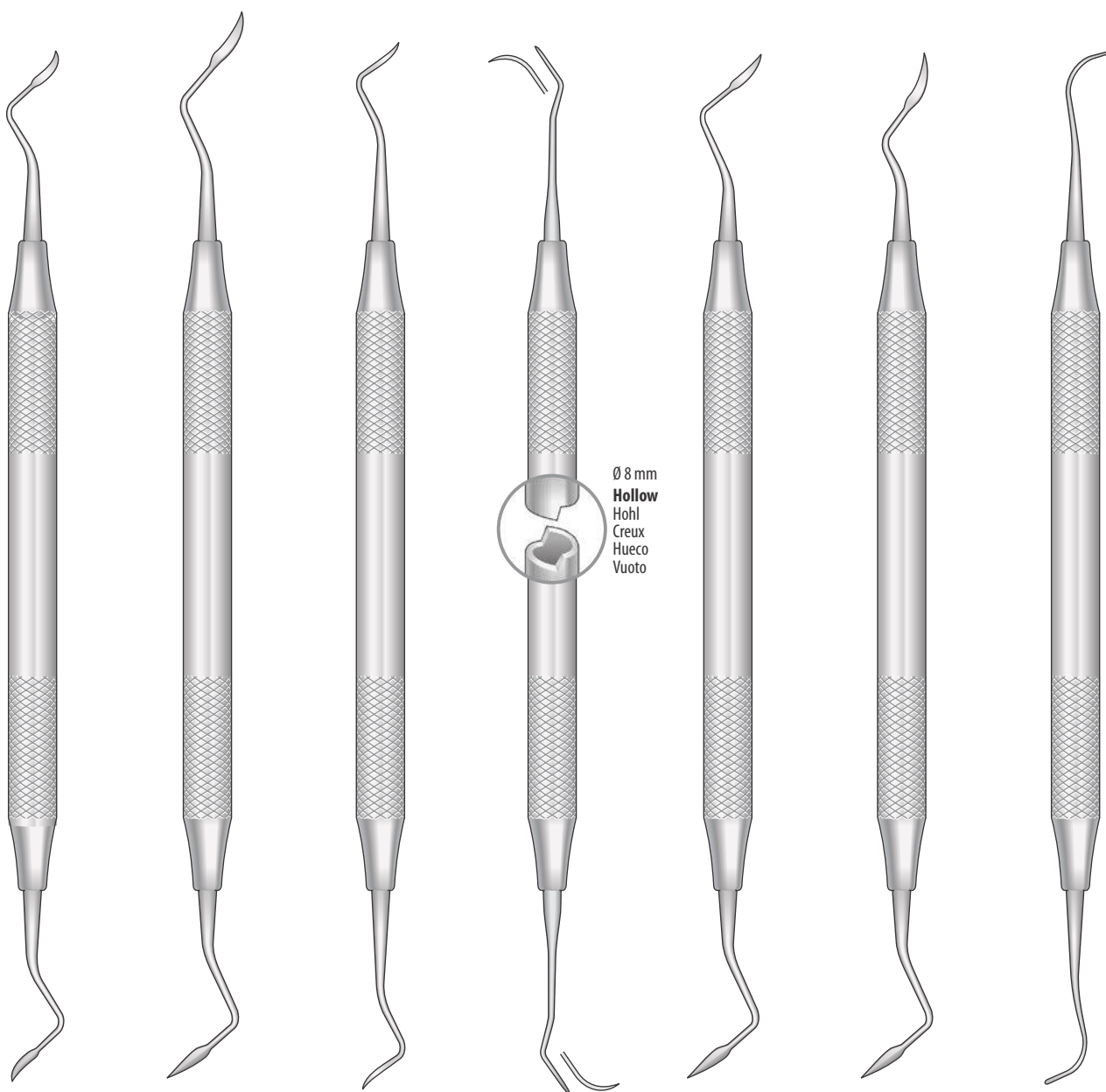


Scaler und Küretten  
Scalers and Curettes  
Scaler e Curette  
Raspadores y Curetas  
Détartreurs et Curettes





Scaler und Küretten  
Scalers and Curettes  
Scaler e Curette  
Raspadores y Curetas  
Détartreurs et Curettes



TAYLOR  
NMI-718-TO3  
Fig. 2/3

NMI-718-204  
Fig. 204

NMI-718-204S  
Fig. 204S

NMI-718-204SD  
Fig. 204SD

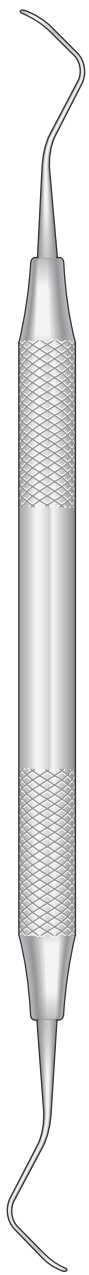
NMI-718-CIO3  
Fig. 2/3

CRANE-  
CAPLAN  
NMI-718-CK6  
Fig. 6

YOUNGER-GOOD  
NMI-718-YGO8  
Fig. 7/8



Scaler und Küretten  
Scalers and Curettes  
Scaler e Curette  
Raspadores y Curetas  
Détartreurs et Curettes



**RULE 23/24**  
**NMI-718-RO4**  
Fig. 3 /4



**I. UNIVERSIT**  
**Y**  
**NMI-718-268**  
Fig. 17/18



**TOWNER-JAQUETTE**  
**NMI-719-111**  
Fig. U15/33

Ø 8 mm  
**Hollow**  
Hohl  
Creux  
Hueco  
Vuoto



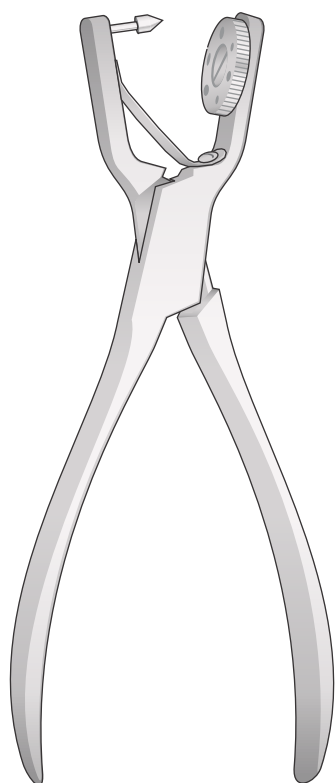
**TOWNER-JAQUETTE**  
**NMI-719-125**  
Fig. H5/33



**TOWNER-JAQUETTE**  
**NMI-719-126**  
Fig. H6/H7

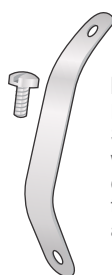


Kofferdam Instrumente  
Rubber-Dam Instruments  
Strumenti per diga  
Instrumentos para dique de goma  
Instruments pour digue de caoutchouc



AINSWORTH  
**NMI-DF-02**  
160 mm

Lochzangen  
Punch Forceps  
Pinze foradiga  
Perforadores  
Pinces à perforer



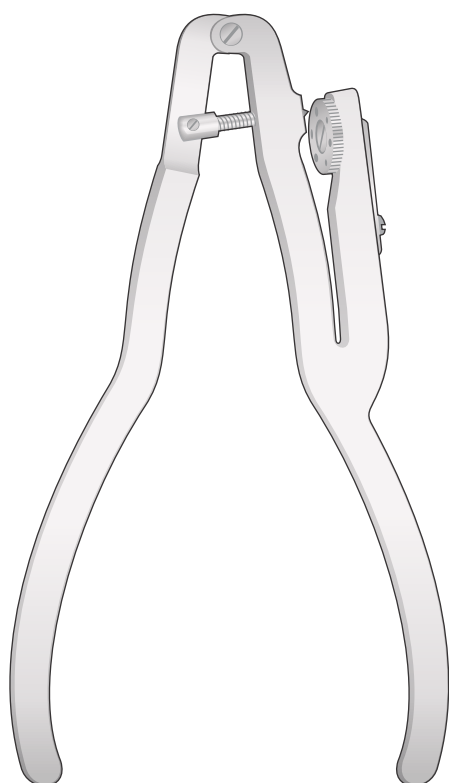
**NMI-DF-02M**  
Feder mit Schraube  
Spring with screw  
Molla con vite  
Muelle con tornillo  
Ressort avec vis



**NMI-DF-02R**  
Lochscheibe  
Punch Disk  
Disco divisore  
Disco agujereado



Disque perforé  
**NMI-DF-02P**  
Stift, mit Schraube  
Pin, with screw  
Perno con vite  
Punzòn con perno



IVORY  
**NMI-DF-00**

Lochzangen  
Punch Forceps  
Pinze foradiga  
Perforadores  
Pinces à perforer



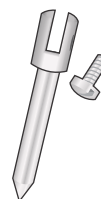
**NMI-DF-00M**  
Spiralfeder  
Spiral Spring  
Molla a spirale  
Muelle espiral  
Ressort en



spirale  
**NMI-DF-00L + NMI-DF-00V**  
Feder mit Schraube  
Spring with screw  
Molla con vite  
Muelle con tornillo



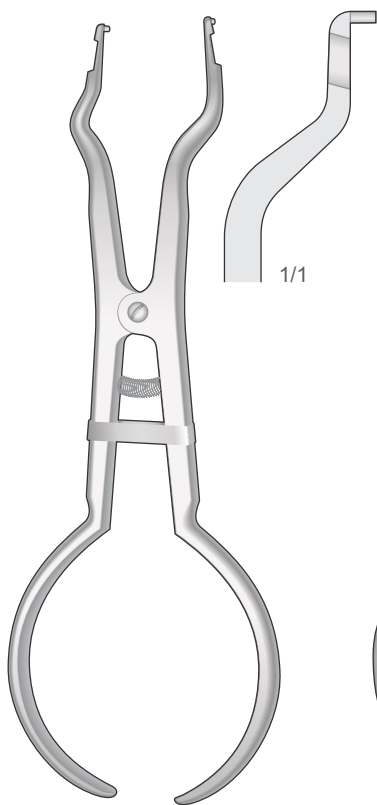
**NMI-DF-00R**  
Lochscheibe  
Punch Disk  
Disco divisore  
Disco agujereado



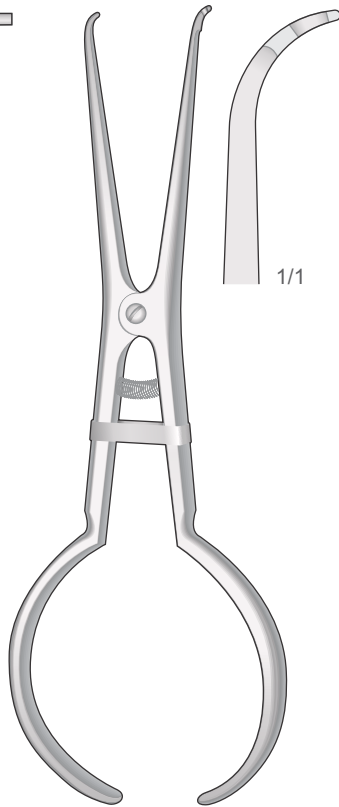
Disque perforé  
**NMI-DF-00P + NMI-DF-00N**  
Stift, mit Schraube  
Pin, with screw  
Perno con vite  
Punzòn con perno



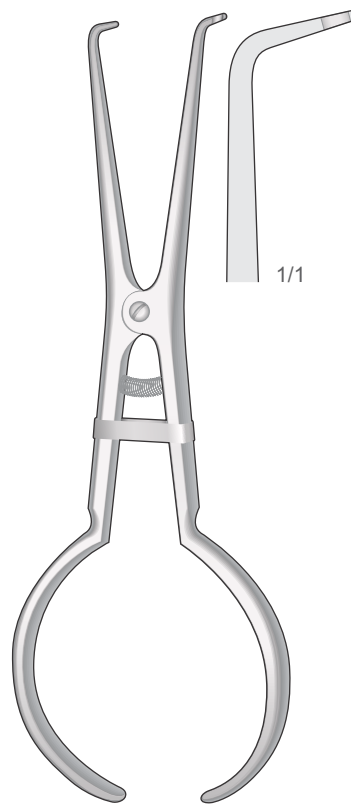
Kofferdam-Klammerzangen  
Rubber-Dam Clamp Forceps  
Pinze per uncini  
Pinzas para grapas dique de goma  
Pincas porte-crampons



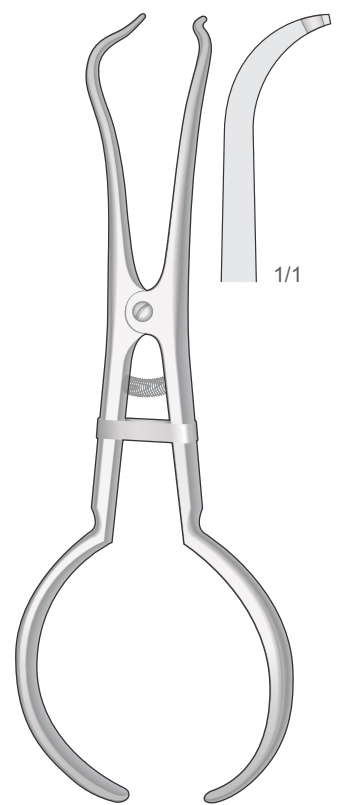
**BREWER**  
**NMI-DF-10**  
170 mm



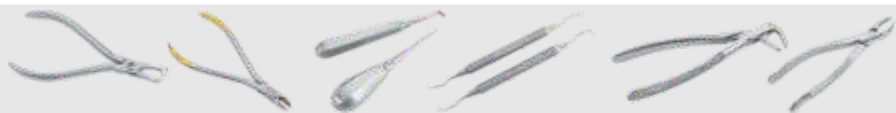
**PALMER**  
**NMI-DF-15**  
170 mm



**STOKE**  
**NMI-DF-16**  
170 mm



**NMI-DF-18**  
170 mm



Matrizenspanner und Matrizenbänder  
Matrix Retainers and Matrix Bands  
Portamatrici e matrici  
Portamatrices y bandas matrices  
Porte-matrices et bagues matrices

Molaren, 12 Stück  
Molars, 12 pieces  
Molari, 12 pezzi  
Molares, 12 piezas  
Molaires, 12  
Pièces

Premolaren, 12 Stück  
Premolars, 12 pieces  
Premolari, 12 pezzi  
Premolares, 12 piezas  
Prémolaires, 12  
Pièces



**NMI-DF-40/1**  
Fig.1



**NMI-DF-41/4**  
Fig.4



**NMI-DF-40/2**  
Fig.2



**NMI-DF-41/5**  
Fig.5

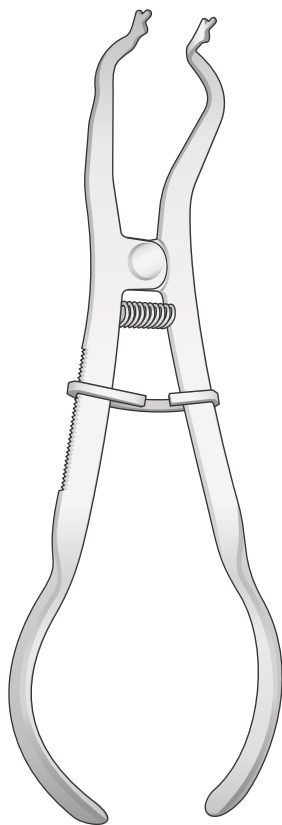


**NMI-DF-40/3**  
Fig.3

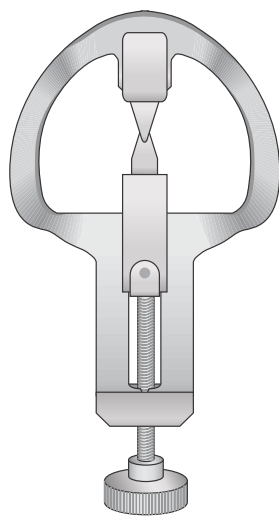


**NMI-DF-41/6**  
Fig.6

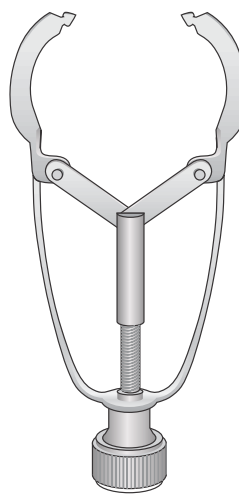
Kofferdam-Klammerzangen  
Rubber-Dam Clamp Forceps  
Pinze per uncini  
Pinzas para grapas dique de goma  
Pincers porte-crampons



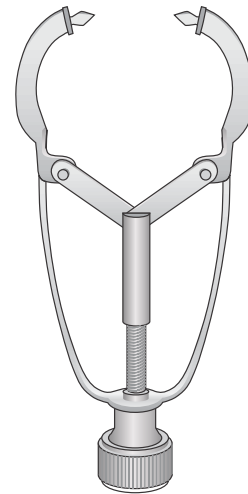
**IVORY**  
**NMI-DF-12**  
170 mm



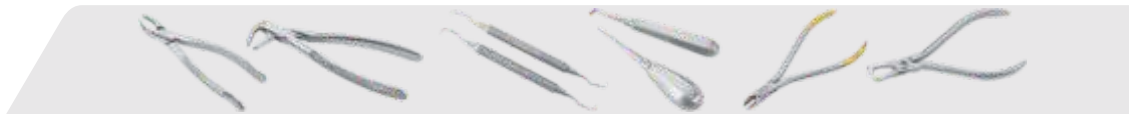
**IVORY**  
**NMI-DF-43**  
Fig. 14



**IVORY**  
**NMI-DF-40**  
Fig. 1



**IVORY**  
**NMI-DF-41**  
Fig. 12



Kofferdam Instrumente  
Rubber-Dam Instruments  
Strumenti per diga  
Instrumentos para dique de goma  
Instruments pour digue de caoutchouc

Kofferdam-Klammern  
Rubber-Dam Clamps  
Uncini per diga  
Clamps para diques  
Crampons pour digue



IVORY  
NMI-DF-126  
# 26



IVORY  
NMI-DF-127  
# 27



IVORY  
NMI-DF-128  
# 28



IVORY  
NMI-DF-129  
# 29



IVORY  
NMI-DF-130  
# 30



IVORY  
NMI-DF-131  
# 31

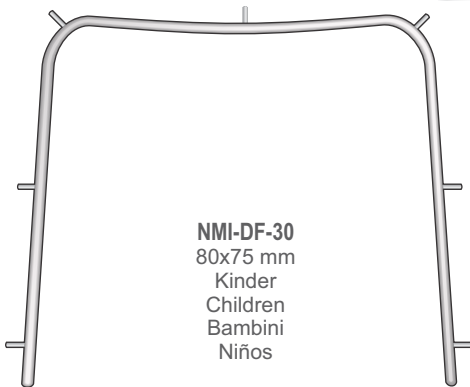


IVORY  
NMI-DF-151  
# 51

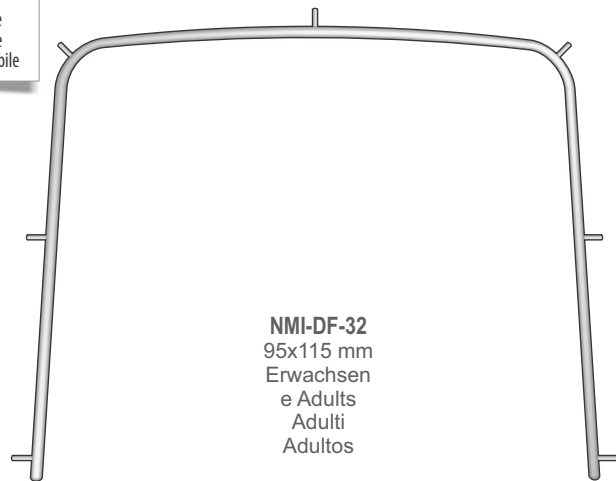


IVORY  
NMI-DF-160  
# 60

Kofferdam-Rahmen  
Rubber-Dam Frames  
Telaio per diga  
Cuadro para diques  
Cadre à digue



NMI-DF-30  
80x75 mm  
Kinder  
Children  
Bambini  
Niños



NMI-DF-32  
95x115 mm  
Erwachsen  
e Adults  
Adulti  
Adultos



Matrizenspanner und Matrizenbänder  
Matrix Retainers and Matrix Bands  
Portamatrici e matrici  
Portamatrices y bandas matrices  
Porte-matrices et bagues matrices

Molaren, 12 Stück  
Molars, 12 pieces  
Molari, 12 pezzi  
Molares, 12 piezas  
Molaires, 12  
Pièces



**NMI-DF-03/7**  
#7



**NMI-DF-03/8**  
#8



**NMI-DF-03/9**  
#9



**NMI-DF-03/10**  
#10

Premolaren, 12 Stück  
Premolars, 12 pieces  
Premolari, 12 pezzi  
Premolares, 12 piezas  
Prémolaires, 12  
Pièces



**NMI-DF-03/11**  
#11



**NMI-DF-03/12**  
#12



**NMI-DF-03/13**  
#13

TOFFLEMIRE  
Universal



**NMI-DF-03/1**  
#1



**NMI-DF-03/2**  
#2



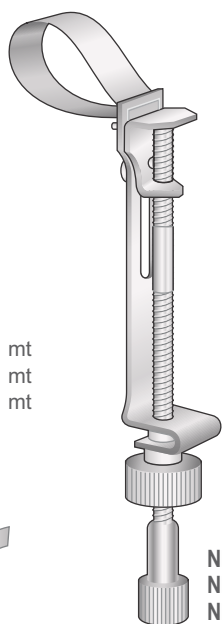
**NMI-DF-03/3**  
#3



**NMI-DF-01/5** 5 mm x 1 mt  
**NMI-DF-01/6** 6 mm x 1 mt  
**NMI-DF-01/7** 7 mm x 1 mt



**NMI-DF-05/5** 5 mm x 5 mt  
**NMI-DF-05/6** 6 mm x 5 mt  
**NMI-DF-05/7** 7 mm x 5 mt



IVORY  
**NMI-DF-06/NMI-DF-09**  
#8

**NMI-DF-06** 5 mm  
**NMI-DF-08** 6 mm  
**NMI-DF-09** 7 mm

Paar - Pair  
Coppia -  
Par Paire

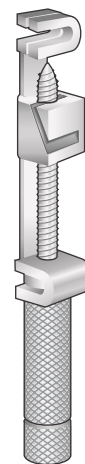


#1  
Rechts  
Right  
Destra  
Derech  
a Droite



#2  
Links  
Left  
Sinistra  
Izquierd  
a  
Gauche

NYSTRÖM  
**NMI-DF-04**  
#1 + #2



TOFFLEMIRE  
**NMI-DF-07**  
Universal

# DENTAL Instruments

Extracting Forceps

Root Elevators

Scalpel Blades and Handles

Surgical Scissors

Tissue and Dressing Forceps

Needle Holders

Hemostatic Forceps | Towel Clamps

Retractors | Mouth Gags

Implantology

Periosteal | Curettes | Rongeurs

Dental Restoration | Periodontology

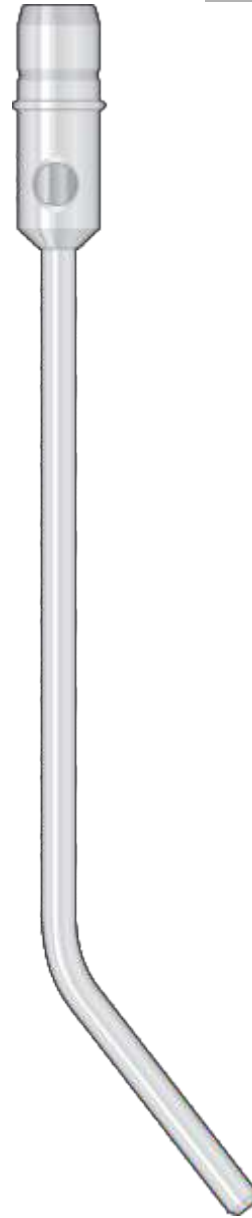
**Suction Tube**

Orthodontics

Crown Instruments | Laboratory

Instrument Maintenance | Sterilization

12



304-310

Suction Tubes

Saugkanülen

Canules d'aspiration

Cánulas de aspiración

Cannule per aspirazione

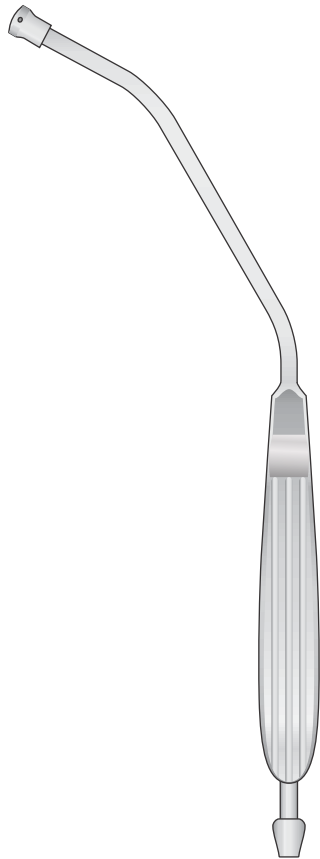


Saugkanülen  
Suction Tubes  
Cannule per  
aspirazione Cánulas de  
aspiración Canules  
d'aspiration

**Stainless Steel**  
Rostfreier Stahl  
Acier inoxydable  
Acero inoxidable  
Acciaio inossidabile



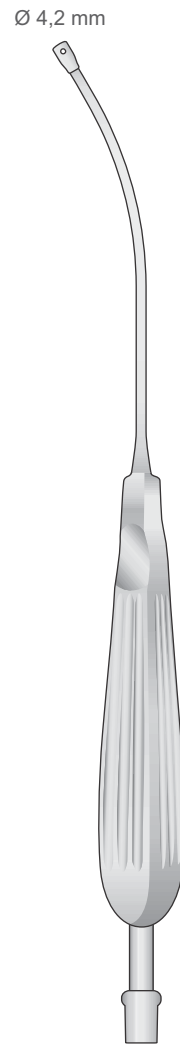
**YANKAUER  
NMI-GF-12**  
310 mm



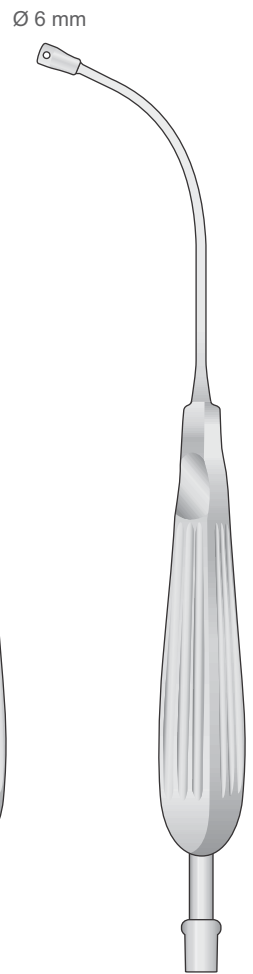
**BABY-YANKAUER  
NMI-GF-10**  
200 mm



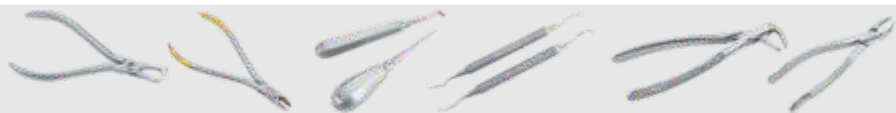
**ANDREWS-  
PYNCHON  
NMI-GF-06**  
250 mm



**ANDREWS-  
PYNCHON  
NMI-GF-07**  
250 mm

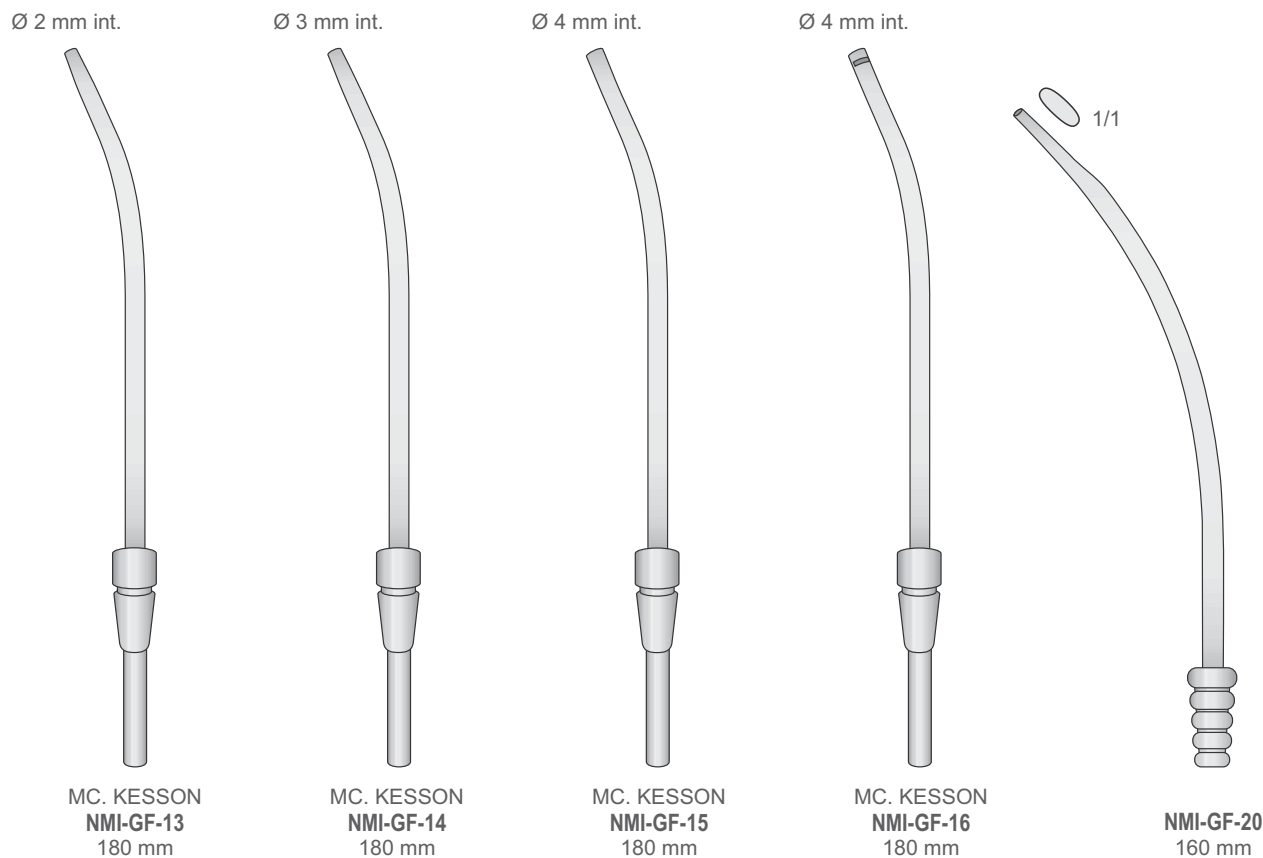
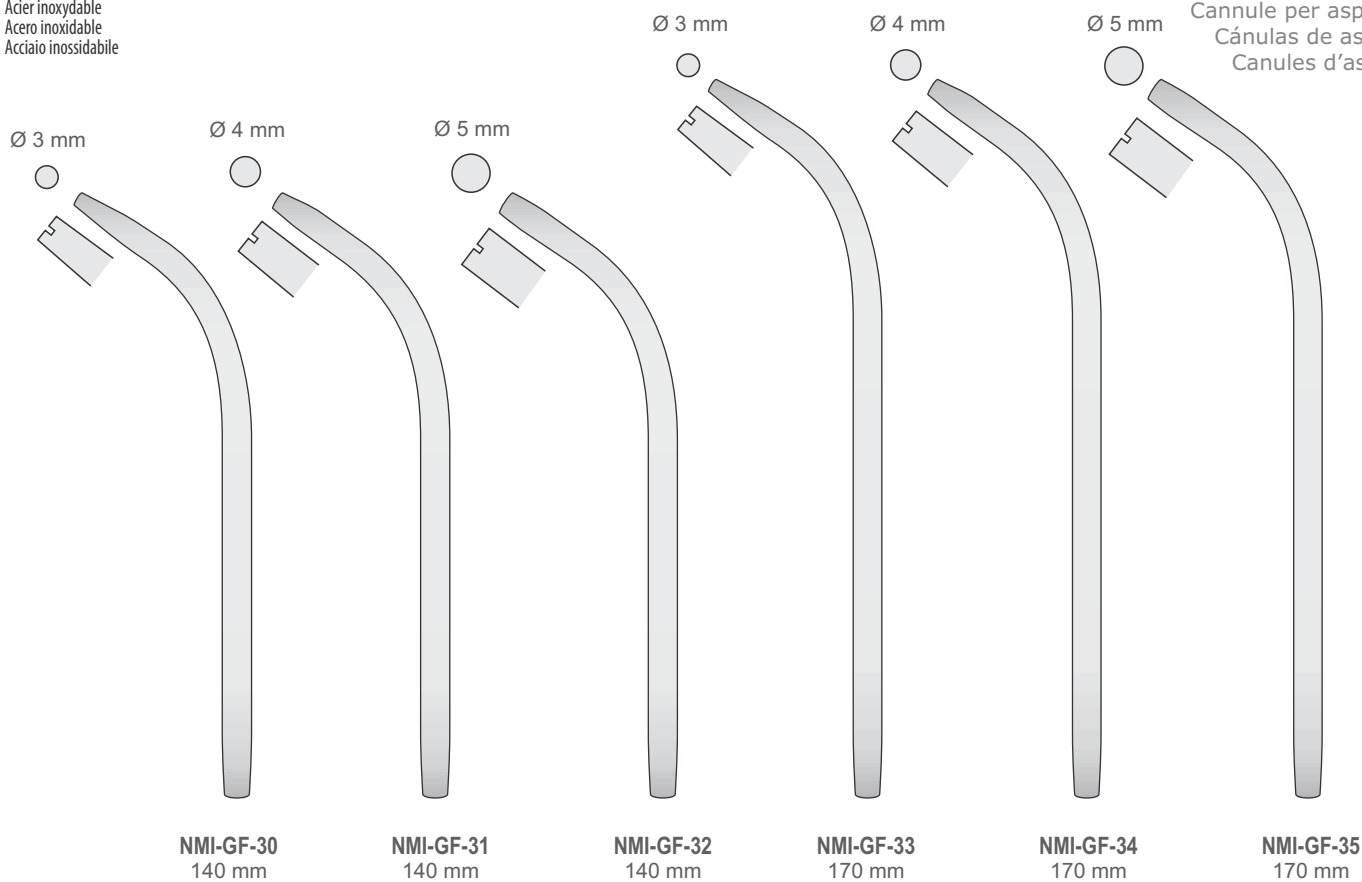


**ANDREWS-  
PYNCHON  
NMI-GF-54**  
230 mm



**Stainless Steel**  
Rostfreier Stahl  
Acier inoxydable  
Acero inoxidable  
Acciaio inossidabile

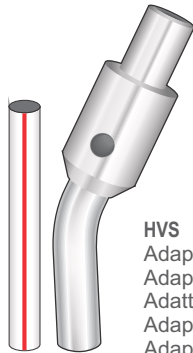
Saugkanülen  
Suction Tubes  
Cannule per aspirazione  
Cánulas de aspiración  
Canules d'aspiration





Saugkanülen  
Suction Tubes  
Cannule per  
aspirazione Cánulas de  
aspiración Canules  
d'aspiration

**Stainless Steel**  
Rostfreier Stahl  
Acier inoxydable  
Acero inoxidable  
Acciaio inossidabile



**NMI-TS-40**  
Connection piece for suction  
75 mm - 100% Stainless Steel

**HVS**  
Adaptor  
Adapter  
Adattatore  
Adaptador  
Adaptateur



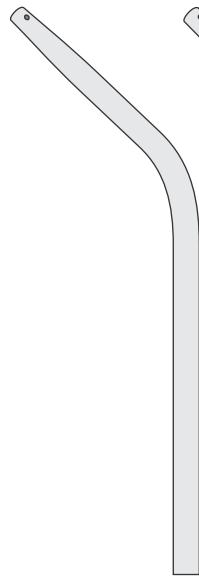
**COUPLAN D**  
**NMI-GF-01**  
150 mm

Ø 1 mm

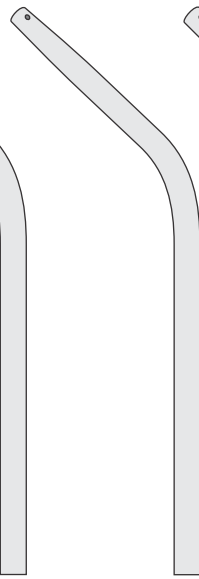
Ø 1,5 mm

Ø 2,5 mm

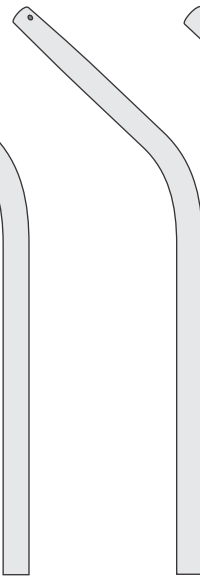
Ø 3,5 mm int.



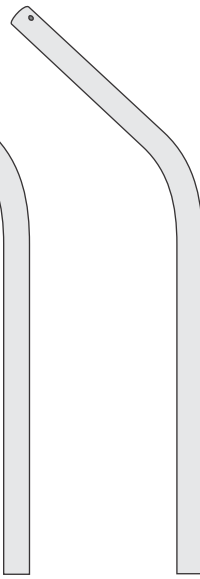
**NMI-GF-05**  
95 mm



**NMI-GF-04**  
95 mm



**NMI-GF-03**  
95 mm



**NMI-GF-02**  
95 mm

**COMPLETE SET**  
**NMI-GF-11**  
(NMI-GF-01 + NMI-GF-02 + NMI-GF-03 +  
NMI-GF-04 + NMI-GF-05)  
Griff + 4 Kanülen  
Handle + 4 tubes  
Manico + 4 cannule  
Mango + 4 cánulas  
Manche + 4 canules



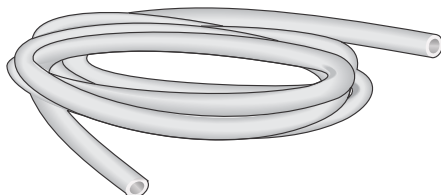
**NMI-GF-271**  
56 mm

Adaptor  
Adapter  
Adattatore  
Adaptador  
Adaptateur

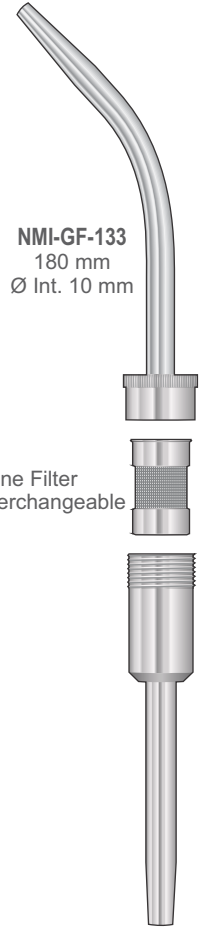
Ø Ext. 6,0 mm  
Ø Int. 4,5 mm

**Autoclavable Tubing**  
Schlauch - Silikon  
Flexible Tube - Silicone  
Raccordo in silicone per  
cannule Tubo flexible de silicona  
Tuyau - Silicone

**NMI-TS-50**  
2 m

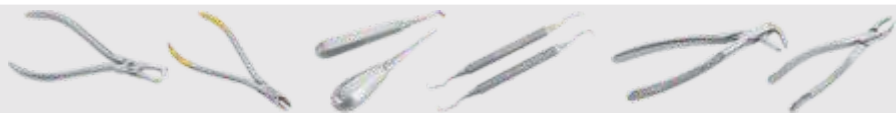


**NMI-GF-901**  
B1 Byrd  
Self-Cleaning



**NMI-GF-133**  
180 mm  
Ø Int. 10 mm

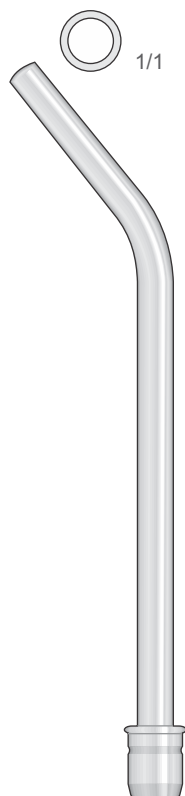
Bone Filter  
interchangeable



Saugkanülen  
Suction Tubes  
Cannule per aspirazione  
Cánulas de aspiración  
Canules d'aspiration

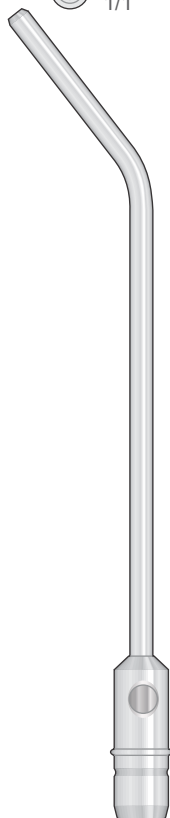
**Stainless Steel**  
Rostfreier Stahl  
Acier inoxydable  
Acero inoxidable  
Acciaio inossidabile

Ø Est. 8 mm  
Ø Int. 6 mm  
1/1

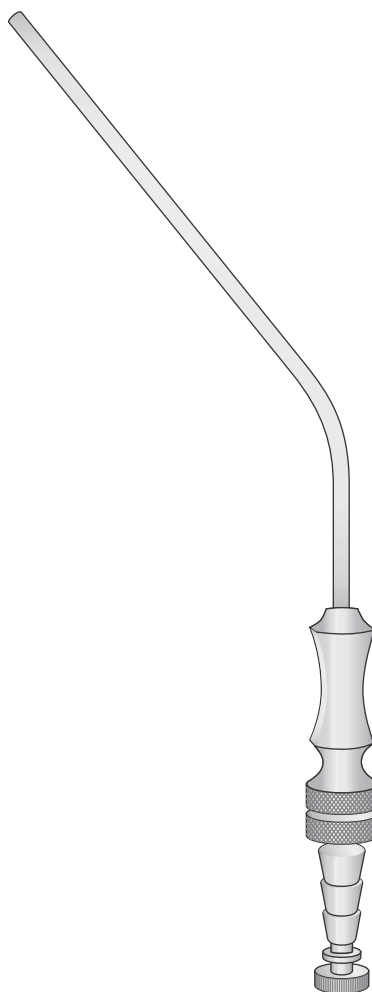


PELTON-CRANE  
NMI-GF-184  
140 mm

Ø Est. 5 mm  
Ø Int. 2,5 mm  
1/1



PELTON-CRANE  
NMI-GF-180  
160 mm



FRAZIER  
NMI-GF-240/NMI-GF-244  
180 mm

NMI-GF-240	Ch. 6	2.0 mm
NMI-GF-241	Ch. 7	2.3 mm
NMI-GF-241B	Ch. 8	2.5 mm
NMI-GF-242	Ch. 9	3.0 mm
NMI-GF-242B	Ch. 10	3.3 mm
NMI-GF-243	Ch. 12	4.0 mm
NMI-GF-244	Ch. 15	5.0 mm



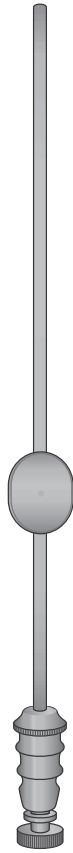
Saugkanülen  
Suction Tubes  
Cannule per  
aspirazione Cánulas de  
aspiración Canules  
d'aspiration

**Stainless Steel**  
Rostfreier Stahl  
Acier inoxydable  
Acero inoxidable  
Acciaio inossidabile



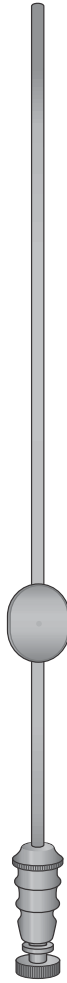
Flexible  
Flexibel  
Flexible  
Flexible  
Flessibile  
Ø 3 mm

WERTHEIMER  
NMI-GF-69  
160 mm



**Chromium Black**  
Schwarz-Chrom  
Chrome noir  
Cromado negro  
Cromato nero

FRAZIER  
NMI-GF-70  
160 mm

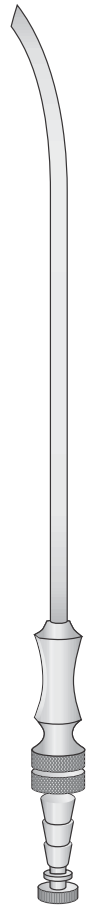


Flexible  
Flexibel  
Flexible  
Flexible  
Flessibile  
Ø 3 mm

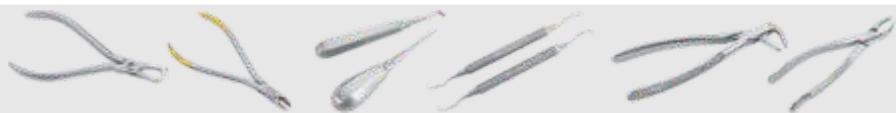
FRAZIER  
NMI-GF-61  
200 mm



WERTHEIMER  
NMI-GF-60  
200 mm



ADSON  
NMI-GF-41 ch. 12 Ø 4 mm  
NMI-GF-42 ch. 15 Ø 5 mm  
210 mm



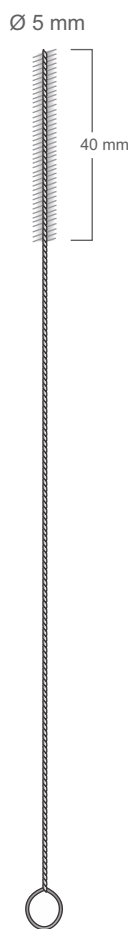
Kanülenreinigungs-Bürsten  
Cleaning brush for Tubes  
Scovolini per pulizia cannule  
Cepillo para limpiar cánulas  
Brosse de nettoyage pour canules



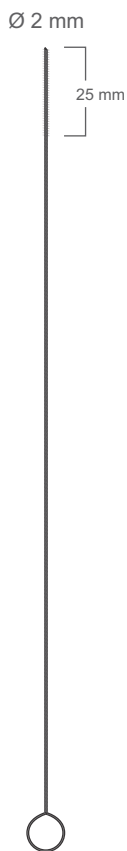
Bürsten  
Brush  
Spazzola  
Cepillo  
Brosse

Autoklav  
Autoclavable  
Autoclavabil  
e Autoclave

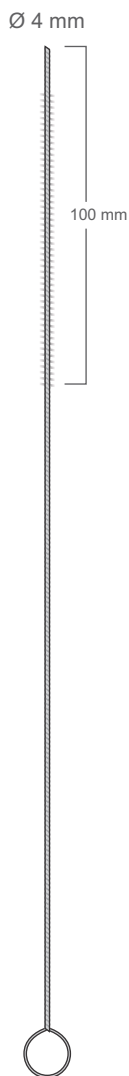
**NMI-GF-200**  
4 x 11 cm



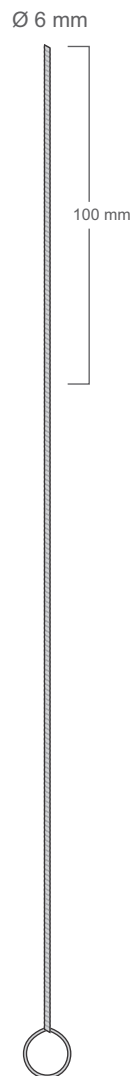
**NMI-GF-40**  
235 mm



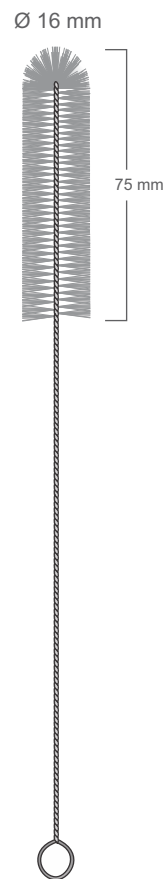
**NMI-GF-182**  
215 mm



**NMI-GF-183**  
300 mm



**NMI-GF-185**  
300 mm



**NMI-GF-188**  
220 mm

# DENTAL Instruments

Extracting Forceps

Root Elevators

Scalpel Blades and Handles

Surgical Scissors

Tissue and Dressing Forceps

Needle Holders

Hemostatic Forceps | Towel Clamps

Retractors | Mouth Gags

Implantology

Periosteal | Curettes | Rongeurs

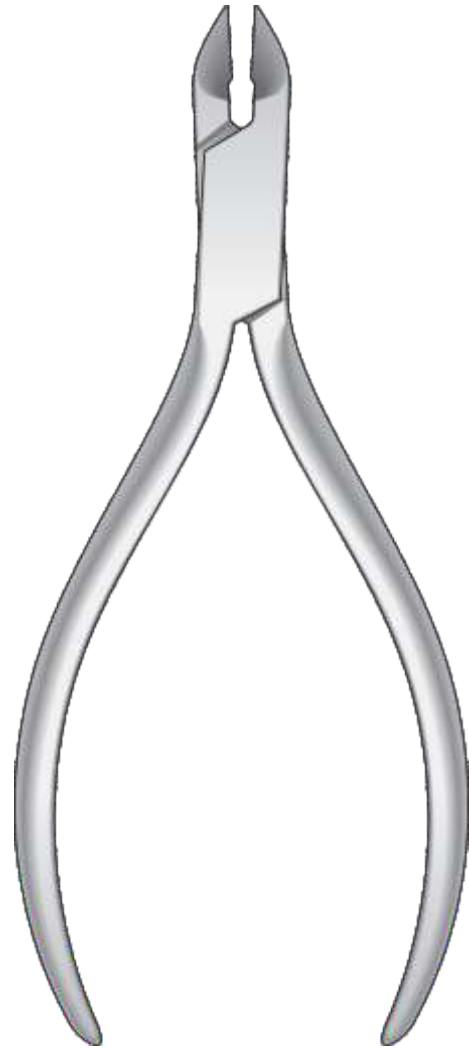
Dental Restoration | Periodontology

Suction Tube

Orthodontics

Crown Instruments | Laboratory

Instrument Maintenance | Sterilization



311-320

**Orthodontics**

Kieferorthopädi

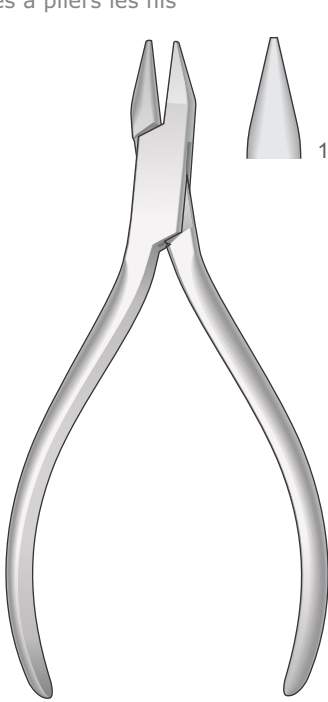
e Orthodontie

Ortodoncia

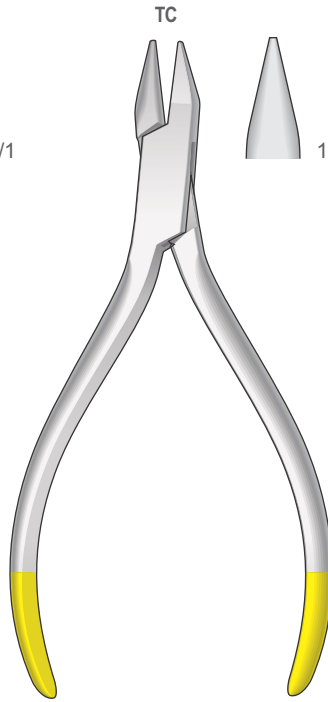
Ortodonzia



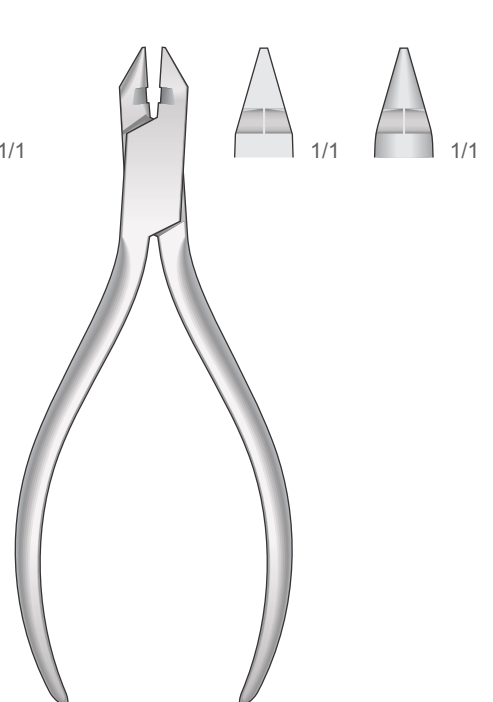
Drahtbiegeezangen  
Wire Bending Pliers  
Pinze per piegare fili  
Alicates para doblar alambres  
Pincès à pliers les fils



**NMI-DP-118**  
130 mm

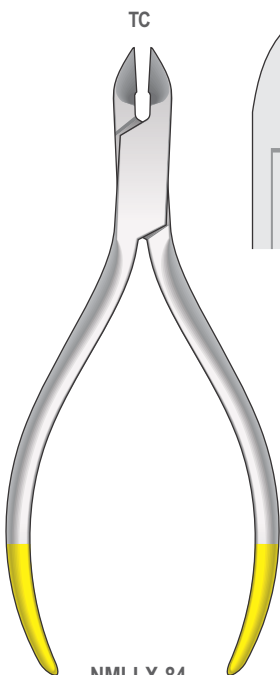


**NMI-DP-119**  
130 mm

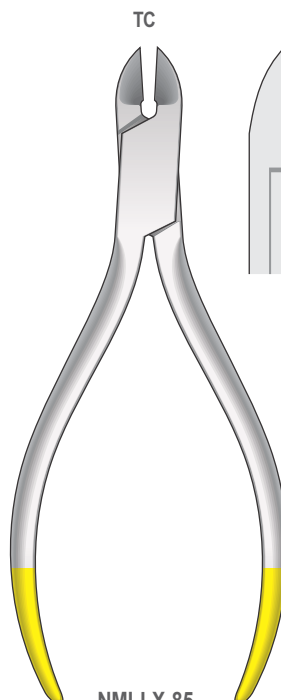


**NMI-DP-121**  
130 mm

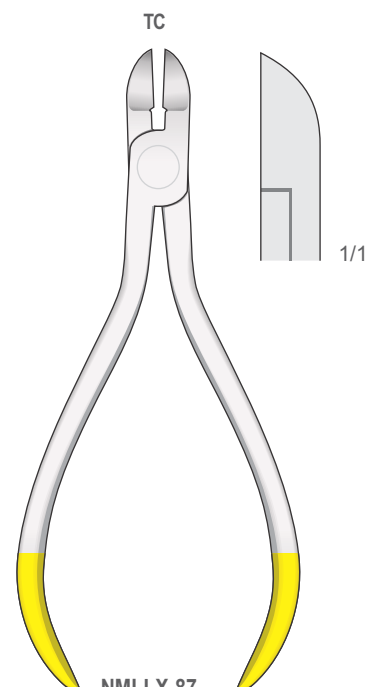
**Tungsten-Carbide Inserts**  
Mit Hartmetalleinsätzen  
Plaquettes en carbure de tungstène  
Plaquetas de carburo de tungsteno  
Inserti in carburo di tungsteno



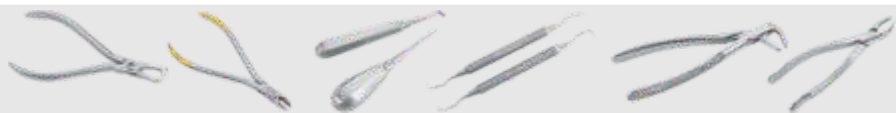
**NMI-LX-84**  
125 mm



**NMI-LX-85**  
130 mm

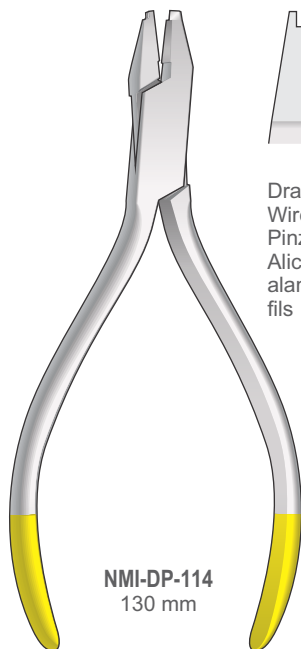


**NMI-LX-87**  
125 mm

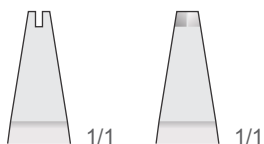


Drahtbiegezaugen  
Wire Bending Pliers  
Pinze per piegare fili  
Alicates para doblar alambres  
Pinces à pliers les fils

TC

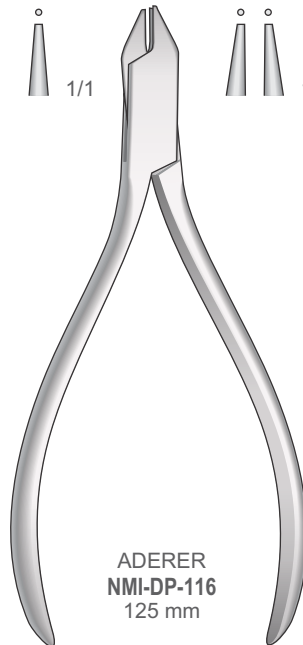


**NMI-DP-114**  
130 mm

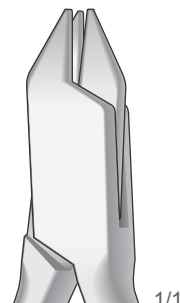


Drahtbiegezaugen  
Wire Bending Pliers  
Pinze per piegare fili  
Alicates para doblar alambres  
Pinces à pliers les fils

Mod. Medium  
Mod. Medio

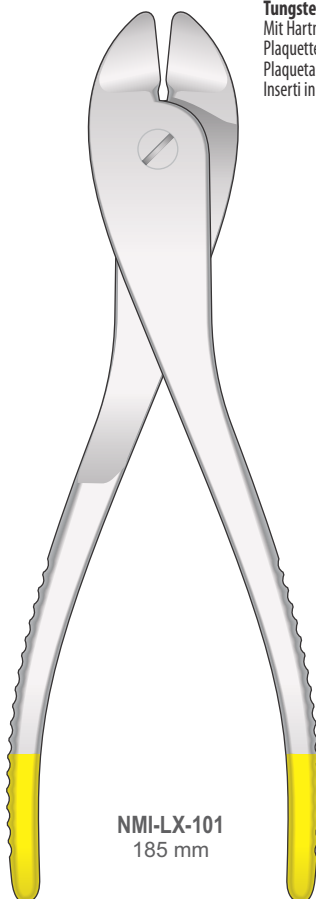


**ADERER**  
**NMI-DP-116**  
125 mm



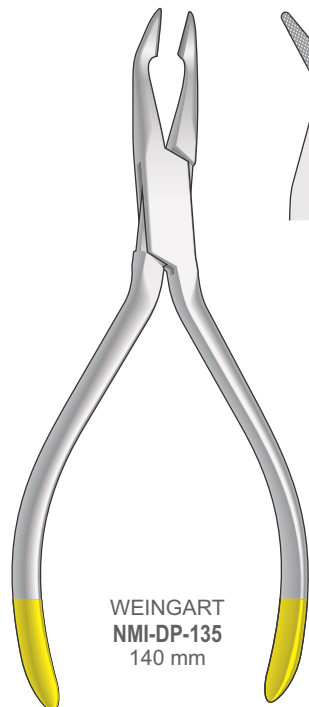
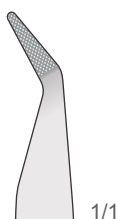
TC

**Tungsten-Carbide Inserts**  
Mit Hartmetalleinsätzen  
Plaquettes en carbure de tungstène  
Plaquetas de carburo de tungsteno  
Inserti in carburo di tungsteno

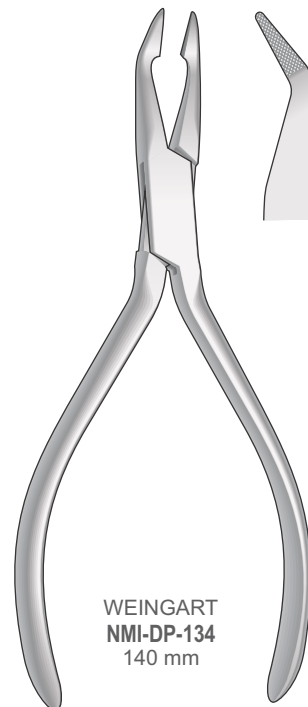
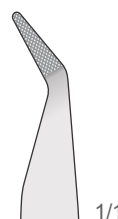


**NMI-LX-101**  
185 mm

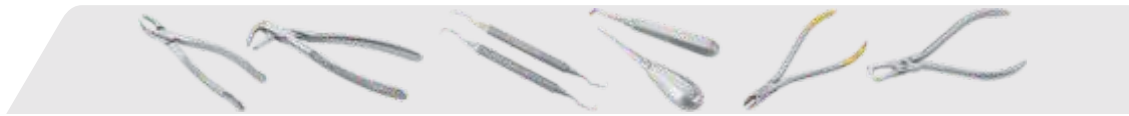
TC



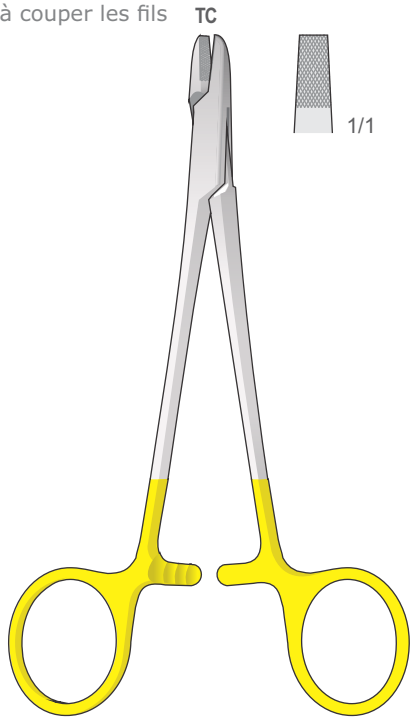
**WEINGART**  
**NMI-DP-135**  
140 mm



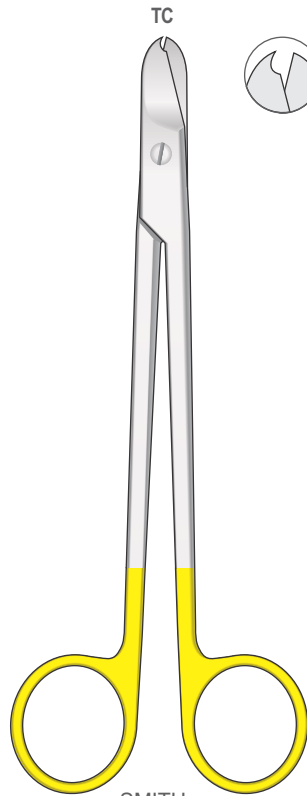
**WEINGART**  
**NMI-DP-134**  
140 mm



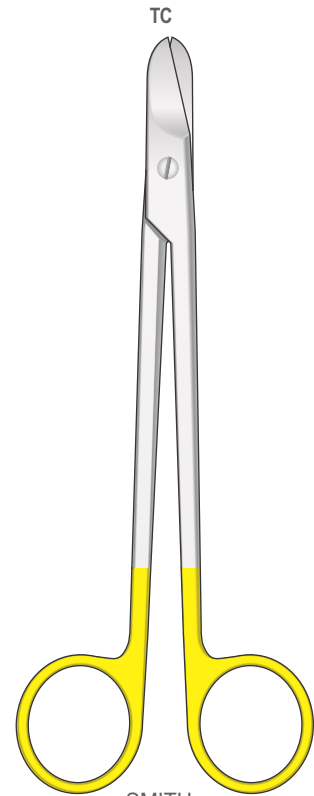
Drahtschneidezangen  
Wire cutting pliers  
Tronchesi per fili metallici  
Alicates para cortar alambre  
Pinces à couper les fils



**NMI-PH-58**  
150 mm

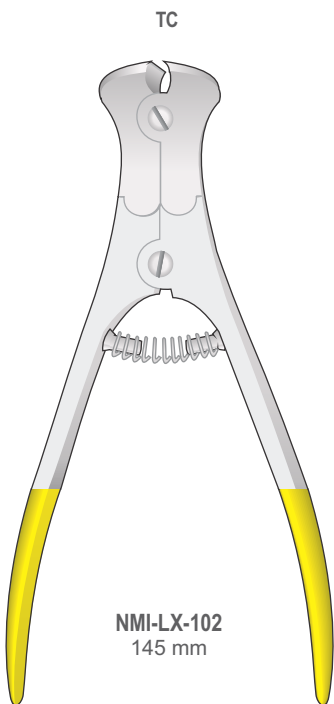


**SMITH**  
**NMI-FG-161**  
160 mm

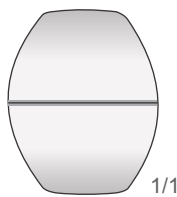


**SMITH**  
**NMI-FG-160**  
160 mm

**Tungsten-Carbide Inserts**  
Mit Hartmetalleinsätzen  
Plaquettes en carbure de tungstène  
Plaquetas de carburo de tungsteno  
Inserti in carburo di tungsteno



**NMI-LX-102**  
145 mm

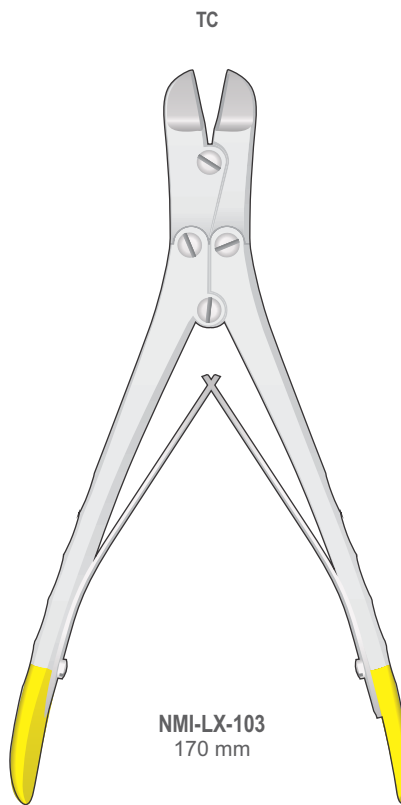


○ Max Ø 2.0 mm (.078")

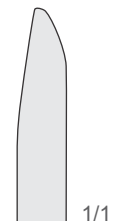
Für weichen Draht  
For soft Wire  
Per filo leggero  
Para alambre  
blando

○ Max Ø 1.5 mm (.059")

Für harten Draht  
For hard Wire  
Per filo duro  
Para alambre  
duro



**NMI-LX-103**  
170 mm

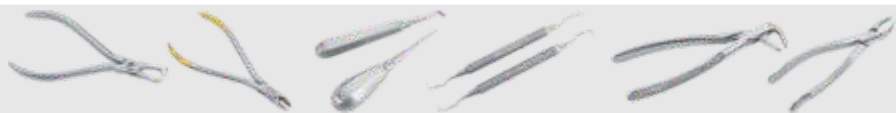


○ Max Ø 2.0 mm (.078")

Für weichen Draht  
For soft Wire  
Per filo leggero  
Para alambre  
blando

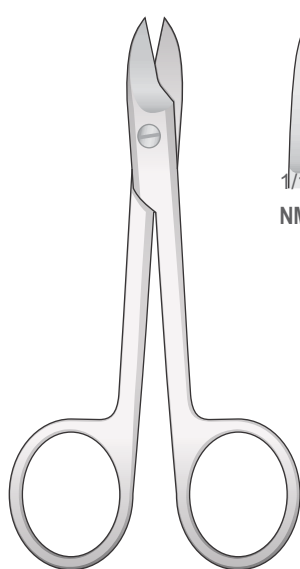
○ Max Ø 1.5 mm (.059")

Für harten Draht  
For hard Wire  
Per filo duro  
Para alambre  
duro

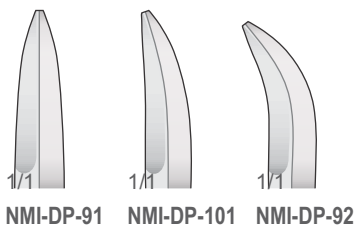


Scheren  
Scissors  
Forbici  
Tijeras  
Ciseaux

Scheren für dünne Stahl-und Edelmetallbleche - Scissors for thin steel and precious metal sheets  
Forbici per lamine sottili di acciaio e metalli preziosi - Tijeras para láminas delgadas de acero y metales preciosos  
Ciseaux pour couper les feuilles de métaux

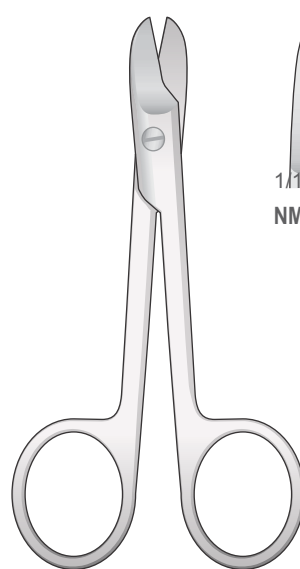


**BEEBE**  
**NMI-DP-91/NMI-DP-92**  
110 mm

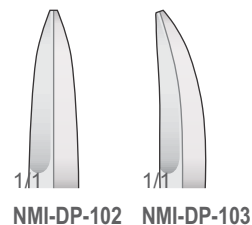


**NMI-DP-91**   **NMI-DP-101**   **NMI-DP-92**

Spitz  
Sharp  
Acute  
Agud  
a  
Pointu



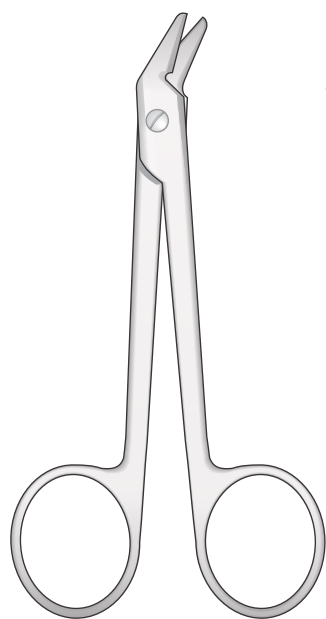
**BEEBE**  
**NMI-DP-102/NMI-DP-103**  
110 mm



**NMI-DP-102**   **NMI-DP-103**

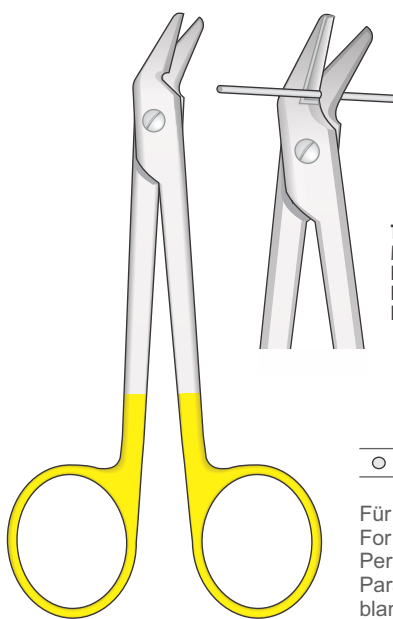
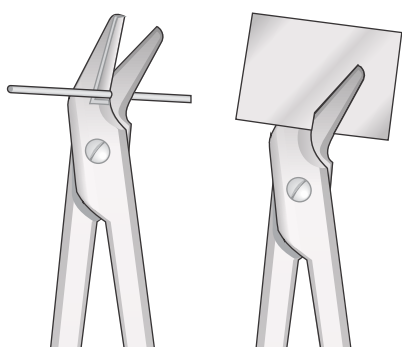
Stumpf  
Blunt  
Smuss  
e Roma  
Mousse

Scheren für dünne Stahl-und Edelmetallbleche - Scissors for thin steel and precious metal sheets  
Forbici per lamine sottili di acciaio e metalli preziosi - Tijeras para láminas delgadas de acero y metales preciosos  
Ciseaux pour couper les feuilles de métaux



**NMI-DP-90**  
120 mm

Draht-und Blechschere  
gezahnt Wire cutting scissor  
serrated Forbice universale  
dentellata Tijeras para cortar  
hilo  
de acero dentadas  
Coupe-fils dentelé

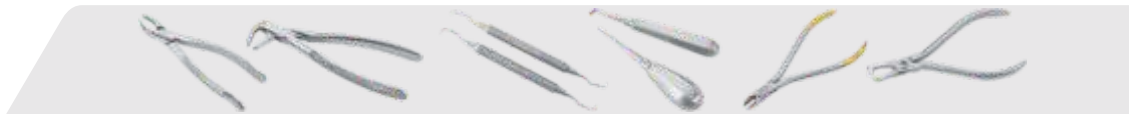


**NMI-DP-120**  
120 mm

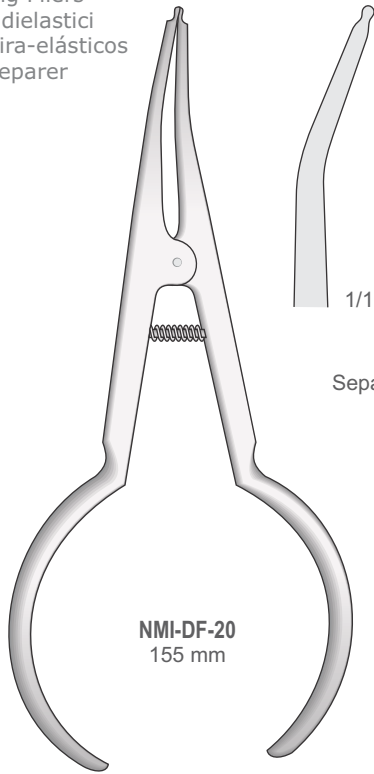
**Tungsten-Carbide Inserts**  
Mit Hartmetalleinsätzen  
Plaquettes en carbure de tungstène  
Plaquetas de carburo de tungsteno  
Inserti in carburo di tungsteno

○ Max Ø 1.2 mm (.048")

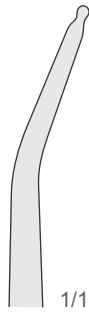
Für weichen Draht  
For soft Wire  
Per filo leggero  
Para alambre  
blando Pour fil léger



Separierzangen  
Separating Pliers  
Pinze tendielastici  
Pinza estira-elásticos  
Pince à separer



**NMI-DF-20**  
155 mm



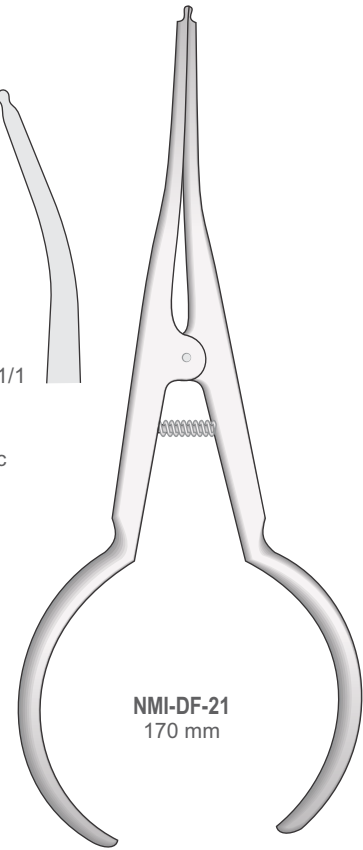
1/1



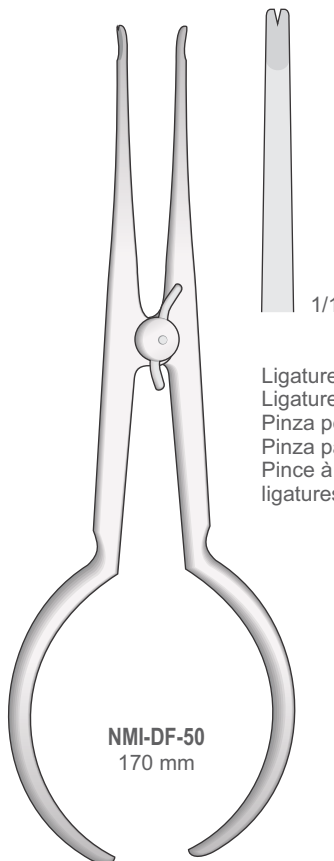
Separierzange, zum Einbringen von Gummi-Separierligaturen Separating forceps for inserting elastic separators  
Pinze per legature per separatori elastici  
Pinza para ligaduras estira-elásticos



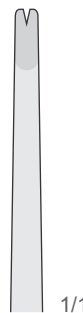
1/1



**NMI-DF-21**  
170 mm



**NMI-DF-50**  
170 mm



1/1

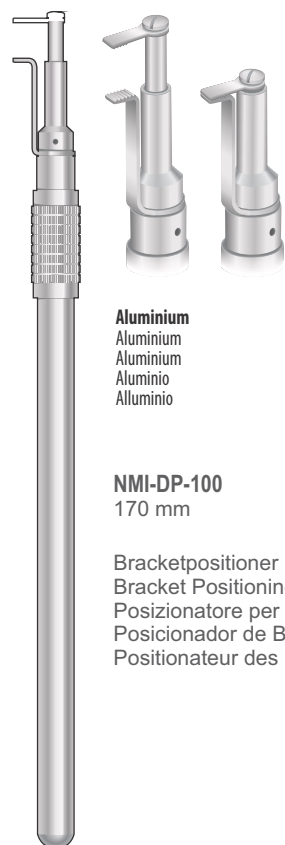
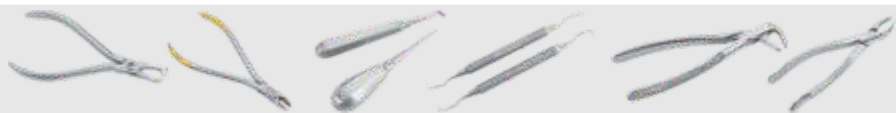
Ligaturenspannzange  
Ligature Tying Plier  
Pinza per legature  
Pinza para ligaduras  
Pince à serrer les ligatures



**NMI-DP-150**  
160 mm

5.0  
4.0  
0

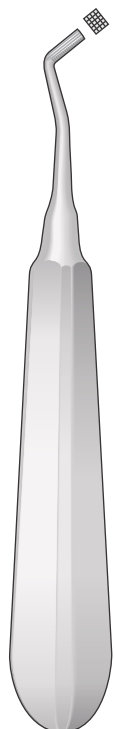
Bracketset Pinzette  
Bonding Bracket Forceps  
Pinzette per brackets  
Pinza fina para ligar brackets  
Fine pince à lier des boîtiers



**Aluminium**  
Aluminium  
Aluminium  
Aluminio  
Alluminio

**NMI-DP-100**  
170 mm

Bracketpositioner  
Bracket Positioning Gauge  
Posizionatore per attacchi  
Posicionador de Brackets  
Positionateur des



Gezahnt  
Serrated  
Dentellat  
o  
Dentado  
Dentelé

**MERSHON**  
**NMI-DP-50**  
140 mm

Brackets  
Verbandschieber  
Band Pusher  
Spingibande  
Empujador de

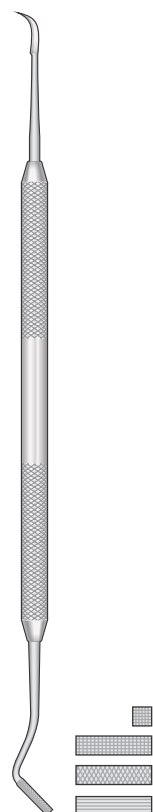
Utility Instrumente  
Utility Instruments  
Strumenti di utilità  
Instrumentos para utilidad  
Instruments pour utility

Ligaturen Instrumente  
Ligating Instruments  
Strumenti per legature  
Instrumentos para  
ligaduras Instruments pour  
ligatures

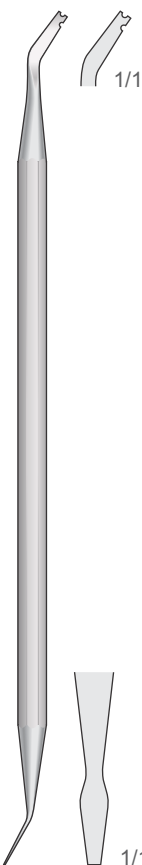
**NMI-DP-100**  
170 mm



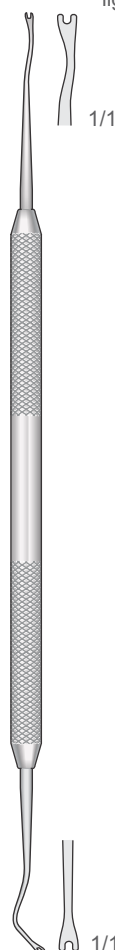
**SHURE**  
**NMI-DP-124**  
175 mm



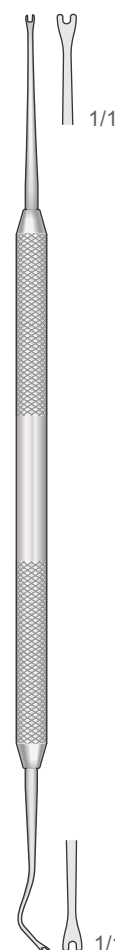
**NMI-DP-54**  
175 mm



**NMI-DP-125**  
155 mm



**NMI-PF-1**  
170 mm



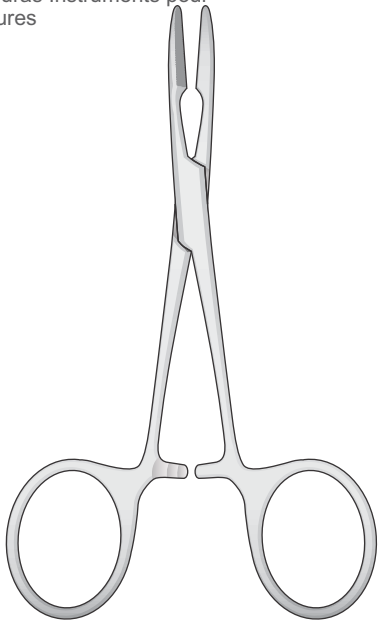
**NMI-PF-2**  
170 mm



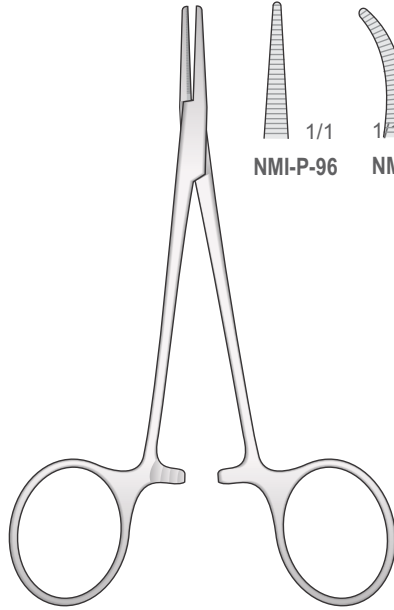
**NMI-PF-3**  
160 mm



Ligature Instruments  
Ligating Instruments  
Strumenti per legature  
Instrumentos para  
ligaduras Instruments pour  
ligatures



PEAN-  
MURPHY  
NMI-BF-22  
130 mm

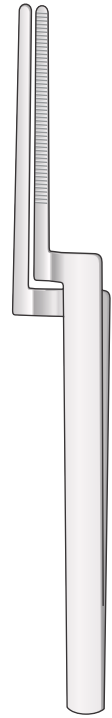


1/1  
NMI-P-96  
1/4  
NMI-P-97

HALSTED-MOSQUITO  
NMI-P-96/NMI-P-97  
120 mm



NMI-COLLEGE  
150 mm



MILLE  
R  
DR-78  
145  
mm

Bracketset Pinzette - Forceps for positioning brackets  
Pinzette per riposizionare gli attacchi diretti  
(posizionamento dei bracket)  
Pinza para colocar brackets - Précelle pour positionner les  
brackets

Bracket Gauge  
Stainless Steel



NMI-DP-132  
130 mm



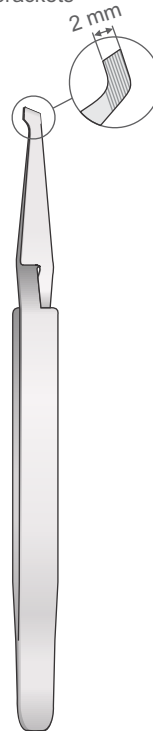
NMI-DP-133  
130 mm



NMI-DP-52  
130 mm



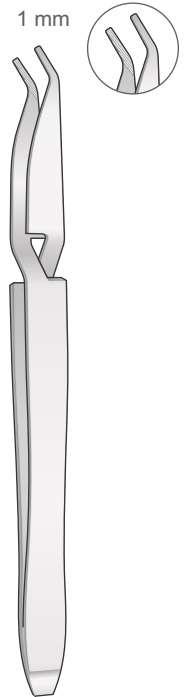
NMI-DP-126  
110 mm



NMI-DP-127  
125 mm



NMI-DP-128  
145 mm

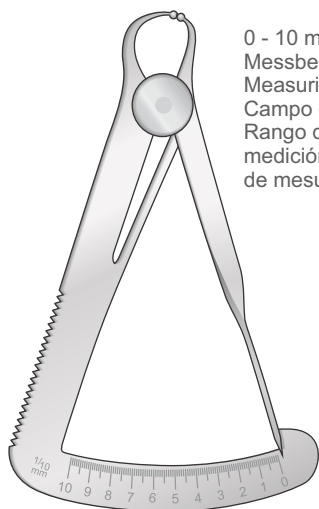


NMI-DP-129  
130 mm



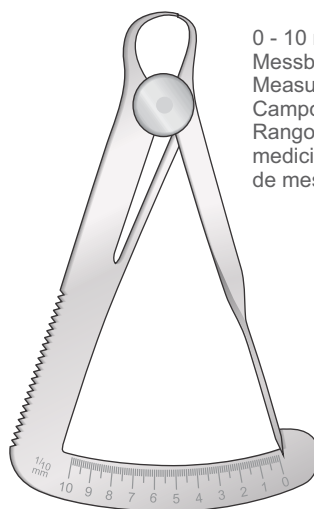
Messinstrumente  
Measuring Instruments  
Strumenti per misura  
Instrumentos de medición  
Instruments à mesurer

Dental-Schieblehre für Praxis und Labor  
Gauge Caliper for practice and laboratory  
Calibri dentali per studio e laboratorio  
Calibrador dental para práctica y el  
laboratorio Gauge calibreur pour practice et  
laboratoire



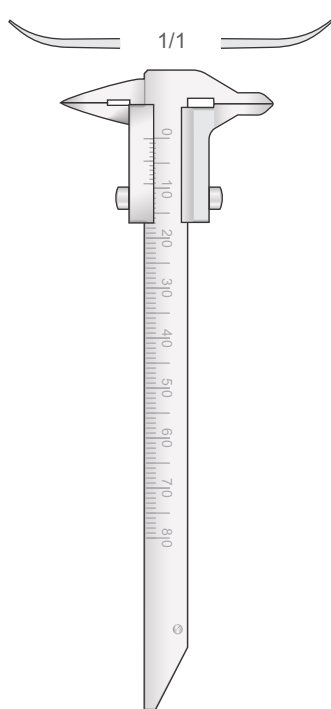
0 - 10 mm  
Messbereich  
Measuring range  
Campo di misura  
Rango de  
medición Champ  
de mesure

**IWANSON**  
**NMI-DP-721**  
100 mm

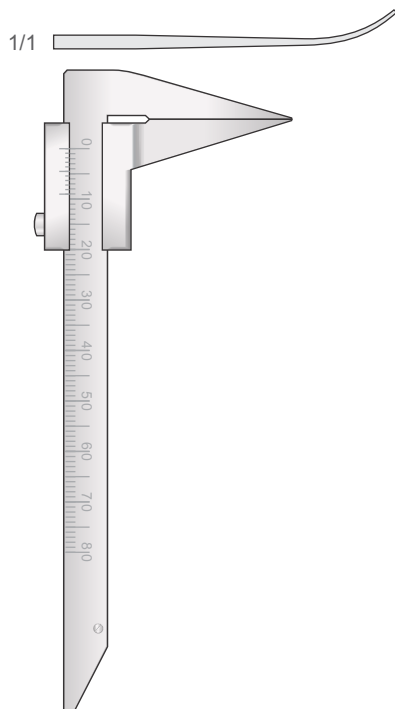


0 - 10 mm  
Messbereich  
Measuring range  
Campo di misura  
Rango de  
medición Champ  
de mesure

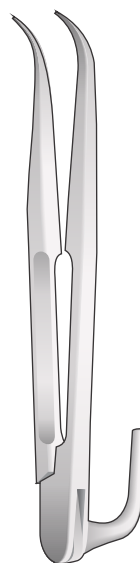
**IWANSON**  
**NMI-DP-720**  
100 mm



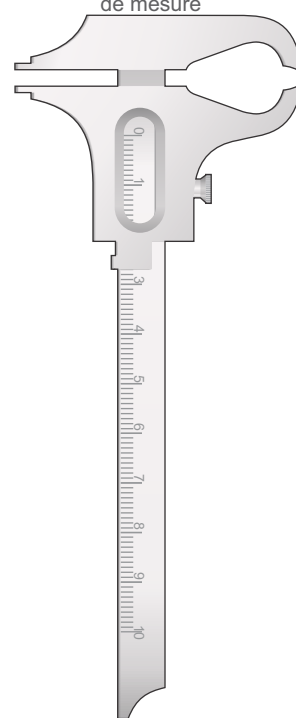
**NMI-DP-723**  
80 mm



**NMI-DP-724**  
80 mm

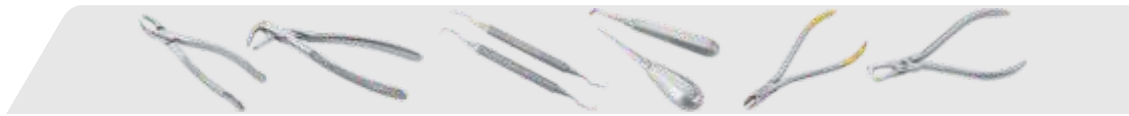


**ZIELINSKY**  
**NMI-DP-725**  
110 mm

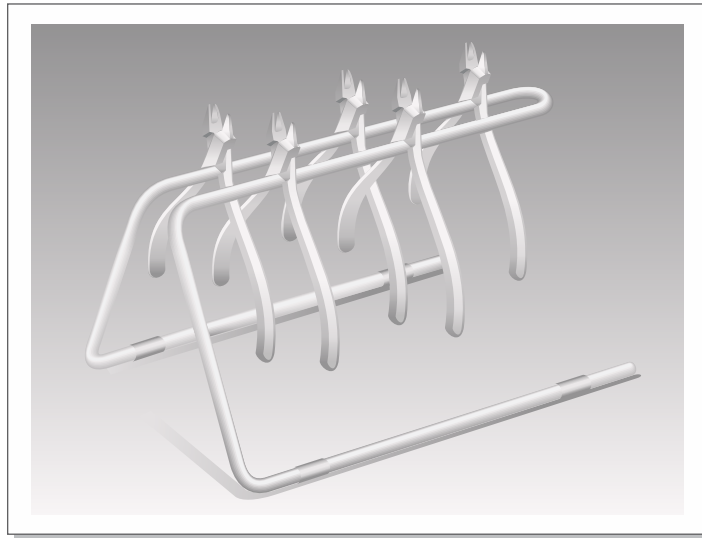


**BOLEY**  
**NMI-DP-730**  
140 mm

0 - 100 mm  
Messbereich  
Measuring range  
Campo di misura  
Rango de  
medición Champ  
de mesure

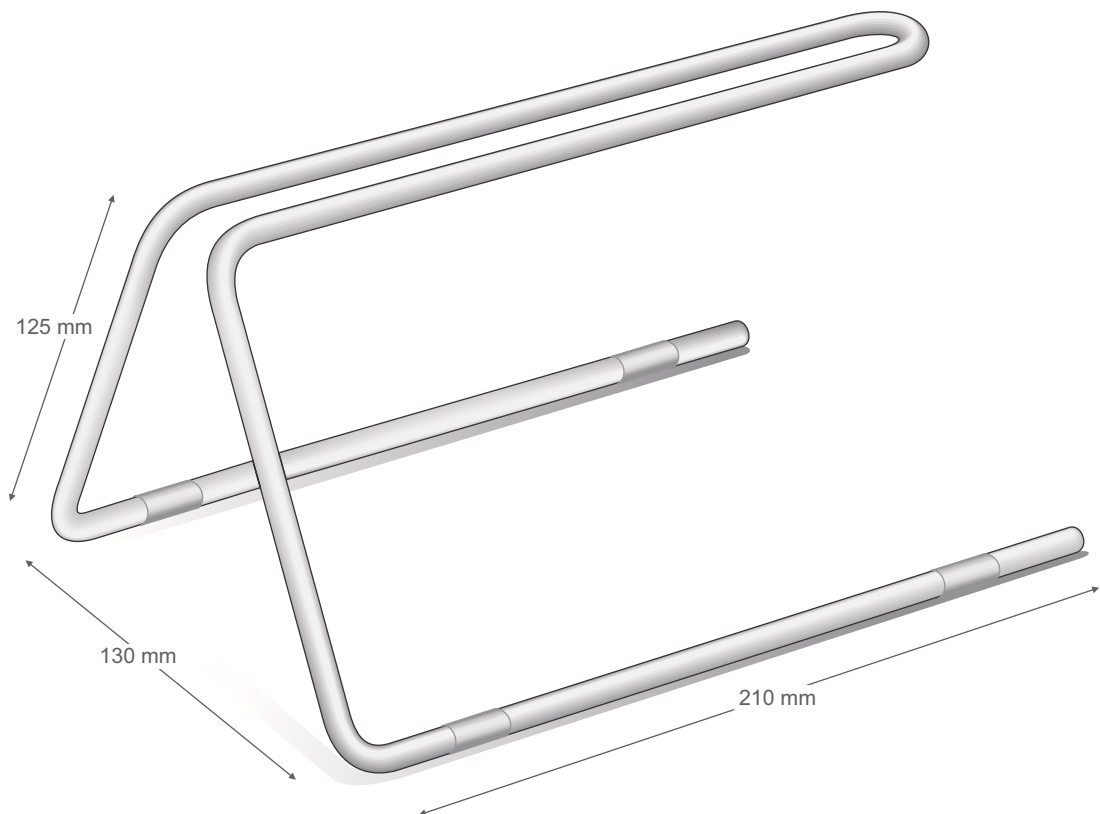


Zubehör  
Accessories  
Accessori  
Accesorios  
Accessoires



Zangenständer  
Plier Stand  
Supporto per pinze  
Soportes para  
alicates Supports de  
pinces

**Stainless Steel**  
Rostfreier Stahl  
Acier inoxydable  
Acero inoxidable  
Acciaio inossidabile



NMI-DP-140

# DENTAL Instruments

Extracting Forceps

Root Elevators

Scalpel Blades and Handles

Surgical Scissors

Tissue and Dressing Forceps

Needle Holders

Hemostatic Forceps | Towel Clamps

Retractors | Mouth Gags

Implantology

Periosteal | Curettes | Rongeurs

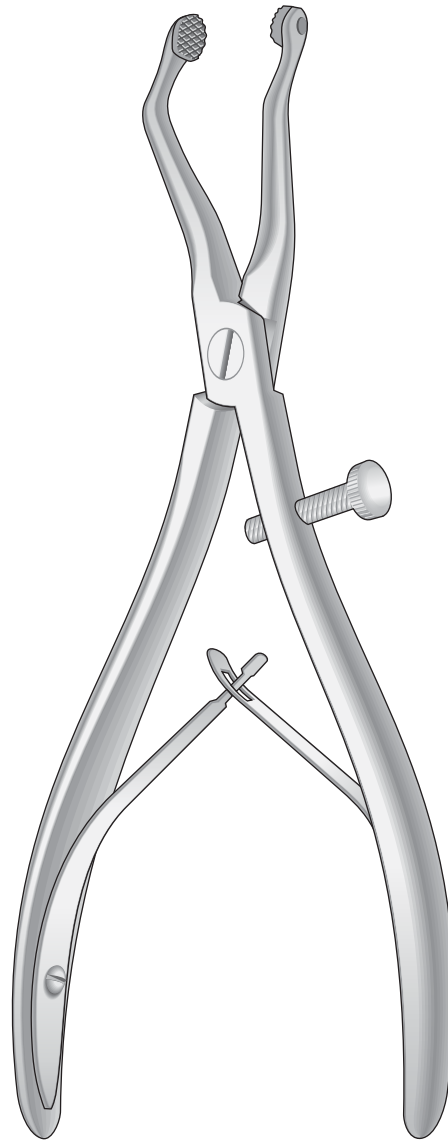
Dental Restoration | Periodontology

Suction Tube

Orthodontics

Crown Instruments | Laboratory

Instrument Maintenance | Sterilization



**321-333**

**Crown Instruments**

Kronenentferner

Enlève-couronne

Removedor de coronas

Leva corone

**Laboratory**

Laboratorium

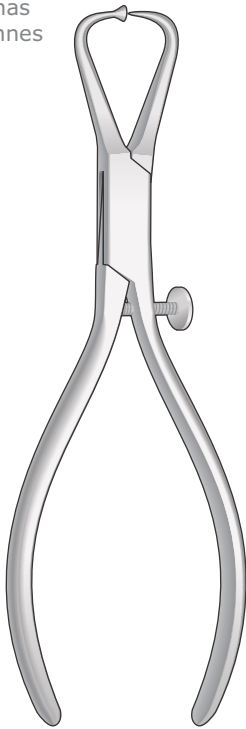
Laboratoire

Laboratorio

Laboratorio

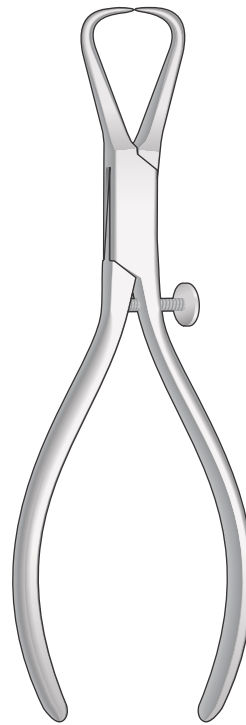


Kroneninstrumente  
Crown Instruments  
Pinze per corone  
Alicates para coronas  
Pinces pour couronnes

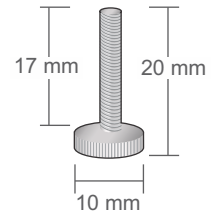


**KERLING**  
**NMI-DP-38A**  
145 mm

Kupferingabnehmezange  
Copper Ring Removing Pliers  
Pinza per togliere anelli di rame  
Pinza para sacar anillos de cobre  
Pince à enlever les bagues en cuivre

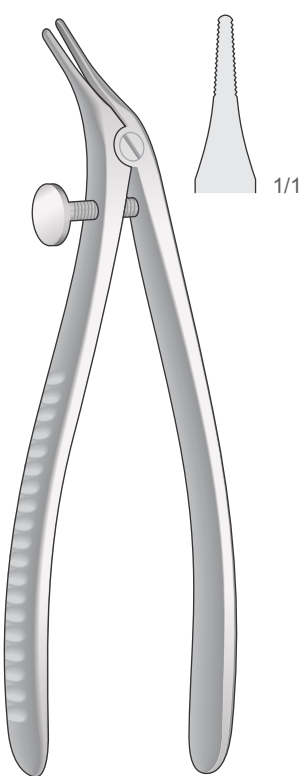


**FURRER**  
**NMI-DP-38**  
145 mm

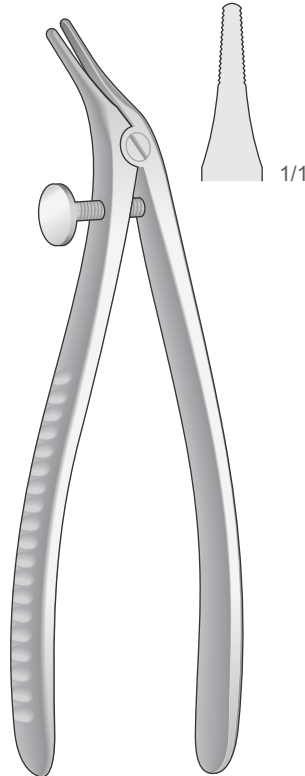


**NMI-DP-38R**  
Schraube  
Replacement Screw  
Vite di ricambio  
Tornillos de recambio  
Vis de rechange

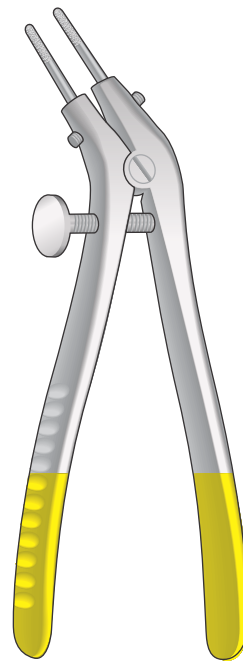
Teleskopkronenzangen - Pliers for telescope crowns  
Pinze per corone telescopiche - Alicates para coronas telescópicas  
Pinces pour couronnes telesopes



**BÖHM**  
**NMI-DP-28**  
150 mm



**BÖHM**  
**NMI-DP-29**  
150 mm



**NMI-DP-24**  
120 mm

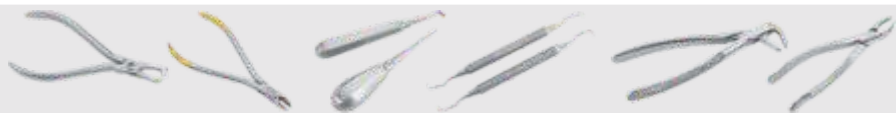


**NMI-DP-24C**  
Schlüssel  
I Key  
Chiavetta  
Llave Clé



**NMI-DP-24R**

Diamantierte Einsätze,  
paar Diamond inserts, pairs  
Punte diamantate, coppia  
Puntas diamantadas, par  
Pointes diamantées, pair

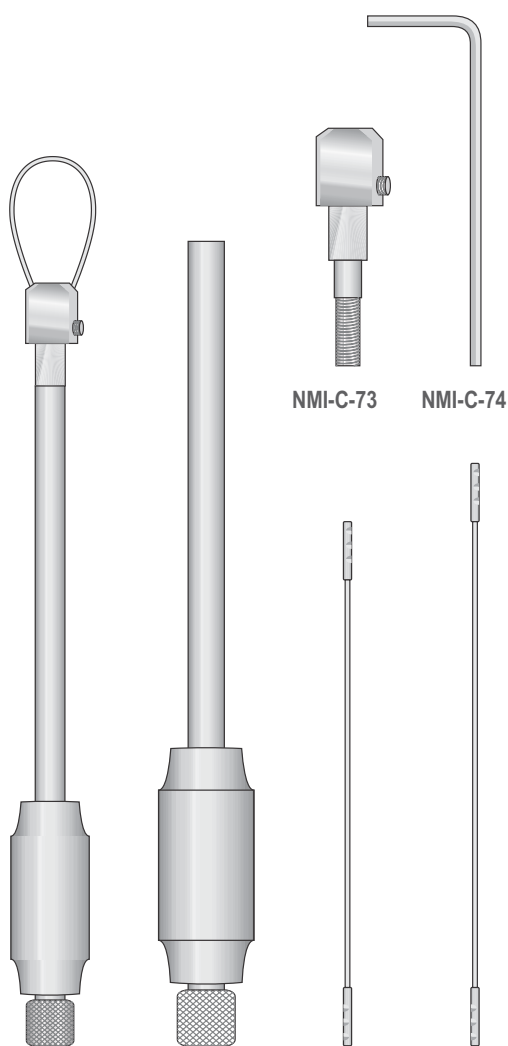


Kronen Instrumente  
Crown Instruments  
Strumenti per corone  
Instrumentos para coronas  
Instruments pour couronnes

**NMI-MRT/C7 BRIDGE-  
EXTRACTOR**

**COMPLETE SET**

NMI-MRT-7 + NMI-C-71 + NMI-C-72  
+ NMI-C-73 + NMI-C-74

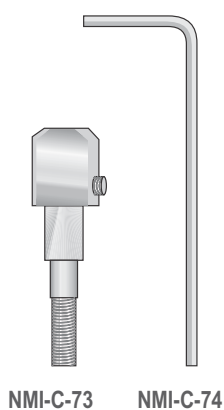


NMI-MRT/C7

NMI-MRT-7

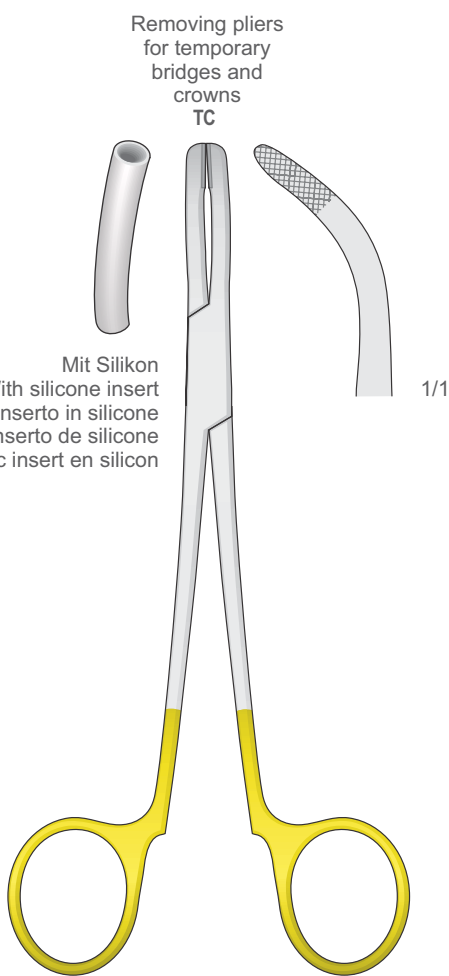
NMI-C-71  
70 mm

NMI-C-72  
80 mm



NMI-C-73

NMI-C-74

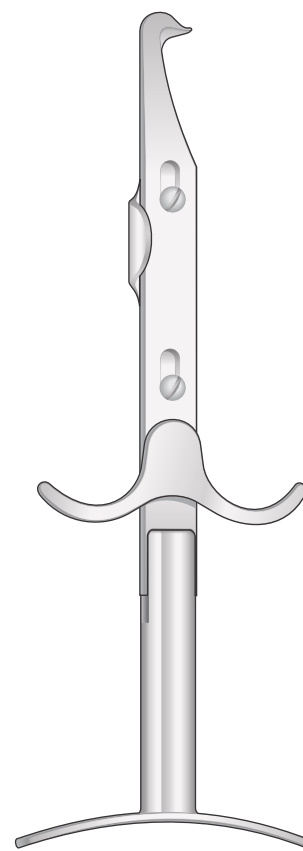


Removing pliers  
for temporary  
bridges and  
crowns  
TC

Mit Silikon  
With silicone insert  
Con inserto in silicone  
Con inserto de silicone  
Avec insert en silicon

1/1

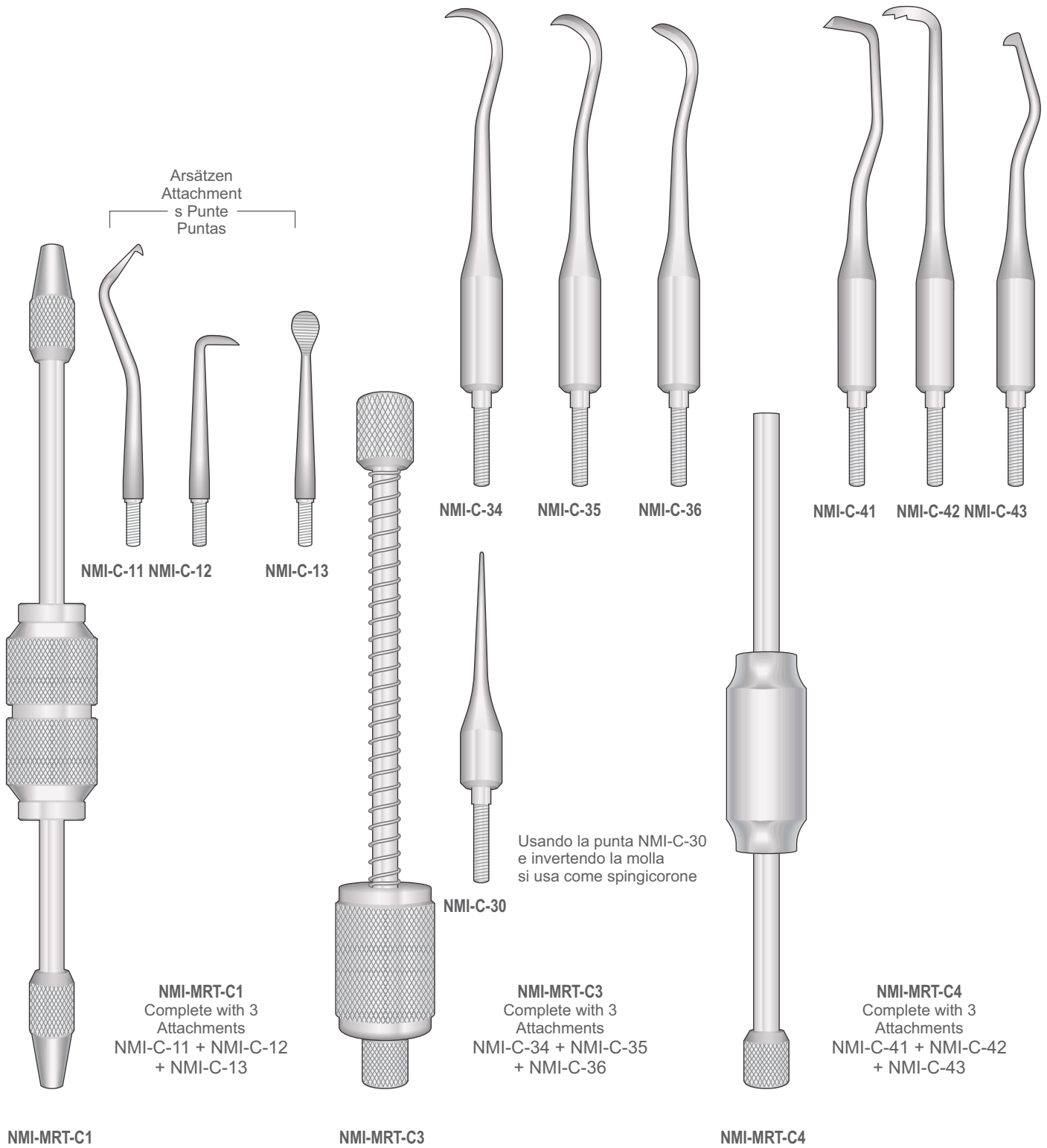
NMI-PH-60  
170 mm

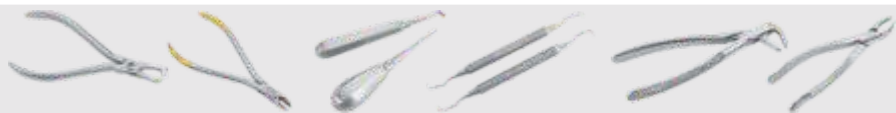


NMI-MRT-6  
170 mm



Kronentferner  
Crown Removers  
Leva corone  
Removedor de coronas  
Enlève-couronne





Kronenentferner  
Crown Removers  
Leva corone  
Removedor de coronas



**NMI-DL-C**  
140 mm



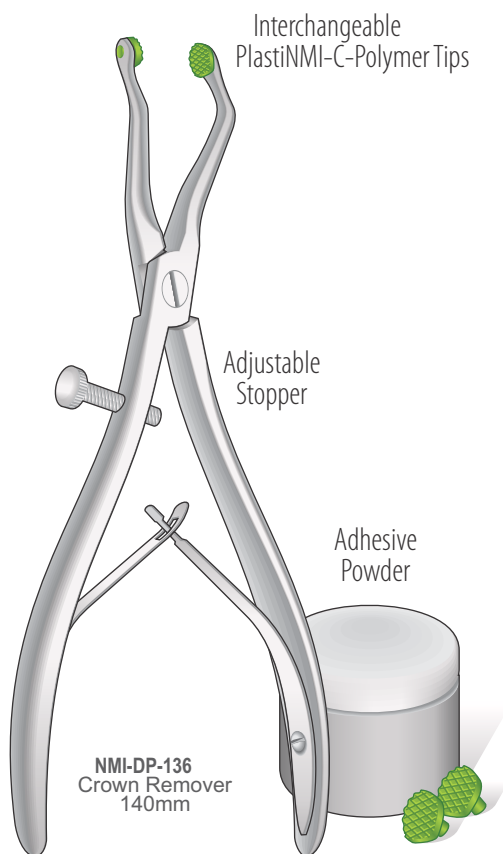
**UNIVERSA  
L NMI-DL-60**  
150 mm



**NMI-DL-V**  
130 mm



**NMI-DL-0**  
130 mm

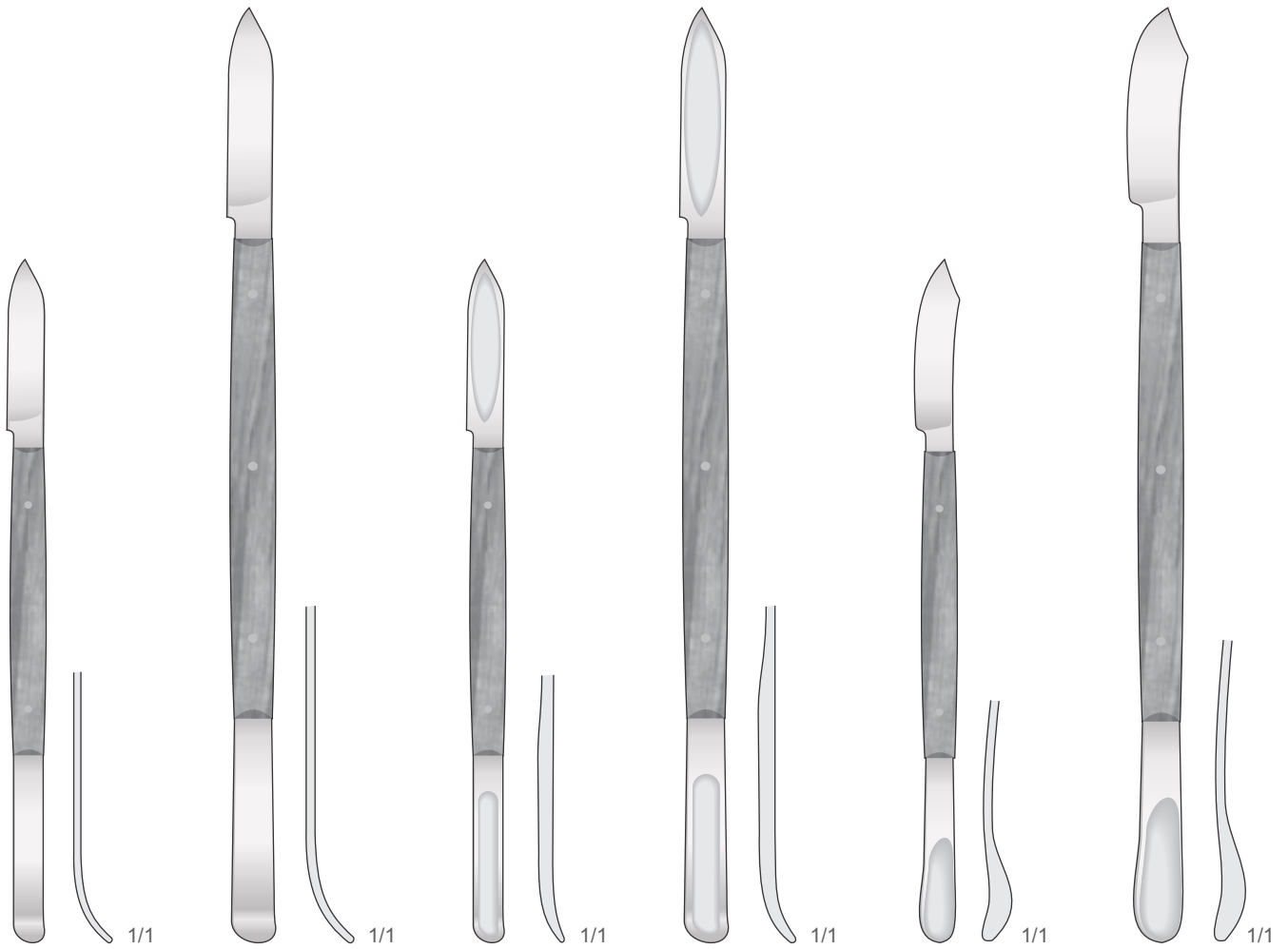


- NMI-DP-136**  
**Crown Remover Set**  
1 Crown Remover+ 10 Pairs of PlastiNMI-C-Polymer Tips + 10g Adhesive Powder  
**Kronenentferner Set**  
1 Kronenaufweitzange + 10 Paar Kunststoff-Polymer-Tipps + 10g Pulverkleber  
**Set Enlève-Couronne**  
1 Pince à détacher les couronnes + 10 Paires de pointes de polymère plastique + 10g Adhésif en poudre  
**Set Removedor de Coronas**  
1 Pinza para quitar coronas + 10 Pares de puntas de polímero plástico+ 10g Polvo adhesivo  
**Set Leva Corone**

- NMI-DP-137**  
**Replacement Kit:** 10 Pairs of PlastiNMI-C-Polymer Tips + 10g Adhesive Powder  
Ersatz-Kit: 10 Paar Kunststoff-Polymer-Tipps + 10g Pulverkleber  
Kit de rechange: 10 Paires de pointes de polymère plastique + 10g Adhésif en poudre  
Kit de recambio: 10 Pares de puntas de polímero plástico+ 10g Polvo adhesivo  
Kit di ricambio: 10 Coppie di inserti in plastica + 10 g Polvere adesiva



Wachsmesser  
Wax Knives  
Coltelli per cera  
Cuchillos para cera  
Couteaux à cire



FAHNENSTOCK  
NMI-CP

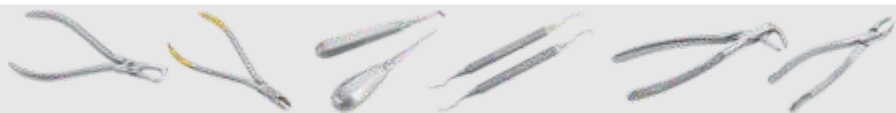
FAHNENSTOCK  
NMI-CG

LESSMANN  
NMI-CPL

LESSMANN  
NMI-CGL

NMI-CPS

NMI-CGS



Spatel Spatulas Spatole  
Espátulas Spatules

Spatulas for plaster and alginate  
Spatole per alginato e gesso

Flexible  
Flexibel  
Flexible  
Flexible  
Flessibile

Rigid  
Fest  
Rigide  
Rígido  
Rigido



**GRITMAN**  
**NMI-CM**  
175 mm



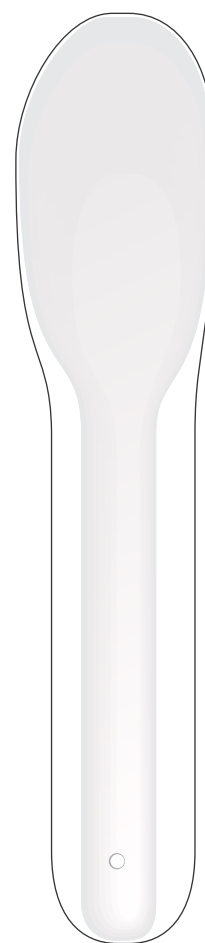
**NMI-SA-1**  
200 mm



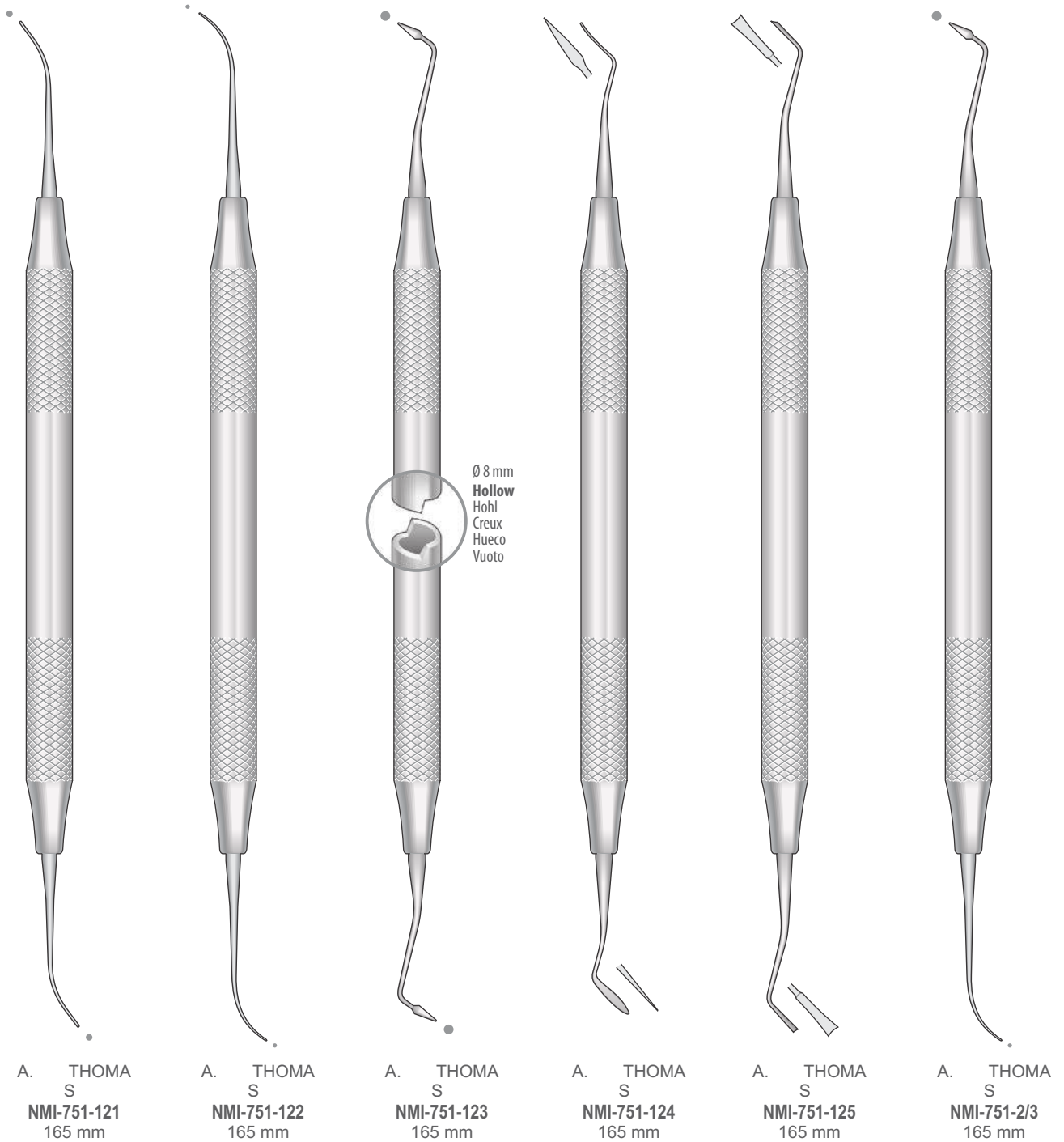
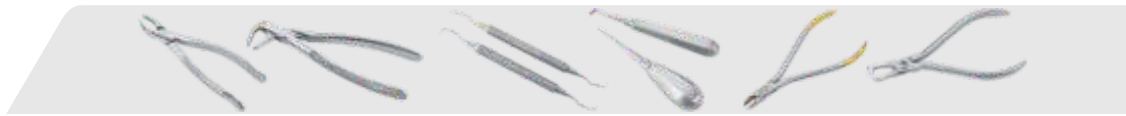
**NMI-SA-2**  
200 mm

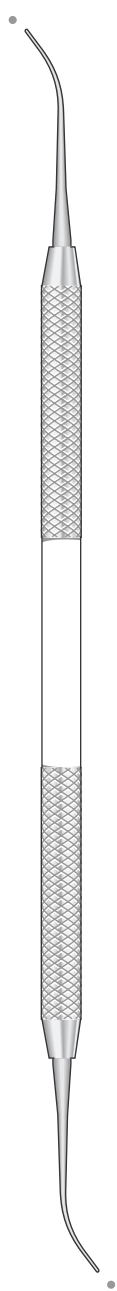
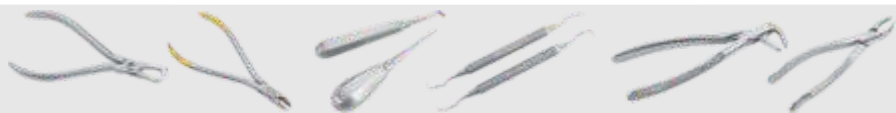


**NMI-SA-3**  
200 mm

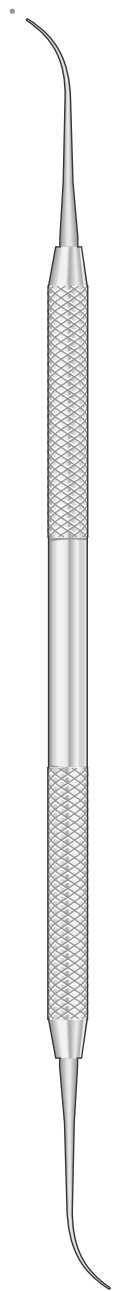


**NMI-S18-8**  
185 mm

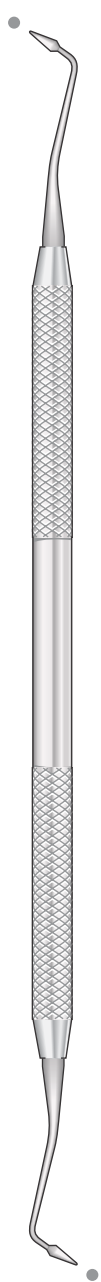




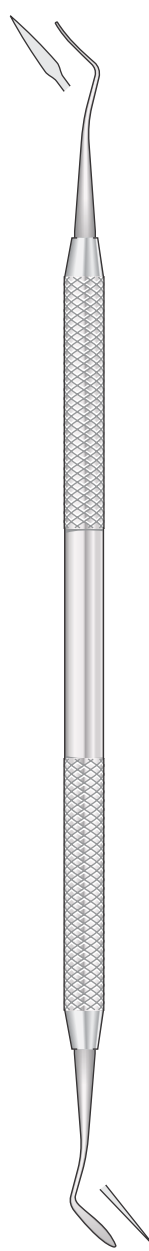
A. THOMA  
S  
NMI-PT-1  
165 mm



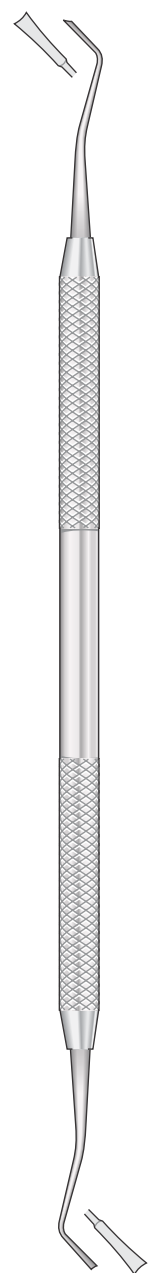
A. THOMA  
S  
NMI-PT-2  
165 mm



A. THOMA  
S  
NMI-PT-3  
165 mm



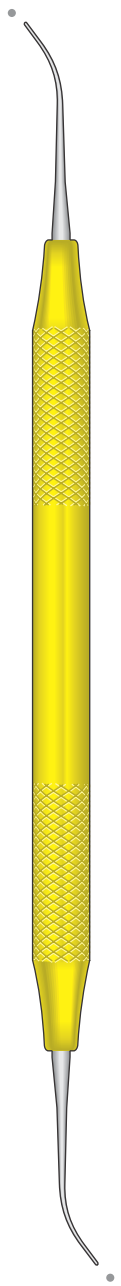
A. THOMA  
S  
NMI-PT-4  
165 mm



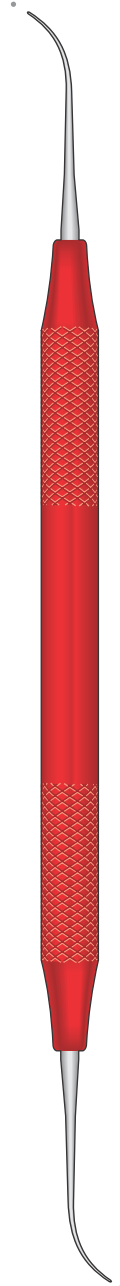
A. THOMA  
S  
NMI-PT-5  
165 mm



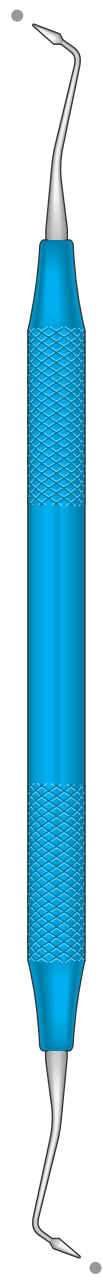
Aluminium  
Aluminium  
Aluminium  
Aluminio  
Alluminio



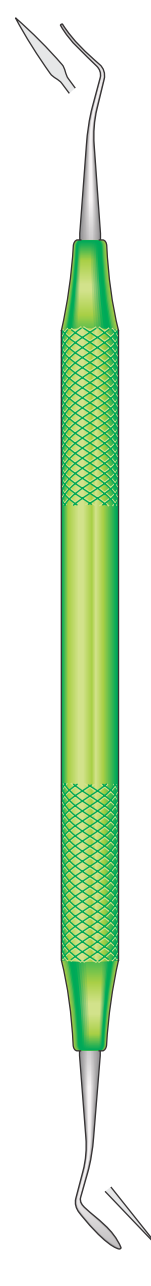
A. THOM  
AS  
NMI-AL-PT1  
165 mm



A. THOM  
AS  
NMI-AL-PT2  
165 mm



A. THOM  
AS  
NMI-AL-PT3  
165 mm

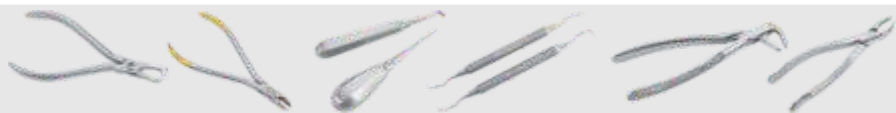


A. THOM  
AS  
NMI-AL-PT4  
165 mm

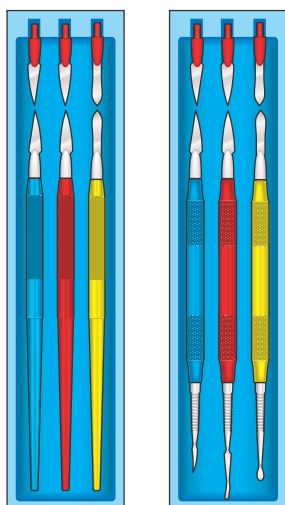


A. THOM  
AS  
NMI-AL-PT5  
165 mm

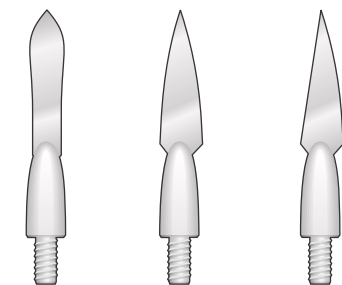
Ø 8 mm  
Hollow  
Hohl  
Creux  
Hueco  
Vuoto



Modellierinstrumente für Keramik  
Ceramic Sculpturing Instruments  
Strumenti per ceramica  
Instrumentos para modelar la cerámica  
Instruments à modeler la céramique

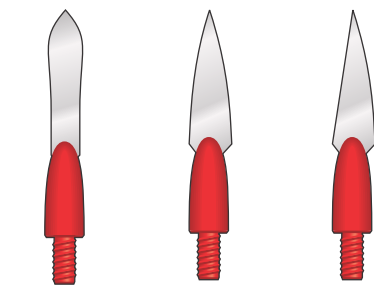


Biegsam - Flexible  
Flessibili -  
Flexibles Flexibles



NMI-CL-1B NMI-CL-2B NMI-CL-3B

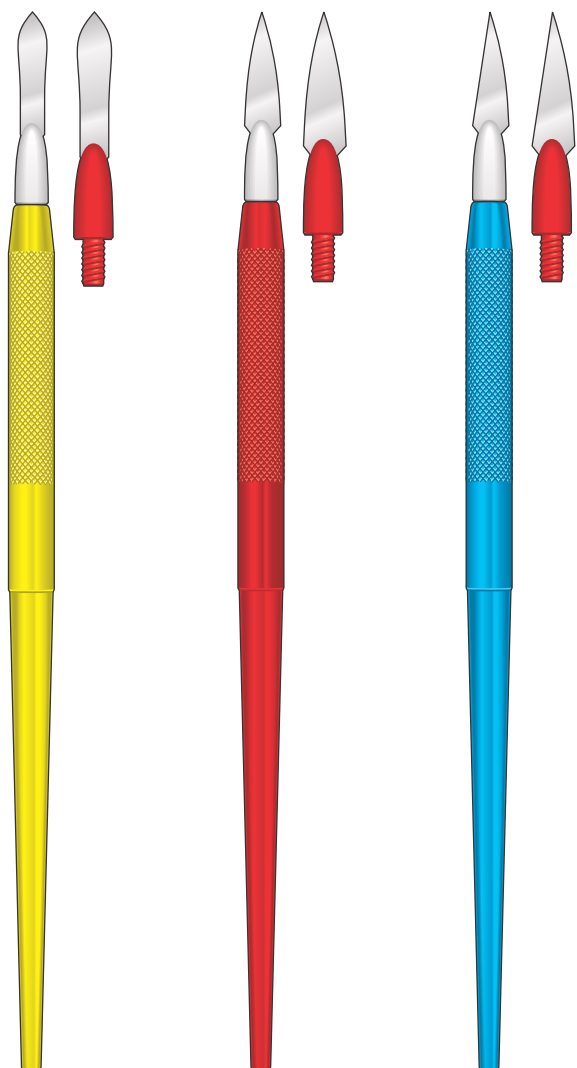
Superbiegsam - Superflexible  
Superflessibili -  
Superflexibles Superflexibles



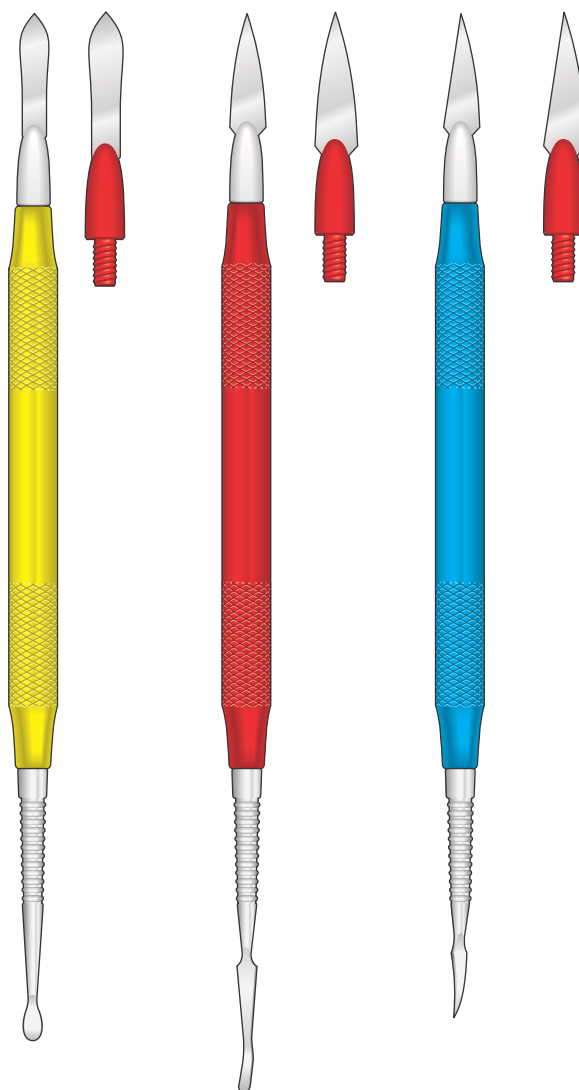
NMI-CL-1R NMI-CL-2R NMI-CL-3R

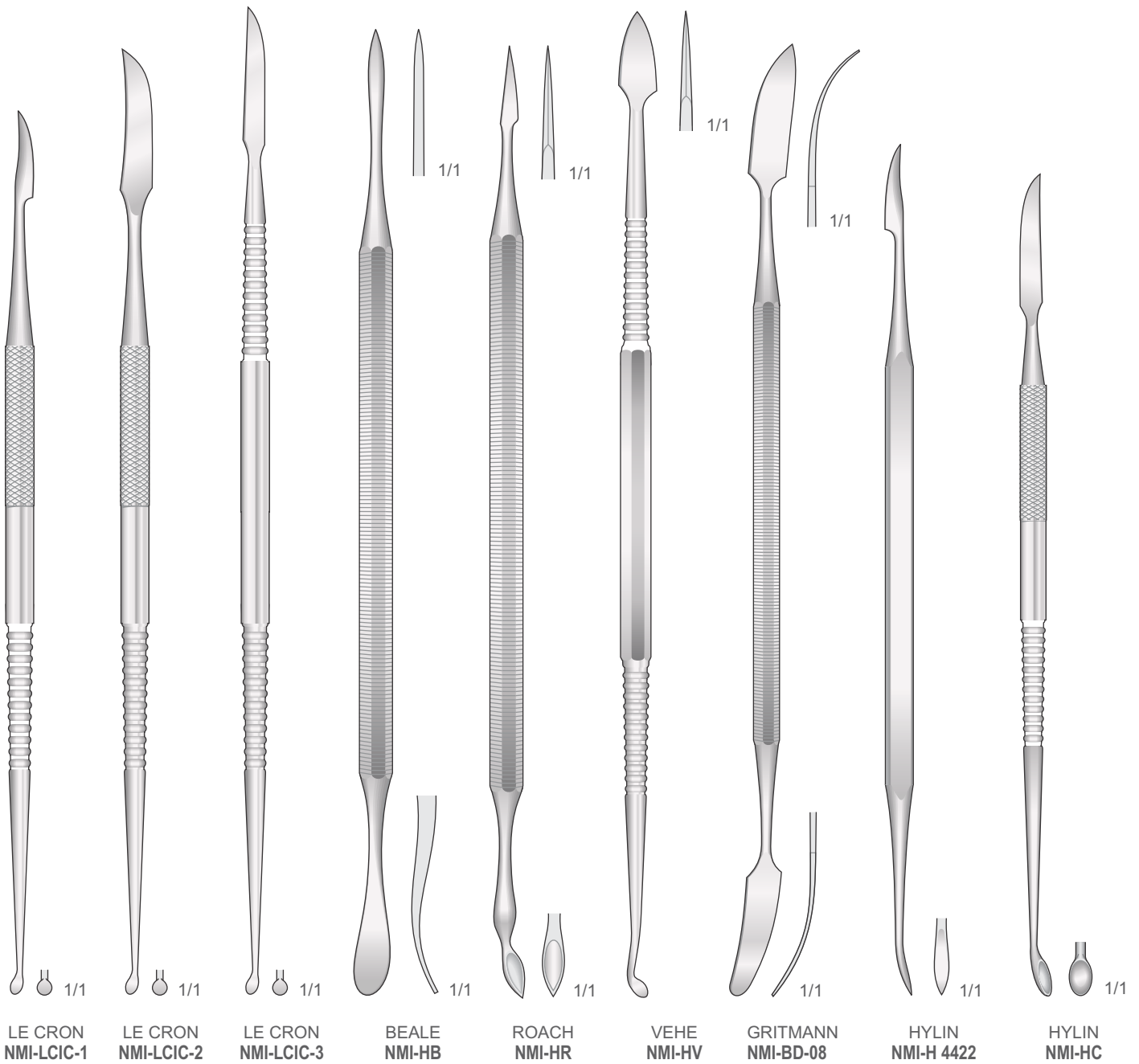
Aluminium  
Aluminium  
Aluminium  
Aluminio  
Alluminio

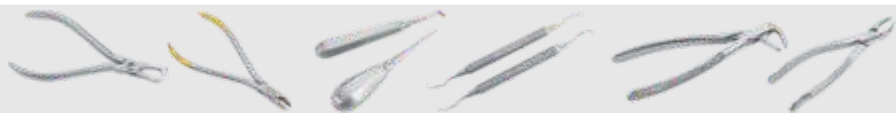
NMI-AL-SETC/1



NMI-AL-SETC/2







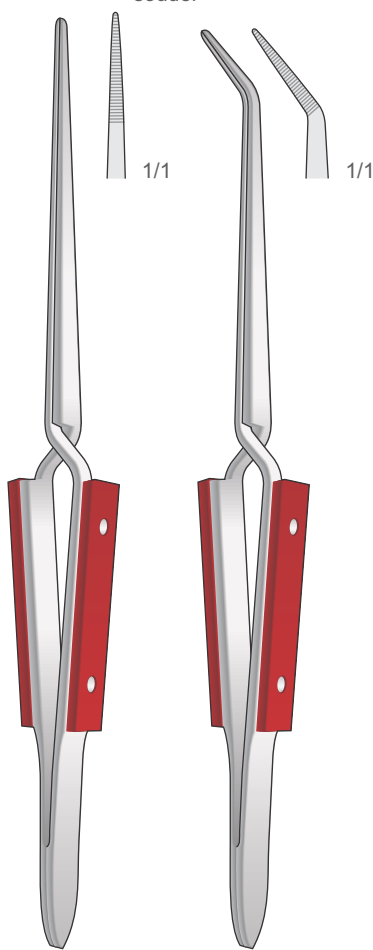
Instrumente für Laboratorium  
Instruments for laboratory  
Strumenti da laboratorio  
Instrumentos para  
laboratorio Instruments pour

Gipsschneidezange  
Plaster cutting pliers  
Cesoia taglia gesso  
Alicates para cortar  
yeso Pince à couper le  
piâtre



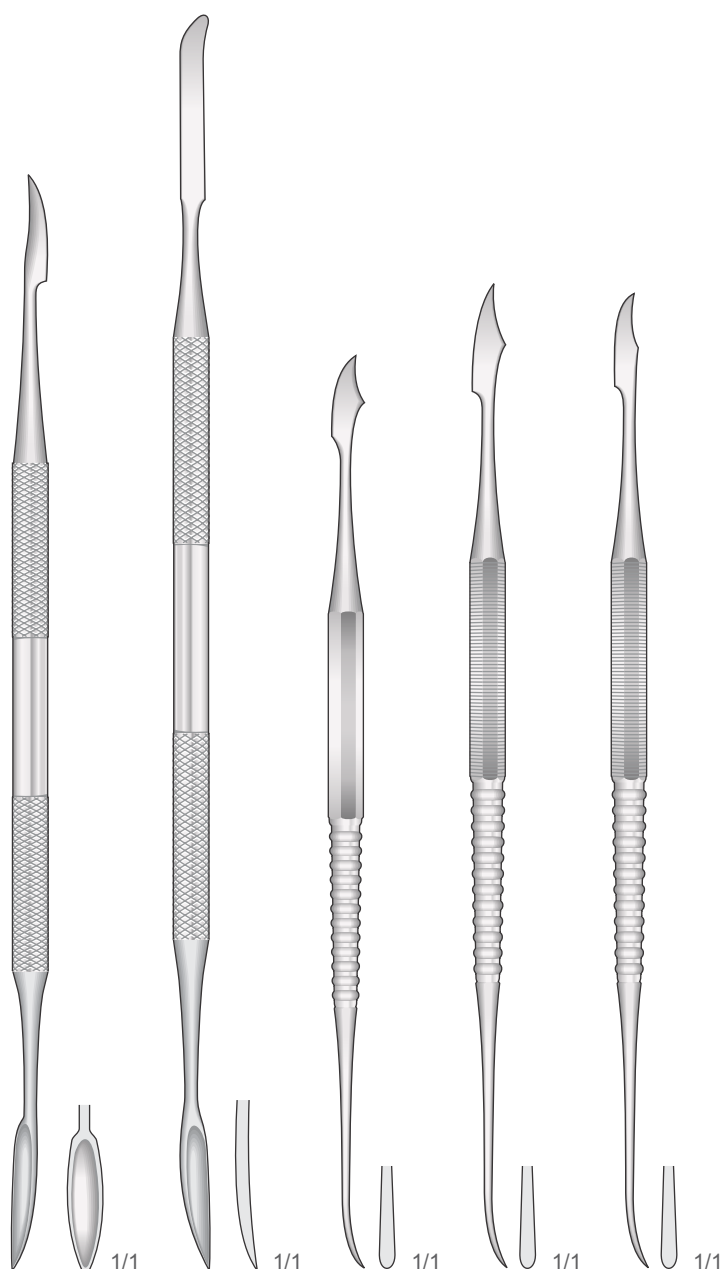
1/1

Lötpinzetten  
Soldering tweezers  
Pinzette per  
saldare Pinzas para  
soldar Précelles à  
souder



1/1

1/1



1/1

1/1

1/1

1/1

1/1

**HYLIN  
NMI-HA**

**HYLIN  
NMI-HL**

**ZAHLE  
NMI-Z-1**

**ZAHLE  
NMI-Z-2**

**ZAHLE  
NMI-Z-3**

**NMI-PS-1  
170 mm**

**NMI-PS-2  
165 mm**

**NMI-BK-30  
210 mm**



# DENTAL Instruments

Extracting Forceps

Root Elevators

Scalpel Blades and Handles

Surgical Scissors

Tissue and Dressing Forceps

Needle Holders

Hemostatic Forceps | Towel Clamps

Retractors | Mouth Gags

Implantology

Periosteal | Curettes | Rongeurs

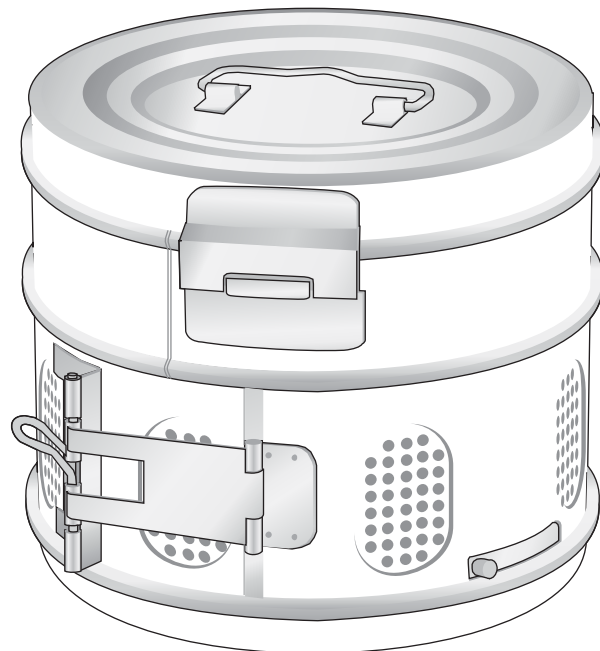
Dental Restoration | Periodontology

Suction Tube

Orthodontics

Crown Instruments | Laboratory

Instrument Maintenance | Sterilization



## 334-344

**Instrument Maintenance**

Instrumentenwartung

Entretien des instruments

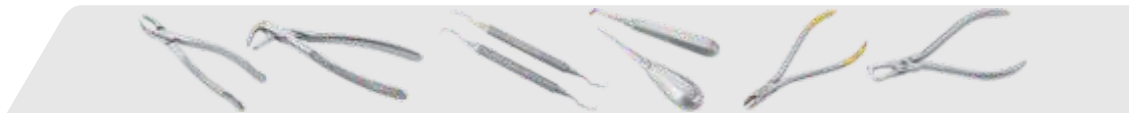
Mantenimiento de

instrumentos Manutenzione

degli strumenti **Sterilization**

Sterilisierung Stérilisation

Esterilización Sterilizzazione



Gefäße aus Edelstahl  
Stainless Steel Receptacles  
Recipienti in acciaio inossidabile  
Recipientes de acero inoxidable  
Réipients en acier inoxydable

Nadeldose  
Needle case  
Scatola per aghi  
Caja para agujas  
Boîte á aiguilles



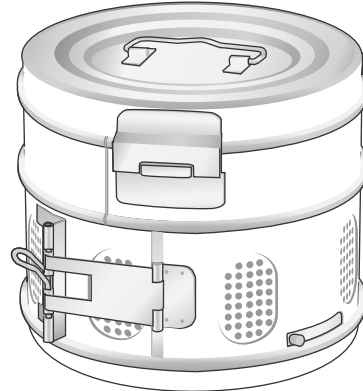
**NMI-BS-1**  
Ø 78 mm h 15 mm

Nierenschalen  
Kidney bowls  
Bacinelle reniformi  
Rifoneras  
Bassins  
réniformes



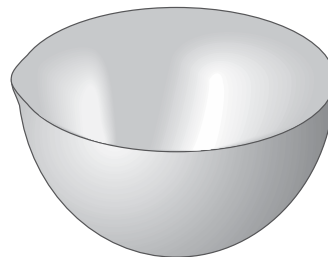
**NMI-BR-20** 200 mm  
**NMI-BR-25** 250 mm  
**NMI-BR-28** 280 mm

Verbandstofftrommeln  
Dressing sterilizing  
drums Cestelli cilindrici  
Caja para esterilización



**NMI-CS-12** 125x125 mm  
**NMI-CS-15** 150x150 mm  
**NMI-CS-19** 190x145 mm

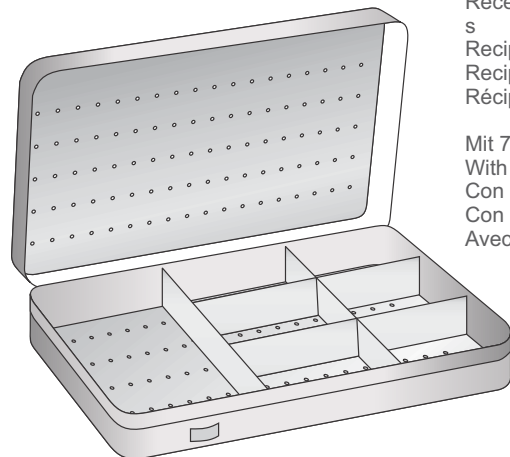
Runder Sterilbehälter mit Ausguss  
Round sterile bowl  
Capsule inox con fondo piano e  
becco Cubetas de acero inoxidable  
Cuvettes de acier inoxydable



**NMI-CS-01** Ø 40 mm 15 cc  
**NMI-CS-02** Ø 60 mm 75 cc  
**NMI-CS-03** Ø 60 mm 75 cc  
**NMI-CS-04** Ø 100 mm 325 cc  
**NMI-CS-05** Ø 120 mm 500 cc



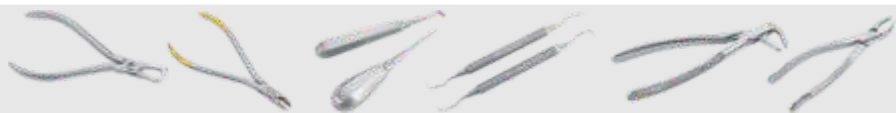
**NMI-BS-32**  
180 x 85 x 20 mm



**NMI-BS-27**  
150 x 90 x 20 mm

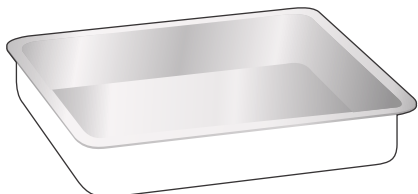
Gefäße  
Receptacles  
Recipientes  
Recipientes  
Réipients

Mit 7 box  
With 7 box  
Con 7 box  
Con 7 box  
Avec 7 box

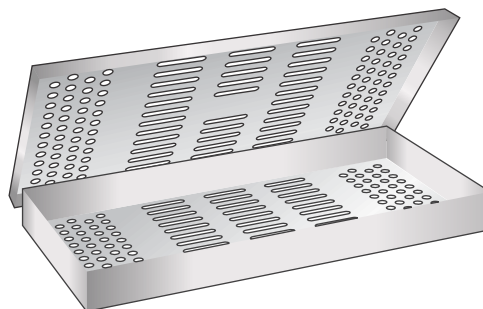


Steril Container  
Sterilization Container  
Contenitori per sterilizzazione  
Contenedores para esterilización  
Conteneurs pour stérilisation

Schalen  
Trays  
Vassoi  
Bandejas  
s  
Bassins

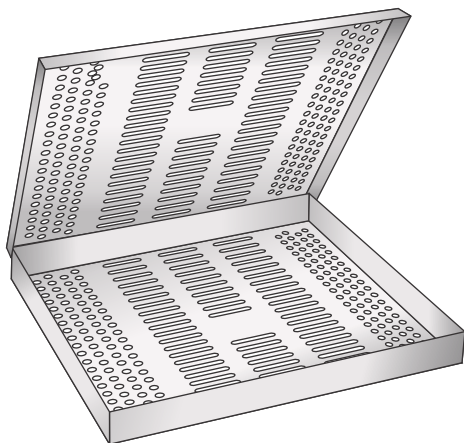


**NMI-VS-20** 210 x 110 x 25 mm  
**NMI-VS-26** 250 x 180 x 30 mm  
**NMI-VS-30** 300 x 220 x 30 mm

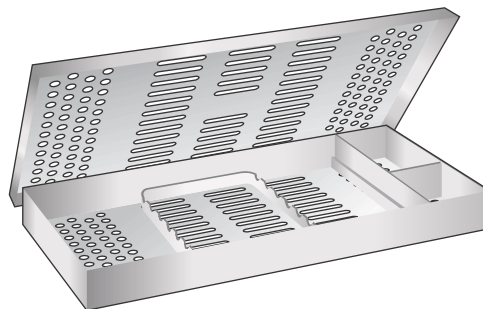


**NMI-BS-41**  
275 x 130 x 25 mm

Mit Instrumentehalter und box  
With Insert frames and box  
Con griglia e scomparti  
Con porta instrumentos y box  
Avec Porte instruments et box



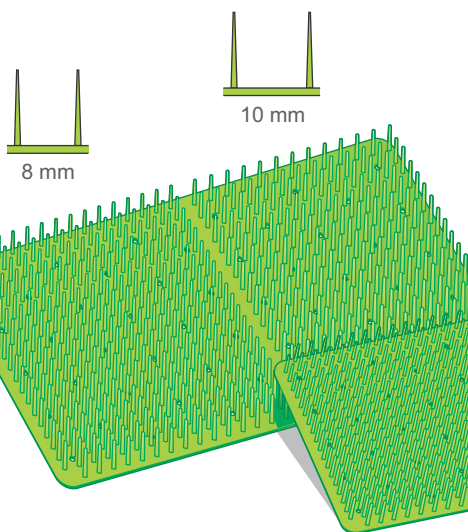
**NMI-BS-43**  
285 x 190 x 25 mm



**NMI-BS-40** 275x130x25mm  
**NMI-BS-42** 285x190x25mm

Silicon Mat  
Silikon  
Noppenmatten  
Tappeti di silicone  
Tapiz de silicona  
Tapis en silicone

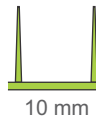
Autoklav  
Autoclavable  
Autoclavabile  
Autoclave Autoclave



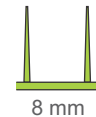
**NMI-TS-104**  
270 x 180 mm



**NMI-TS-103**  
260 x 120 mm



**NMI-TS-102**  
135 x 180 mm

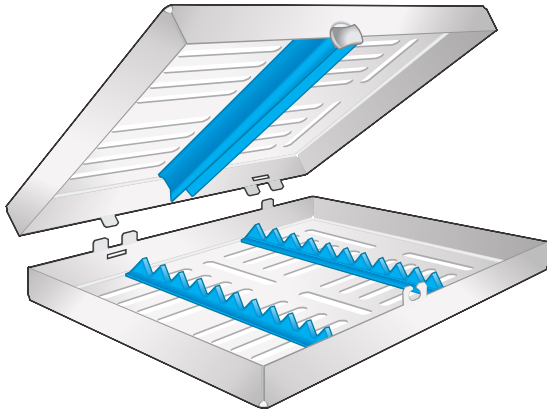


**NMI-TS-101**  
135 x 180 mm

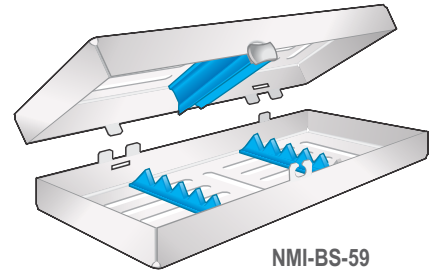


Steril Container  
Sterilization Container  
Contenitori per sterilizzazione  
Contenedores para esterilización  
Conteneurs pour

Rostfreier Stahl Sterilcontainer mit Silikonereinrichtung  
Stainless Steel Sterilization Containers with silicone racks  
Contenitori per sterilizzazione in acciaio inossidabile con griglia in silicone  
Contenedores para esterilización en acero inoxidable con soportes en silicona  
Containers pour stérilisation en acier inoxydable avec des supports de silicone



**NMI-BS-60**  
185 x 135 x 35 mm  
For 10 Instruments  
**NMI-BS-61**  
290 x 185 x 35 mm  
For 20 Instruments



**NMI-BS-59**  
185 x 75 x 35 mm  
For 5 Instruments

**CT-555**  
**CT-560**  
**CT-565**

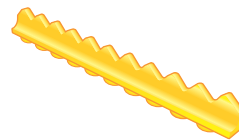


**Sterilcontainer,**  
mit Deckel- und Bodenperforation,  
passend in gängige Praxisautoklaven  
**Containers for sterilization,**  
with perforation in lid and bottom,  
suitable for common practice autoclaves  
**Contenitori dentali,**  
con coperchio e fondo perforato,  
adatti a tutte le autoclavi comuni  
**Contenedores dentales,**  
con tapa y fondo perforados,  
aptos para autoclaves habituales  
**Containers stérile,**  
avec perforation du couvercle et du  
fond, convenant aux autoclaves  
courants

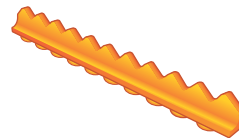
**CT-651**  
**CT-652**  
**CT-653**



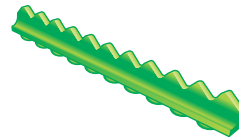
Silikonereinrichtung für Tray  
Silicone Racks for Tray  
Griglia in Silicone per Tray  
Equipo de silicona para Tray  
Aménagement en silicone pour Tary



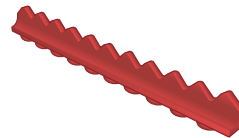
**TRANSLUCENT YELLOW**  
**NMI-SIL-01**  
130 mm



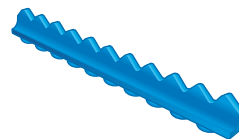
**ORANGE**  
**NMI-SIL-02**  
130 mm



**TRANSLUCENT GREEN**  
**NMI-SIL-03**  
130 mm



**RUST RED**  
**NMI-SIL-04**  
130 mm



**BLUE**  
**NMI-SIL-05**  
130 mm

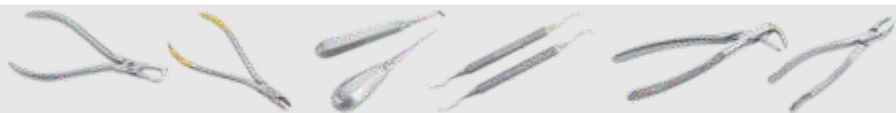


**CT-555**  
300 x 140 x 40 mm  
**CT-651**  
310 x 190 x 40 mm

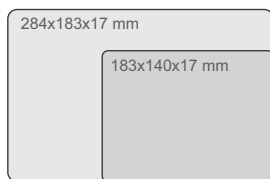
**CT-560**  
300 x 140 x 70 mm  
**CT-652**  
310 x 190 x 65 mm

**CT-565**  
300 x 140 x 100 mm  
**CT-653**  
310 x 190 x 130 mm

Alu  
Aluminiu  
m  
Alluminio  
Aluminio

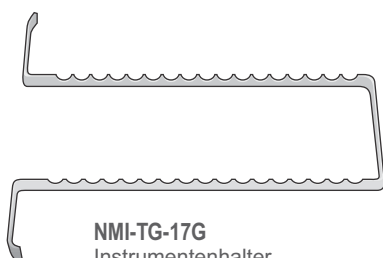


Aluminium-Tray  
Aluminium Trays  
Tray in alluminio  
Bandejas de aluminio  
Boîtes en aluminium



Farbcodiert-Tray-Unterteile für 17 instrumente  
Color-Coded bases for 17 instruments  
Vassoio colorati per 17 strumenti  
Bandejas en colores para 17 instrumentos  
Plateaux colorés pour 17 instruments

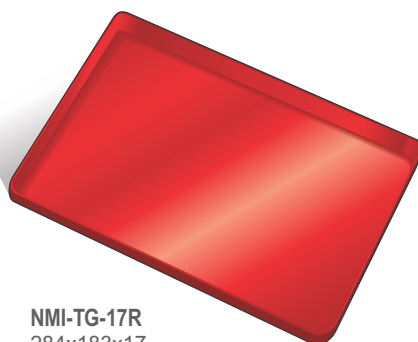
Für 17 instrumente For 17 instruments Per 17  
strumenti  
Para 17 instrumentos Pour 17 instruments



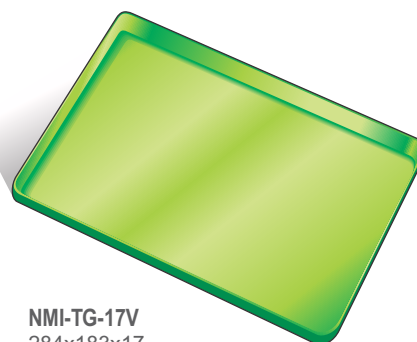
**NMI-TG-17G**  
Instrumentenhalter  
Insert frames  
Griglia  
Portastrumenti Porta  
instrumentos Porte  
instruments



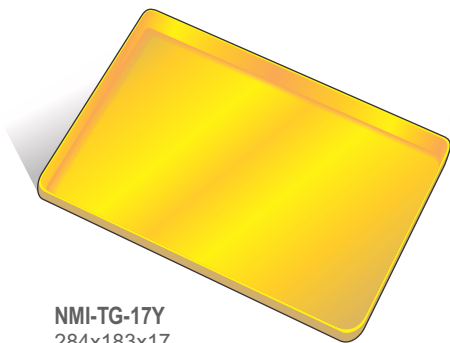
**NMI-TG-17A**  
284x183x17  
mm Unterteile  
allein Only base  
Vassoio solo  
Bandeja suelta  
Plateau seul



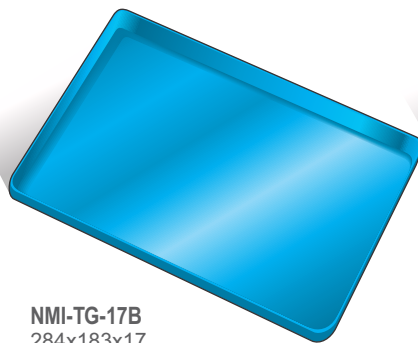
**NMI-TG-17R**  
284x183x17  
mm Unterteile  
allein Only base  
Vassoio solo  
Bandeja suelta  
Plateau seul



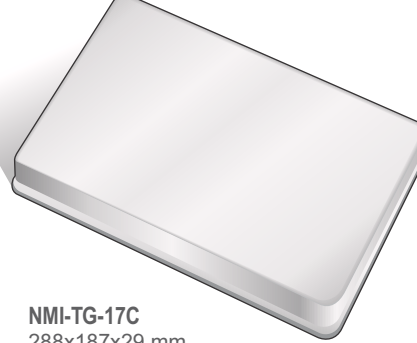
**NMI-TG-17V**  
284x183x17  
mm Unterteile  
allein Only base  
Vassoio solo  
Bandeja suelta  
Plateau seul



**NMI-TG-17Y**  
284x183x17  
mm Unterteile  
allein Only base  
Vassoio solo  
Bandeja suelta  
Plateau seul



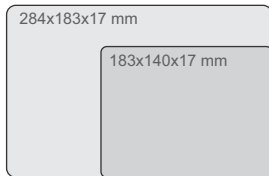
**NMI-TG-17B**  
284x183x17  
mm Unterteile  
allein Only base  
Vassoio solo  
Bandeja suelta  
Plateau seul



**NMI-TG-17C**  
288x187x29 mm  
Tray-Deckel, grau  
Lid - Grey only  
Coperchio - Solo argento  
Tapa en color gris  
Couvercle - seulement en  
gris

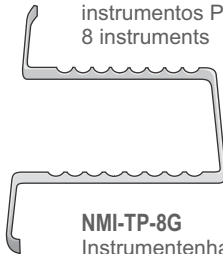


Aluminium MIDI Tray  
Aluminium MIDI Trays  
Tray in alluminio, misura MIDI  
Bandejas de aluminio, tamaño MIDI  
Boîtes en aluminium, format MIDI

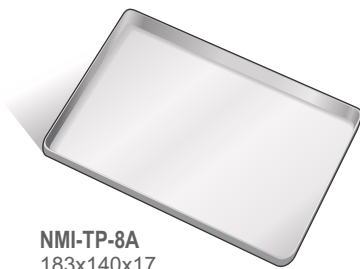
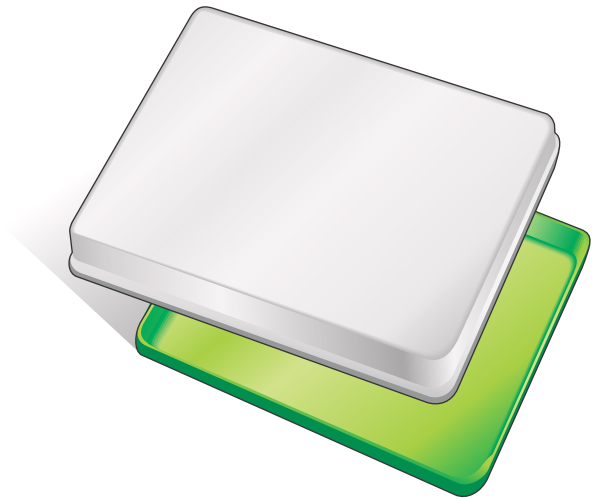


Farbcodiert-Tray-Unterteile für 8 instrumente  
Color-Coded bases for 8 instruments  
Vassoio colorati per 8 strumenti  
Bandejas en colores para 8 instrumentos  
Plateaux colorés pour 8 instruments

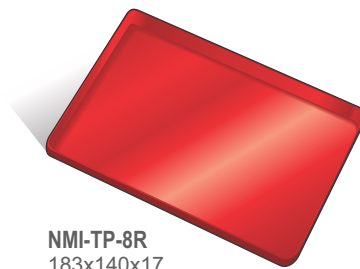
Für 8 instrumente  
For 8 instruments  
Per 8 strumenti  
Para 8  
instrumentos Pour  
8 instruments



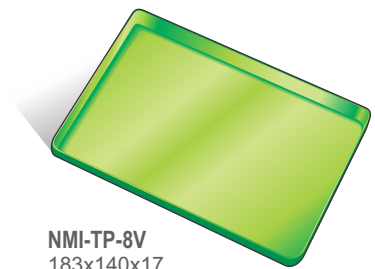
**NMI-TP-8G**  
Instrumentenhalter  
Insert frames  
Griglia  
Portastrumenti Porta  
instrumentos Porte  
instruments



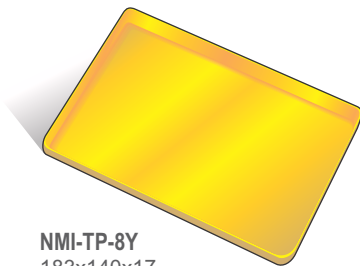
**NMI-TP-8A**  
183x140x17  
mm Unterteile  
allein Only base  
Vassoio solo  
Bandeja suelta  
Plateau seul



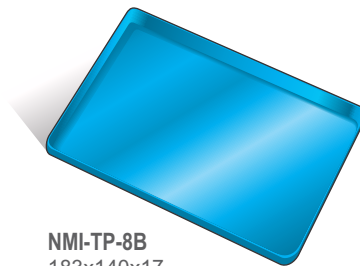
**NMI-TP-8R**  
183x140x17  
mm Unterteile  
allein Only base  
Vassoio solo  
Bandeja suelta  
Plateau seul



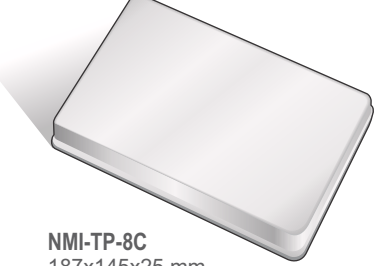
**NMI-TP-8V**  
183x140x17  
mm Unterteile  
allein Only base  
Vassoio solo  
Bandeja suelta  
Plateau seul



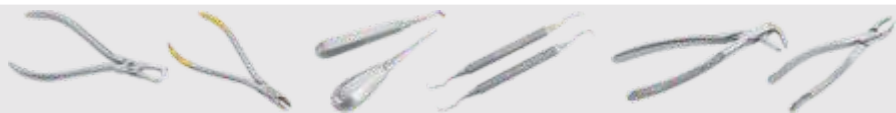
**NMI-TP-8Y**  
183x140x17  
mm Unterteile  
allein Only base  
Vassoio solo  
Bandeja suelta  
Plateau seul



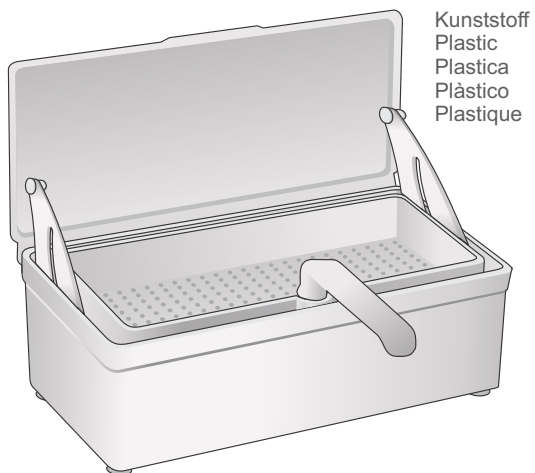
**NMI-TP-8B**  
183x140x17  
mm Unterteile  
allein Only base  
Vassoio solo  
Bandeja suelta  
Plateau seul



**NMI-TP-8C**  
187x145x25 mm  
Tray-Deckel, grau  
Lid - Grey only  
Coperchio - Solo argento  
Tapa en color gris  
Couvercle - seulement en  
gris

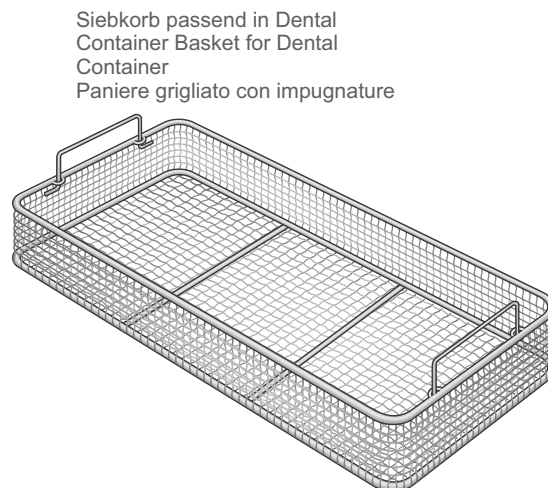


Steril Container  
Sterilization Container  
Contenitori per sterilizzazione  
Contenedores para esterilización  
Conteneurs pour stérilisation



Kunststoff  
Plastic  
Plastica  
Plàstico  
Plastique

**NMI-BS-100**  
255 x 105 x 85 mm

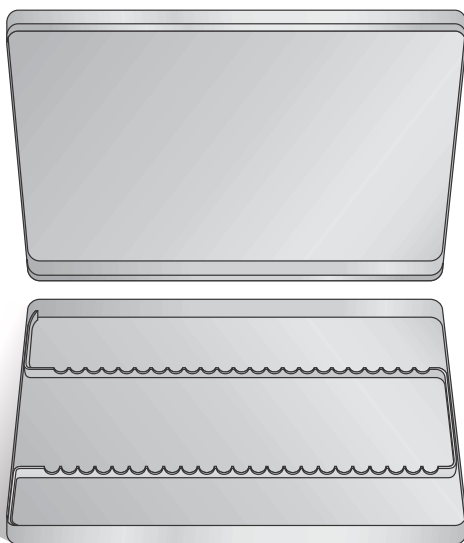


Siebkorb passend in Dental  
Container Basket for Dental  
Container  
Paniere grigliato con impugnature

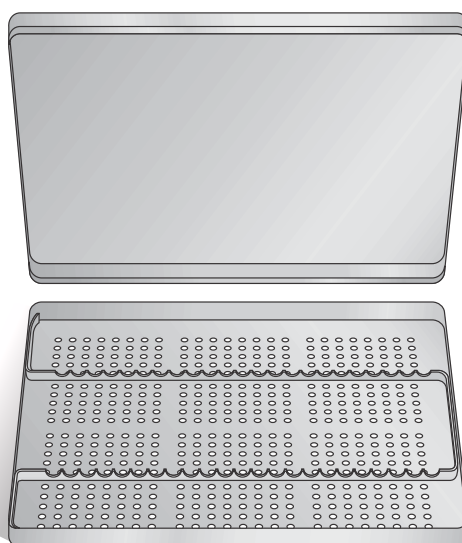
**NMI-NMI-CT-650**  
265 x 120 x 45 mm

**Rostfrei - Stainless steel - Inox - Inoxidable - Inoxydable**

Norm-tray complet mit tray-unterteile, deckel und instrumentenhalter für 23 instrumente  
Instrument tray complete with base, lid and insert frame for 23 instruments  
Portastrumenti completo di vassoio, coperchio e griglia per 23 strumenti  
Bandeja completa de tapa y porta instrumentos para 23 instrumentos  
Boite complete avec plateau et couvercle pour 23 instruments



TRAY INOX  
**NMI-T-I**  
284 x 183 x 17  
mm

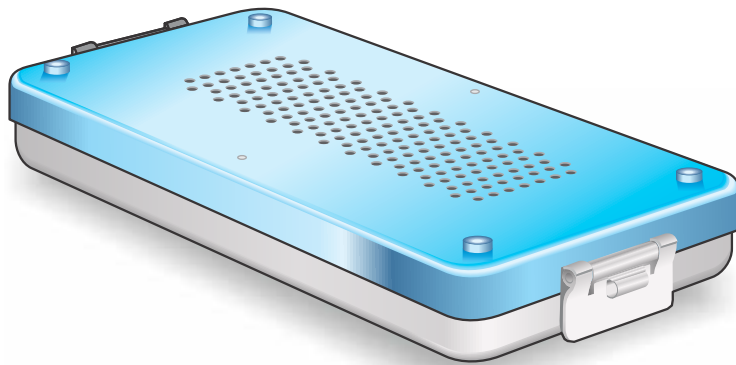


TRAY INOX  
**NMI-T-IF**  
284 x 183 x 17  
mm

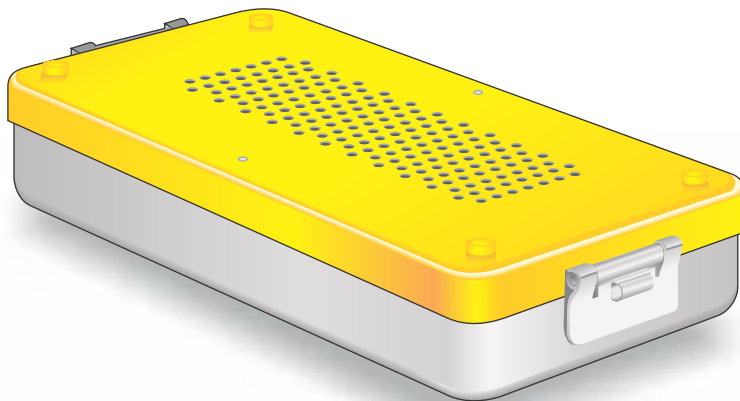


Steril Container  
Sterilization Container  
Contenitori per sterilizzazione  
Contenedores para esterilización  
Conteneurs pour stérilisation

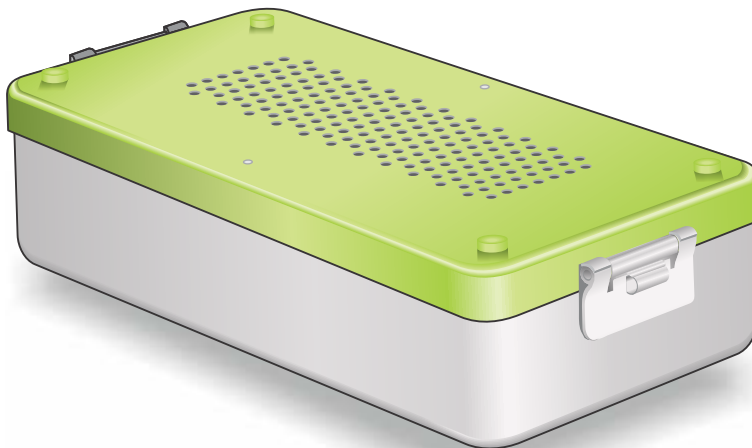
**Stainless Steel - Aluminium**  
Rostfrei - Aluminium  
Acier inoxydable - Aluminium  
Acero inoxidable - Aluminio  
Acciaio inossidabile - Alluminio



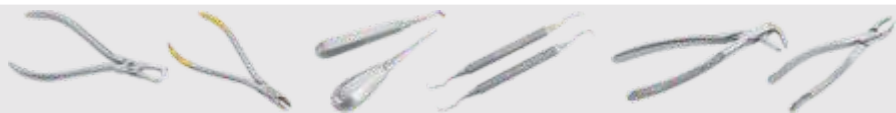
**Small**  
outside: 300 x 140 x 40  
mm inside: 280 x 130 x 27  
mm  
NMI CT-555N NMI-CT-556N  
NMI CT-557N NMI-CT-558N  
NMI CT-559N  
NMI



**Medium**  
outside: 300 x 140 x 70  
mm inside: 280 x 130 x 55  
mm  
NMI CT-560N  
NMI CT-561N  
NMI CT-562N  
NMI CT-563N  
NMI CT-564N



**Large**  
outside: 300 x 140 x 100  
mm inside: 280 x 130 x 84  
mm  
NMI CT-565N  
NMI CT-566N  
NMI CT-567N  
NMI CT-568N  
NMI CT-569N

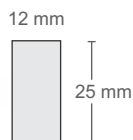


Instrumentenpflege  
Maintenance of instruments  
Mantenimento dello strumentario  
Mantenimiento del instrumental  
Nettoyage d'instruments

*Original Arkansas*

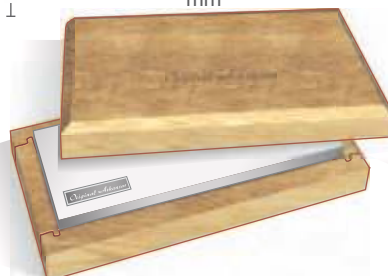
Sharpening  
Stones  
Schleifsteine  
Pierres à aiguiser  
Piedras de afilar  
Pietre per affilare

**NMI-DB-4**  
ARKANSAS #  
4 100 mm



**NMI-DB-299**  
ARKANSAS  
conica # 299  
90 mm  
8 mm

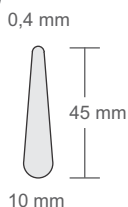
**NMI-DB-96**  
ARKANSAS # 8  
100 x 50 x 13  
mm



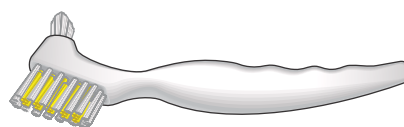
Teflon Stick for sharpening test Teflon-  
Stäbchen für das Schärfe-Test Bastón  
de teflon para probar afilado Bâton  
en teflon pour tester l'aiguisage Bastoncino  
di Teflon per provare affilatura



**NMI-DB-15**  
100 mm  
8 mm



**NMI-DB-6A**  
ARKANSAS # 6A  
100 mm



**NMI-DB-11**  
155 mm



**NMI-DB-12**  
175 mm

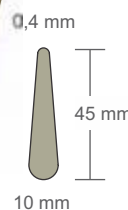
Brushes for instruments  
Instrumente-  
Reinigungsbürsten Brosses  
pour instruments Cepillos para  
instrumentos Spazzolino per

**Lubricating and sharpening oil**

**SHARPEN OIL**

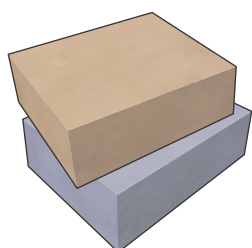
It is a non-coloured oil, which is an indispensable complement for lubricating and manual sharpening of surgical instruments. It should be applied to ensure perfect function and fluid movement of all surgical instruments (on all hinges or all other part which are subject to movement or friction).

Must always be used during all sharpening operations. It is used to activate the abrasive properties of all stones (Arkansas, India, etc.), and to reduce the possibility of overheating the instruments during sharpening.



**NMI-DB-3**  
INDIA # 6  
100 mm

Special Rubber for Metal  
Spezial-Gummi für Metall  
Caoutchouc spécial pour métal  
Goma especial para metal  
Gomme speciali per metalli



**NMI-DB-07 /  
NMI-DB-08**  
Fine / Coarse  
50 x 40 x 20  
mm

**Bacteriostatic Anti-Corrosion Milk**

**CLEANLACT**

**Extends your surgical instrument's lifetime.**

A periodic use of Cleanlact prevents corrosion; it has a bacteriostatic and lubricating action on all instruments; it guarantees perfect maintenance by eliminating eventual stains, halos and browning due to sterilization, disinfection and washing with tap water. Must use periodically, diluted or concentrated (see special instructions on packaging).

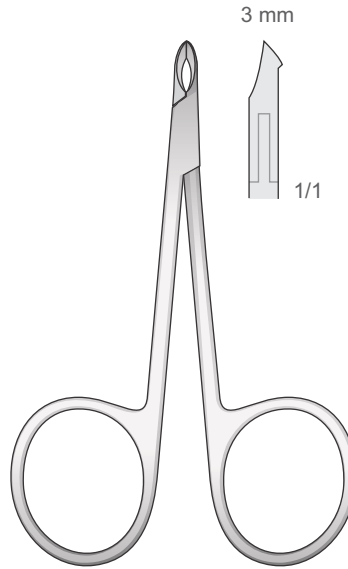


Vorbereitung - Nagel scheren  
Preparation - Nail scissors  
Preparazione - Forbici per unghie  
Preparación - Tijeras para uñas  
Préparation - Ciseaux à ongles

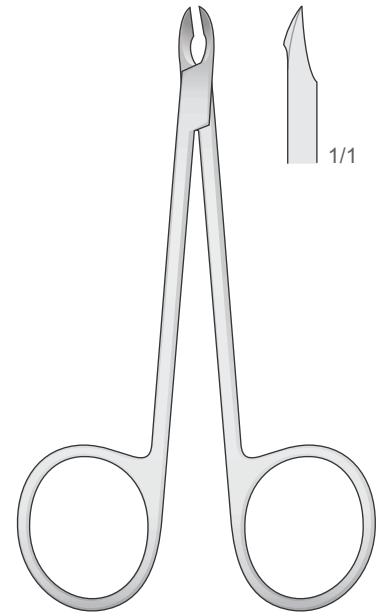
Handwaschbürste  
Nail brushes  
Spazzola per unghie  
Cepillo para uñas  
Brosse à ongles



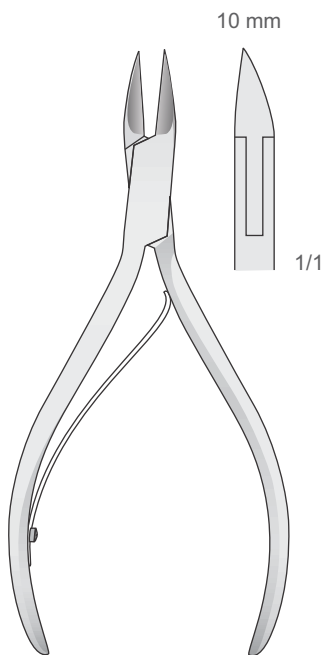
**NMI-GF-200**  
4 x 11 cm  
Autoclavable



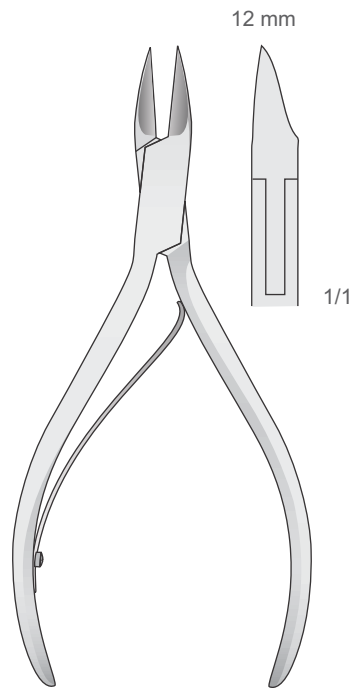
**NMI-GS-40**  
85 mm



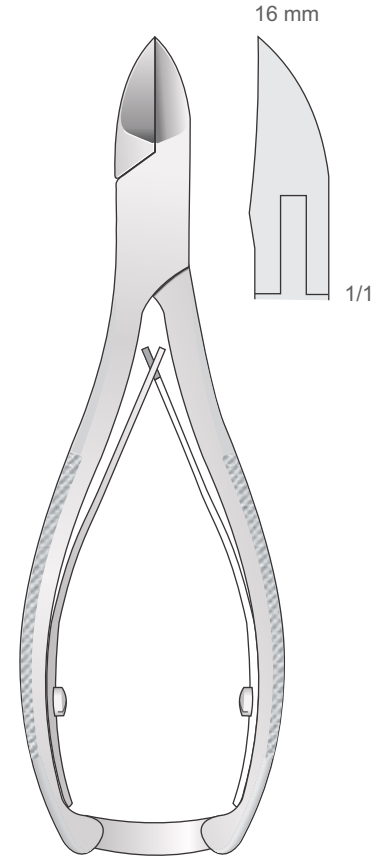
**NMI-GS-52**  
100 mm



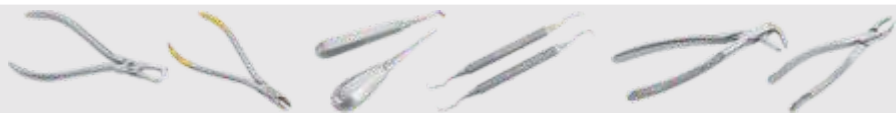
**NMI-GS-42**  
100 mm



**NMI-GS-44**  
110 mm



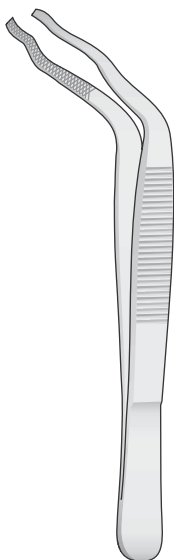
**NMI-GS-48**  
140 mm



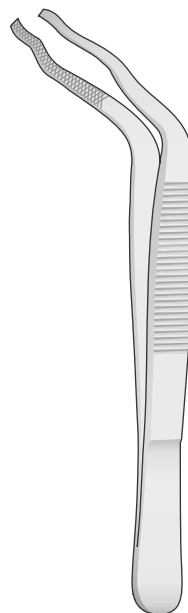
Sterilisierzangen  
Sterilizing Forceps  
Pinze per sterilizzazione  
Pinzas para esterilización  
Pinces pour stérilisation



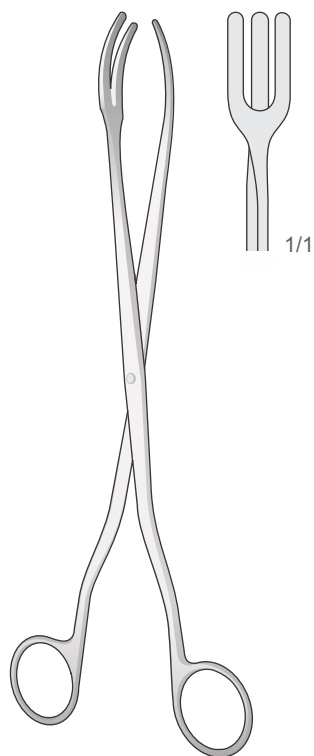
**NMI-GS-02**  
145 mm



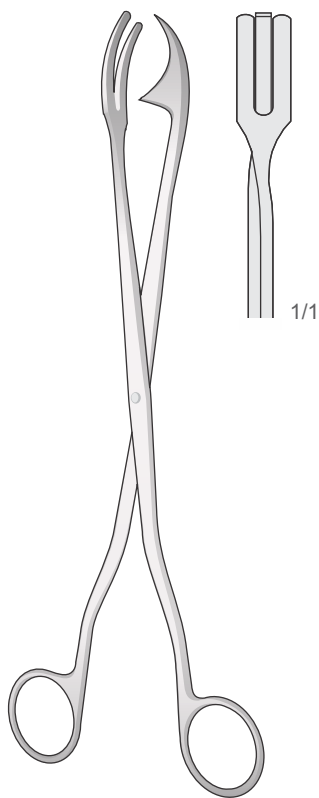
**DAVIS**  
**NMI-GS-03**  
160 mm



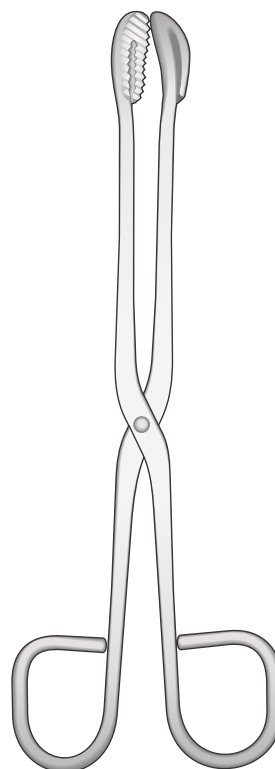
**DAVIS**  
**NMI-GS-04**  
200 mm



**NMI-GS-10**  
200 mm



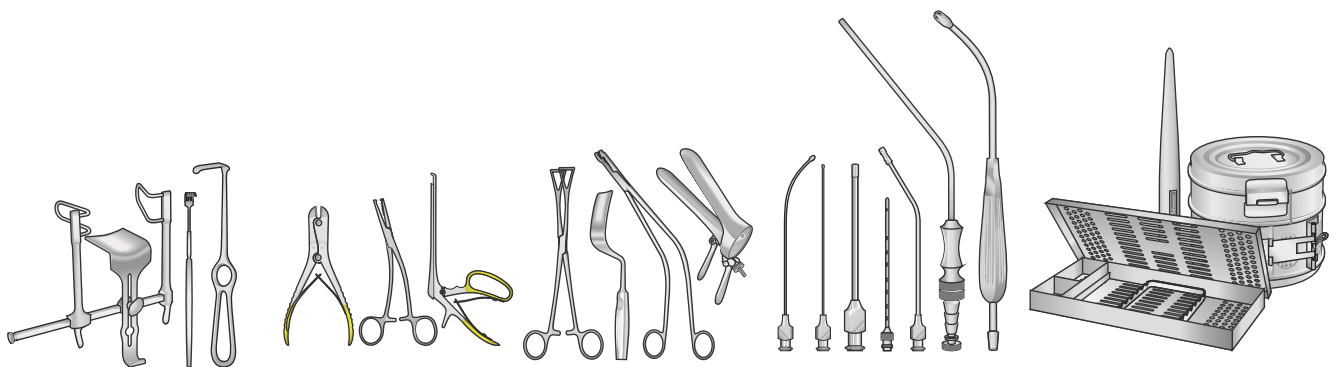
**ROGGE**  
**NMI-GS-06**  
230 mm



**NMI-GS-13**  
200 mm

# NOUMED<sup>®</sup>

I N S T R U M E N T S



**Factory Address: Daska Road, Sadra Badra, Boota Street Sialkot 51310-Pakistan**

**Ph#: +92-52-3557110**

**Fax: +92-52-3557110**

**Email: [info@noumed.com.pk](mailto:info@noumed.com.pk)**

**Web: [www.noumed.com.pk](http://www.noumed.com.pk)**